

VP-152MX2-M16

152 Megapixel Thermoelectric Peltier Cooled Camera
with CoaXPress 2.0 Interface



CoaXPress®

The VP-152MX2-M16, the latest model of the industrial proven VP series, is a new 152-megapixel CoaXPress camera and adopts the cutting-edge High Speed CMOS Image Sensor.

The VP-152MX2-M16 camera offers up to 16.3 frames per second at 16,544 × 9,200 resolution. This camera uses thermoelectric Peltier (TEC) cooling technology developed for and used by many demanding medical market customers. The TEC maintains the operating temperature of the CMOS image sensor at up to 15 degrees below ambient temperature. This camera provides a stable operating condition and the ability to expose for a long period of time to increase camera sensitivity.

Featuring the stable operating capability and high resolution, this camera is ideal for demanding applications such as FPD, PCB and semiconductor inspections.

VIEWORKS

vision.vieworks.com

VP-152MX2-M16

152 Megapixel Thermoelectric Peltier Cooled Camera with CoaXPress 2.0 Interface



Mechanical Dimensions

Unit: mm

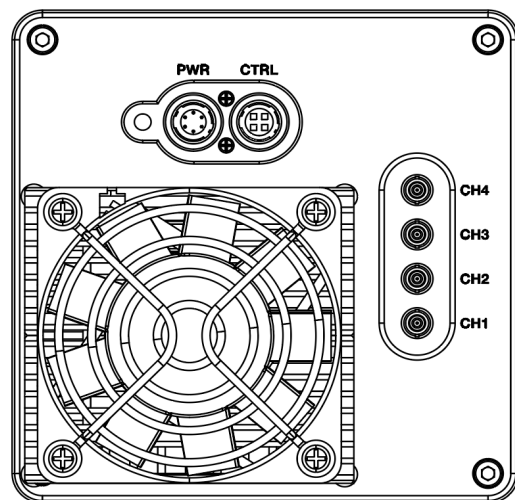
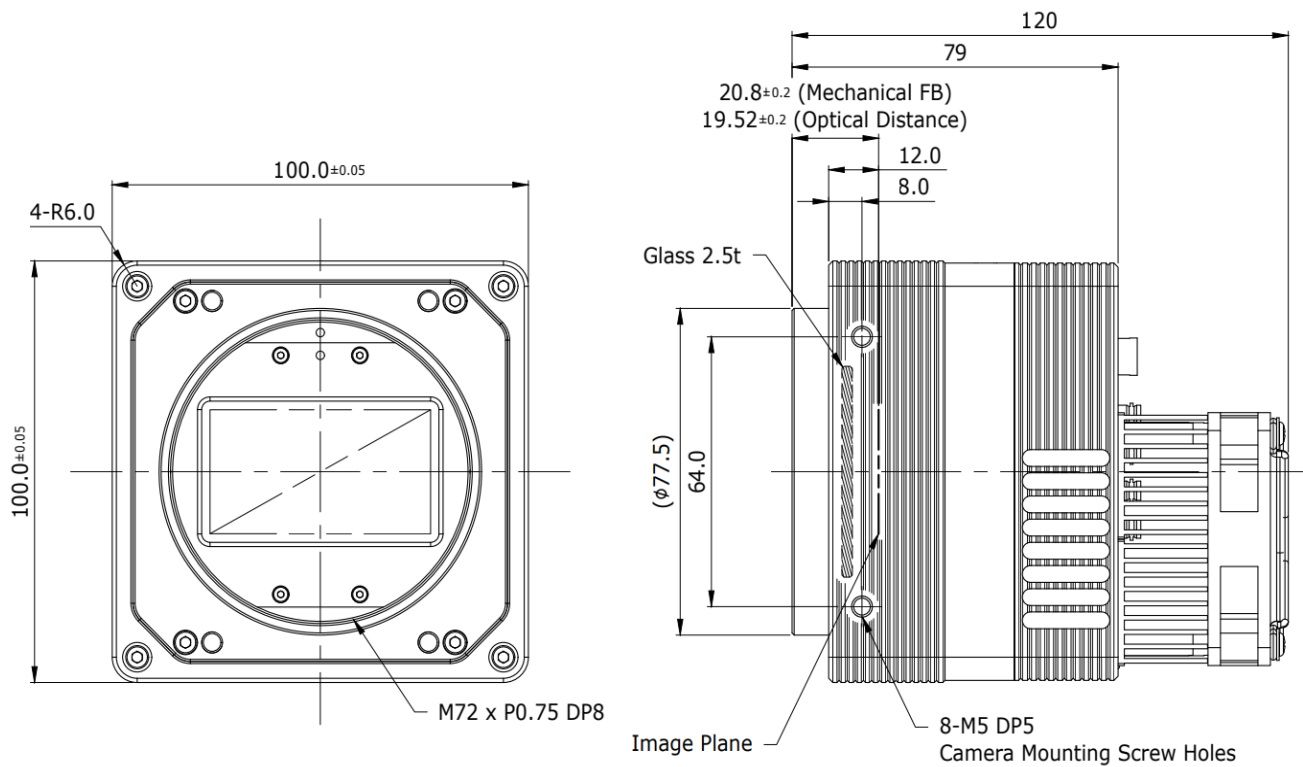

Main Features

- Thermoelectric Peltier Cooled – $15\pm 2^{\circ}\text{C}$ below
- 152 Megapixel Resolution
- CoaXPress 2.0 Interface up to 16.3 fps at 50 Gbps using 4 CH
- Global Shutter CMOS Technology
- DSNU and PRNU Correction
- Flat Field Correction
- GenICam Compatible – XML based Control

Applications

- Flat Panel Display Inspection
- Electronics Inspection
- Semiconductor Inspection
- Document / Film Scanning

Specifications

Model	VP-152MX2-M16	
Resolution (H × V)	16,544 × 9,200	
Sensor Size (Diagonal)	53.0 mm × 29.4 mm (60.6 mm)	
Sensor Type	High Speed CMOS Image Sensor	
Pixel Size	3.2 μm × 3.2 μm	
Interface	CXP-12 × 4	
Max. Frame Rate	CXP-6 × 4	15.6 fps
	CXP-10 × 4	16.3 fps
	CXP-12 × 4	16.3 fps
Exposure Time (1 μs step)	1 μs – 60 s	
Partial Scan (Max. Speed)	704 fps at 4 Lines	
Pixel Data Format	Mono 8 / Mono 10 / Mono 12	
Electronic Shutter	Global Shutter	
Binning	×1, ×2, ×4 (Horizontal and Vertical Independent)	
Gain Control	Analog	1.4× ~ 2.8× (Step 0.1), 3.2× ~ 5.2× (Step 0.4)
	Digital	1× ~ 32×
Black Level Control	0 – 255 LSB at 12 bit	
Trigger Synchronization	Free-Run, Hardware Trigger, Software Trigger or CXP	
External Trigger	3.3 V ~ 24.0 V, 10 mA, Logical Level Input, Optically Isolated	
Software Trigger	Asynchronous, Programmable via Camera API	
Dynamic Range	66 dB	
Cooling Method	Thermoelectric Peltier Cooling	
Cooling Performance	$15\pm 2^{\circ}\text{C}$ below ambient temperature – Standard cooling with a fan	
Dimension / Weight	100.0 mm × 100.0 mm × 116.0 mm, 1,650 g (with M72-mount)	
Temperature	Operating: 0°C ~ 40°C , Storage: -40°C ~ 70°C	
Lens Mount	M72-mount, Custom mount available upon request	
Power	External	11 ~ 24 V DC
	Dissipation	Typ. 32.0 W
Compliance	CE, FCC, KC	
API SDK	Vieworks Imaging Solution 7.X	

Spectral Response

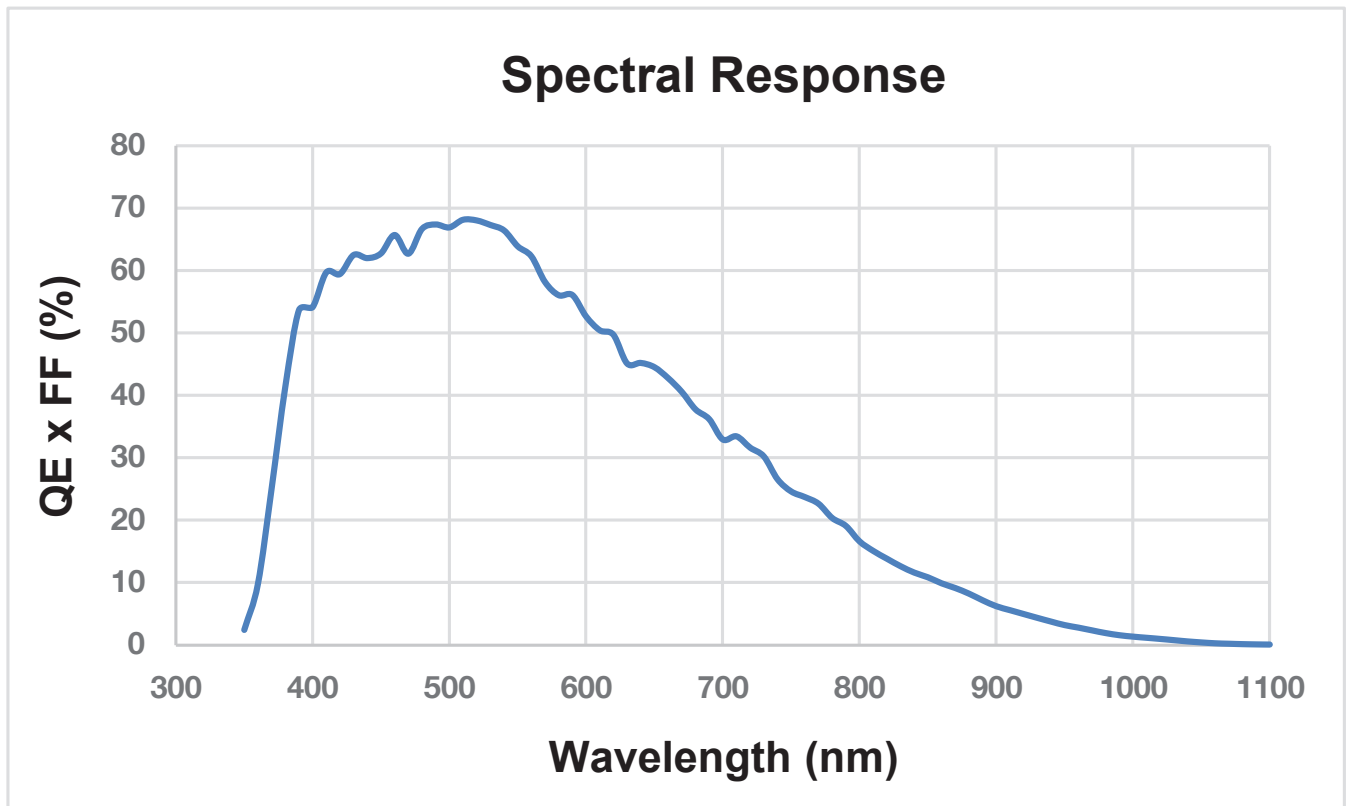

Ordering Scheme

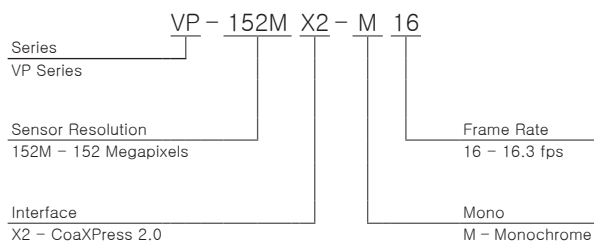

Connector Specification

Power

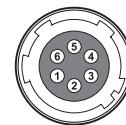

1, 2, 3: +12V DC (HR10A-7R-6PB) 4, 5, 6: GND

Control

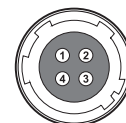

1: Trigger IN+ 2: Trigger IN-
3: Strobe Out-(GND) 4: Strobe Out+ (HR10A-7R-4S)

Data Transfer / Communications

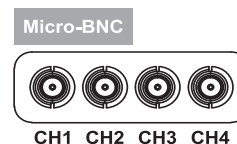

CH1: Master Connection
75 Ω, Micro-BNC (HD-BNC)

Connectors on camera body