

VC series

User Manual

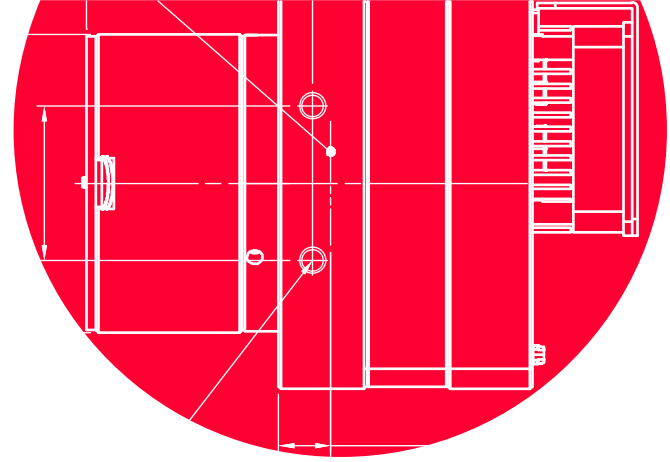

English

VC-61MC-M/C 13 H

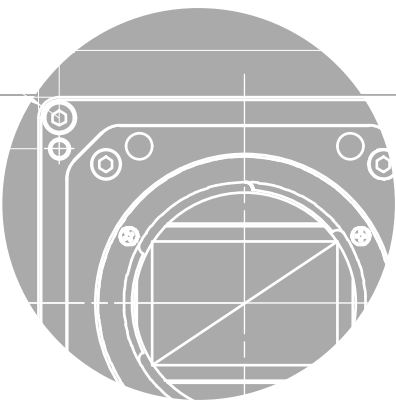

VIEWWORKS

Preface

No part of this manual may either be copied, reproduced, translated, or published in any form or by any means (electronic, mechanical, photocopying, or otherwise) without the express written permission of Vieworks, Co., Ltd. (hereinafter 'Vieworks').

This manual may include the website links to companies other than Vieworks. Vieworks is not responsible for any of these links. The copyrights of the materials mentioned herein are owned by each respective author.

Although Vieworks made every effort to ensure the accuracy of this document, it assumes no responsibility for errors or omissions that may appear herein. The figures in this manual may differ depending on the version of the product or operating system, or the way how it runs. Information in this manual is subject to change without notice.

Before Using This Product

Thank you for choosing a VC-61MC 13H™ camera.

- Make sure to read this manual before using the product.
- Make sure to check whatever a professional engineer has finished installation and configuration.
- Make sure to keep this manual at hand as a reference while using the product.
- This manual assumes that you have expertise in how to use an industrial camera.

The Series

This manual is intended for users of the following products:

- VC-61MC-M13H
- VC-61MC-C13H

About This Manual

This manual is intended for VC-61MC 13H™ camera users. It is recommended to refer to the Frame Grabber's User Manual of yours, with this manual.

Convention in This Manual

For better understanding, the following conventions are used throughout the manual.

Names and Fonts

The names and fonts of user interfaces are used as follows:

- The menu and icon names in this manual are used as displayed in the product.
- The menu and icon names are marked in **this font**.
- Button or keyboard key names are marked in this font.

Warning, Caution, and Note

This manual shows warnings, cautions, and notes with the following figures:

**Warning!**

This indicates that you need to follow this message for your safety and to prevent the product from damage.

**Caution!**

This indicates that you need to follow this message to prevent data from being lost or corrupted.

**Note:**

This indicates that this message provides additional information.

Definition of Terms

For clarity, this manual defines some terms as follows:

Term	Definition
Preface	The introductory part preceding the Table of Contents in this manual

Revision History

This document has the revision history as follows:

Version	Date	Description
1.0	2021-04-28	Initial release
1.1	2021-01-21	Formatted the document template and modified some contents.

Contents

Chapter 1. Precautions	15
Chapter 2. Warranty	17
Chapter 3. Compliance & Certifications	18
3.1 FCC Compliance.....	18
3.2 CE : DoC.....	18
3.3 KC	18
Chapter 4. Package Components.....	19
Chapter 5. Product Specifications.....	20
5.1 Overview.....	20
5.2 Specifications	21
5.3 Camera Block Diagram	22
5.4 Spectral Response	23
5.4.1 Monochrome Spectral Response	23
5.4.2 Color Spectral Response.....	23
5.5 Mechanical Specification	24
5.5.1 Camera Mounting and Heat Dissipation	25
Chapter 6. Connecting the Camera.....	26
6.1 Precaution about Blurring Compared to the Center.....	27
6.2 Controlling the Camera	27
Chapter 7. Camera Interface.....	28
7.1 General Description.....	28
7.2 Camera Link SDR Connector.....	29
7.3 Power Input Receptacle.....	31
7.4 Control I/O Receptacle	32
7.5 Trigger Input Circuit.....	33
7.6 Strobe Output Circuit	33
Chapter 8. Acquisition Control.....	34
8.1 Overview.....	34

8.2	Acquisition Start/Stop Commands and Acquisition Mode.....	35
8.2.1	Acquisition Start/Stop Commands.....	35
8.2.2	Exposure Start Trigger	37
8.2.3	Applying Trigger Signals	38
8.2.4	Exposure Time Control.....	39
8.3	Exposure Start Trigger	39
8.3.1	Trigger Mode	39
8.3.2	Using a Software Trigger Signal.....	43
8.3.3	Using a CC1 Trigger Signal.....	44
8.3.4	Using an External Trigger Signal	45
8.3.5	Exposure Mode	47
8.4	Setting the Exposure Time	49
8.5	Rolling Shutter	50
8.6	Overlapping Exposure with Sensor Readout	52
8.6.1	Overlapped Acquisition with Trigger Mode = Off	52
8.6.2	Non-overlapped Acquisition with Trigger Mode = On.....	53
8.7	Maximum Allowed Frame Rate.....	55
8.7.1	Increasing the Maximum Allowed Frame Rate	56
Chapter 9. Camera Features.....		57
9.1	Region of Interest	57
9.2	Binning (Monochrome Only)	60
9.3	Pixel Format.....	62
9.4	Device Tap Geometry.....	63
9.5	Camera Link Clock	64
9.6	Data ROI (Color Camera).....	65
9.7	White Balance (Color Camera)	66
9.7.1	Balance White Auto	66
9.8	Gain and Black Level	67
9.9	Hot Pixel Correction	67

9.10	Defective Pixel Correction	68
9.10.1	Correction Method.....	68
9.11	Photo Response Non-uniformity Correction	69
9.12	Flat Field Correction.....	70
9.12.1	Flat Field Data Selector	73
9.13	Sequencer Control	75
9.14	Digital I/O Control	77
9.14.1	Strobe.....	79
9.14.2	Debounce	80
9.15	Timer Control	81
9.16	Cooling Control.....	83
9.17	Temperature Monitor.....	83
9.18	Status LED.....	83
9.19	Test Pattern	84
9.20	Reverse X.....	86
9.21	Device Link Throughput Limit.....	87
9.22	Device User ID	87
9.23	Device Reset	87
9.24	Field Upgrade.....	88
9.25	User Set Control.....	88
Chapter 10. Camera Configuration		90
10.1	Serial Communication.....	90
10.2	Actual Runtime of Parameters	91
10.3	Configurator	92
10.4	Command List	95
Chapter 11. Troubleshooting		102
Appendix A. Defective Pixel Map Download		103
Appendix B. Field Upgrade.....		104
Appendix C. Index		105

Tables

Table 5-1	Specifications of the VC-61MC 13H	21
Table 7-1	Pin Assignments for Camera Link Connector 1	29
Table 7-2	Pin Assignments for Camera Link Connector 2.....	30
Table 7-3	Connector Arrangement for the Device Tap Geometry	30
Table 7-4	Pin Configurations for Power Input Receptacle	31
Table 7-5	Pin Configurations for Control I/O Receptacle.....	32
Table 8-1	Minimum and Maximum Exposure Time Setting	49
Table 8-2	Temporal Offset Values depending on the Camera Link Tap Geometry	51
Table 8-3	Max. Allowed Exposure Time and Frame Rate for Non-overlapped Operation	54
Table 9-1	XML Parameters related to ROI	58
Table 9-2	Minimum ROI Width and Height Settings.....	58
Table 9-3	Maximum Frame Rates by the Vertical ROI Changes	59
Table 9-4	XML Parameters related to Binning	60
Table 9-5	XML Parameter related to Pixel Format	62
Table 9-6	Pixel Format Values	62
Table 9-7	XML Parameter related to Device Tap Geometry	63
Table 9-8	XML Parameters related to Camera Link Clock Speed.....	64
Table 9-9	XML Parameters related to Data ROI.....	65
Table 9-10	XML Parameters related to White Balance	66
Table 9-11	XML Parameter related to Balance White Auto	66
Table 9-12	XML Parameters related to Gain and Black Level	67
Table 9-13	XML Parameter related to Hot Pixel Correction	67
Table 9-14	Calculation of Defect Pixel Correction Value	68
Table 9-15	XML Parameters related to Flat Field Correction.....	71

Table 9-16	XML Parameters related to Sequencer Control	75
Table 9-17	XML Parameters related to Digital I/O Control	77
Table 9-18	XML Parameter related to Debounce Time	80
Table 9-19	XML Parameters related to Timer Control.....	81
Table 9-20	XML Parameters related to Cooling Control.....	83
Table 9-21	XML Parameters related to Device Temperature.....	83
Table 9-22	Status LED	83
Table 9-23	XML Parameter related to Test Pattern.....	84
Table 9-24	XML Parameter related to Reverse X	86
Table 9-25	XML Parameter related to Device Link Throughput Limit	87
Table 9-26	XML Parameter related to Device User ID.....	87
Table 9-27	XML Parameter related to Device Reset.....	87
Table 9-28	XML Parameters related to User Set Control	88
Table 10-1	Command List #1	95
Table 10-2	Command List #2	96
Table 10-3	Command List #3	97
Table 10-4	Command List #4	98
Table 10-5	Command List #5	99
Table 10-6	Command List #6	100
Table 10-7	Command List #7	101

Figures

Figure 5-1	Camera Block Diagram.....	22
Figure 5-2	Spectral Response for VC-5M/8M Monochrome Cameras.....	23
Figure 5-3	Spectral Response for Color Cameras.....	23
Figure 5-4	VC-61MC 13H Mechanical Dimension	24
Figure 7-1	VC-61MC 13H' Back Panel.....	28
Figure 7-2	Camera Link Connector.....	29
Figure 7-3	Pin Assignments for Power Input Receptacle	31
Figure 7-4	Pin Assignments for Control I/O Receptacle.....	32
Figure 7-5	Trigger Input Schematic.....	33
Figure 7-6	Strobe Output Schematic	33
Figure 8-1	Exposure Start Triggering.....	37
Figure 8-2	Frame Acquisition with Software Trigger Signal	43
Figure 8-3	External Trigger Delay	46
Figure 8-4	Timed Exposure Mode	47
Figure 8-5	Trigger Overlapped with Timed Exposure Mode	47
Figure 8-6	Trigger Width Exposure Mode	48
Figure 8-7	Rolling Shutter Operation.....	50
Figure 8-8	Overlapped Exposure and Readout	52
Figure 8-9	Non-overlapped Exposure and Readout.....	53
Figure 9-1	Region of Interest.....	57
Figure 9-2	2 × 2 Binning.....	61
Figure 9-3	VC-61MC 13H Pixel Format.....	62
Figure 9-4	Device Tap Geometry	63
Figure 9-5	Effective Data ROI.....	65

Figure 9-6	Location of Defect Pixel to be corrected	68
Figure 9-7	PRNU Correction	69
Figure 9-8	Generation and Application of Flat Field Data.....	72
Figure 9-9	Bilinear Interpolated Magnification.....	72
Figure 9-10	Flat Field Data Selector.....	73
Figure 9-11	Sequencer Diagram (Use Case).....	76
Figure 9-12	User Output	78
Figure 9-13	Exposure Active Signal.....	78
Figure 9-14	Strobe Signal	79
Figure 9-15	Debounce	80
Figure 9-16	Timer Signal.....	82
Figure 9-17	Grey Horizontal Ramp.....	84
Figure 9-18	Grey Diagonal Ramp.....	84
Figure 9-19	Grey Diagonal Ramp Moving.....	85
Figure 9-20	Sensor Specific	85
Figure 9-21	Original Image	86
Figure 9-22	Reverse X Image.....	86
Figure 9-23	User Set Control.....	89
Figure 10-1	Actual Runtime of Parameters.....	91
Figure 10-2	Add to list in the Camera Scan window.....	92
Figure 10-3	Device Property	93
Figure 10-4	Configurator Plus and Device Maintenance.....	94

Chapter 1. Precautions

General



- Do not drop, disassemble, repair or alter the device. Doing so may damage the camera electronics and cause an electric shock.
- Do not let children or companion animals touch the device without supervision.
- Stop using the device and contact the nearest dealer or manufacturer for technical assistance if liquid such as water, drinks or chemicals gets into the device.
- Do not touch the device with wet hands. Doing so may cause an electric shock.
- Make sure that the temperature of the camera does not exceed the temperature range specified in [5.2 Specifications](#). Otherwise the device may be damaged by extreme temperature.

Installation and Maintenance



- Do not install in dusty or dirty areas - or near an air conditioner or heater to reduce the risk of damage to the device.
- Avoid installing and operating in an extreme environment where vibration, heat, humidity, dust, strong magnetic fields, explosive/corrosive mists or gases are present.
- Do not apply excessive vibration and shock to the device. This may damage the device.
- Avoid direct exposure to a high intensity light source. This may damage the image sensor.
- Do not install the device under unstable lighting conditions. Severe lighting change will affect the quality of the image produced by the device.
- Do not use solvents or thinners to clean the surface of the device. This can damage the surface finish.

Power Supply



- Applying incorrect power can damage the camera. If the voltage applied to the camera is greater or less than the camera's nominal voltage, the camera may be damaged or operate erratically. Please refer to [5.2 Specifications](#) for the camera's nominal voltage.
 - ※ Vieworks Co., Ltd. does NOT provide power supplies with the devices.
- Make sure the power is turned off before connecting the power cord to the camera. Otherwise, damage to the camera may result.

Cleaning the Sensor Surface

Avoid cleaning the surface of the camera's sensor if possible. If you have dust or foreign matter on the sensor surface that will not blow off, use a soft lint free cotton bud dampened with a small quantity of high quality lens cleaner. Because electrostatic discharge (ESD) can damage the sensor, you must use a cloth (e.g. cotton) that will not generate static during cleaning.



Avoid dust or foreign matter on the sensor surface.

The camera is shipped with a protective plastic seal on the camera front. To prevent collecting dust or foreign matter on the camera sensor, make sure that you always put a plastic protective seal in place when there is no lens mounted on the camera. In addition, make sure to always point the camera downward when there is no protective seal on the camera front or no lens mounted.

Procedures for Cleaning the Sensor

If you have dust or foreign matter on the sensor surface, follow the procedures below to wipe off.

1. Remove a contaminant by using an ionizing air gun.
If this step does not remove the contaminant, proceed to the next step.
2. Clean the contaminant on the sensor using one drop of lens cleaner on a non-fluffy cotton bud.
3. Wipe the cotton bud gently in only one direction (either left to right or right to left). Avoid wiping back and forth with the same cotton bud in order to ensure that the contaminants are removed and not simply transferred to a new location on the sensor surface.
4. Mount a lens, set the lens at a smaller aperture (e.g. F8), and then acquire images under bright lighting conditions. Check the images on the monitor for dark spots or stripes caused by the contaminant. Repeat the steps above until there is no contaminant present.



Caution!

If the sensor is damaged due to electrostatic discharge or the sensor surface is scratched during cleaning, the warranty is void.

Chapter 2. Warranty

Do not open the housing of the camera. The warranty becomes void if the housing is opened. For information about the warranty, please contact your local dealer or factory representative.

Chapter 3. Compliance & Certifications

3.1 FCC Compliance

This equipment has been tested and found to comply with the limits for a Class A digital device, pursuant to part 15 of the FCC Rules. These limits are designed to provide reasonable protection against harmful interference when the equipment is operated in a commercial environment. This equipment generates, uses, and can radiate radio frequency energy and, if not installed and used in accordance with the instruction manual, may cause harmful interference to radio communications. Operation of this equipment in a residential area is likely to cause harmful interference in which case the user will be required to correct the interference at his own expenses.

3.2 CE : DoC

EMC Directive 2014/30/EU

EN 55032:2012 (Class A), EN 55024:2010

Class A

3.3 KC

KCC Statement

Type	Description
Class A (Broadcasting Communication Device for Office Use)	This device obtained EMC registration for office use (Class A), and may be used in places other than home. Sellers and/or users need to take note of this.

Chapter 4. Package Components

Package Components



A VC-61MC 13H camera

Chapter 5. Product Specifications

5.1 Overview

The VC-61MC 13H, the latest model of the industrial proven VC series, is a new 61 megapixel CMOS camera available with the Camera Link interface. This camera is based on the latest CMOS image sensor technology (IMX455) from Sony Semiconductor Solutions Corporation. The VC-61MC 13H offers up to 13 frames per second at 9568 × 6380 resolution. Equipped with the Viewworks' innovative technologies proved by world's top FPD manufacturers, the VC-61MC 13H camera offers not only highly uniformed images but also high-speed image processing capabilities. Featuring high quality image uniformity and high speed, this camera is ideal for demanding applications such as FPD, PCB and semiconductor inspections.

Main Features

- High Speed 61 Megapixel CMOS Image Sensor
- Electronic Exposure Time Control (Rolling Shutter)
- Output Pixel Format: 8/10/12 bit
- Line Output
- Defective Pixel Correction
- Camera Link Base / Medium / Full / 10 Tap
- Camera Link Clock Frequency Selector
- Gain / Black Level Control
- Test Pattern
- Temperature Monitor
- Field Upgrade
- DSNU and PRNU Correction
- Flat Field Correction with Sequencer Control
- Hot Pixel Correction
- GenICam Compatible – XML based Control

5.2 Specifications

Technical specifications for the VC-61MC 13H are as follows.

Specifications	VC-61MC-M/C 13 H	
Active Image (H × V)	9568 × 6380	
Sensor	Sony IMX455	
Sensor Type	Back-Illuminated CMOS Image Sensor	
Max. Image Circle	Diagonal 43.3 mm (Type 2.7)	
Pixel Size	3.76 μm × 3.76 μm	
Interface	Camera Link Base / Medium / Full / 10 Tap	
Electronic Shutter	Rolling Shutter	
Max. Frame Rate	2 Tap	2.7 fps
	4 Tap	5.5 fps
	8 Tap	10.9 fps
	10 Tap	13.6 fps
Pixel Data Format	Mono	Mono 8 / Mono 10 / Mono 12
	Color	RG Bayer 8 / RG Bayer 10 / RG Bayer 12
Camera Link Pixel Clock	65 MHz / 85 MHz	
Exposure Time (2-Line step)	2 Tap	112.77 μs ~ 60 s
	4 Tap	56.47 μs ~ 60 s
	8 Tap	28.33 μs ~ 60 s
	10 Tap	22.72 μs ~ 60 s
Partial Scan (Max. Speed)	1569.85 fps at 4 Lines	
Binning	Sensor	×1, ×2, ×3 (Horizontal and Vertical Dependent)
	Logic	×1, ×2, ×4 (Horizontal and Vertical Independent)
Black Level Control	0 ~ 255 LSB at 12 bit	
Gain Control	Analog	1× ~ 32×
	Digital	1× ~ 32×
Trigger Synchronization	Overlapped	Free-Run
	Non-overlapped	Hardware Trigger, Software Trigger, CC1 or User Output0
External Trigger	3.3 V ~ 24.0 V, 10 mA, Logical level input, Optically isolated	
Software Trigger	Asynchronous, Programmable via Camera API	
Dynamic Range	78 dB	
Lens Mount	F-mount	
Power	External	11 ~ 24 V DC
	Dissipation	Typ. 16.0 W
Environmental	Operating: 0 ~ 40°C, Storage: -40°C ~ 70°C	
Dimension / Weight	80.0 mm × 80.0 mm × 107.0 mm, 744 g (with F-mount)	
Configuration SW	Configurator / Vieworks Imaging Solution 7.X	

Table 5-1 Specifications of the VC-61MC 13H

5.3 Camera Block Diagram

The block diagram of the VC-61MC 13H is shown below.

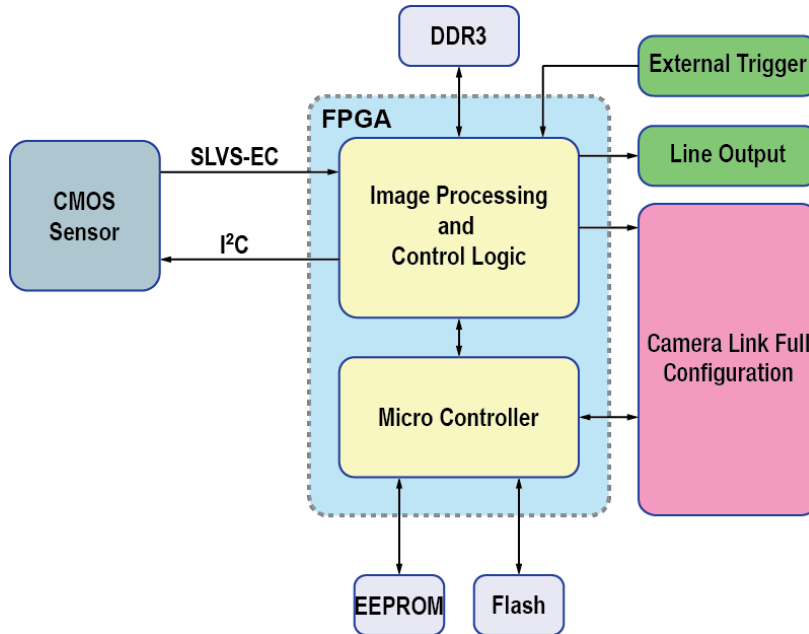

Figure 5-1 Camera Block Diagram

All controls and data processing of a camera in the VC-61MC 13H are carried out in one FPGA chip. The FPGA generally consists of a 32-bit RISC Micro-Controller and Processing & Control logic. The Micro-Controller receives commands from the user through the Camera Link interface and then processes them. The Processing & Control logic processes the image data received from the CMOS image sensor and then transmits data through the Camera Link interface. The Processing & Control logic also controls time-sensitive trigger inputs and output signals. Furthermore, Flash and DDR3 are installed outside FPGA. The DDR3 is used for the frame buffer to process images and the Flash stores the firmware to operate the Micro-Controller.

5.4 Spectral Response

5.4.1 Monochrome Spectral Response

The following graphs show the spectral response of the monochrome camera of the VC-61MC 13H series.

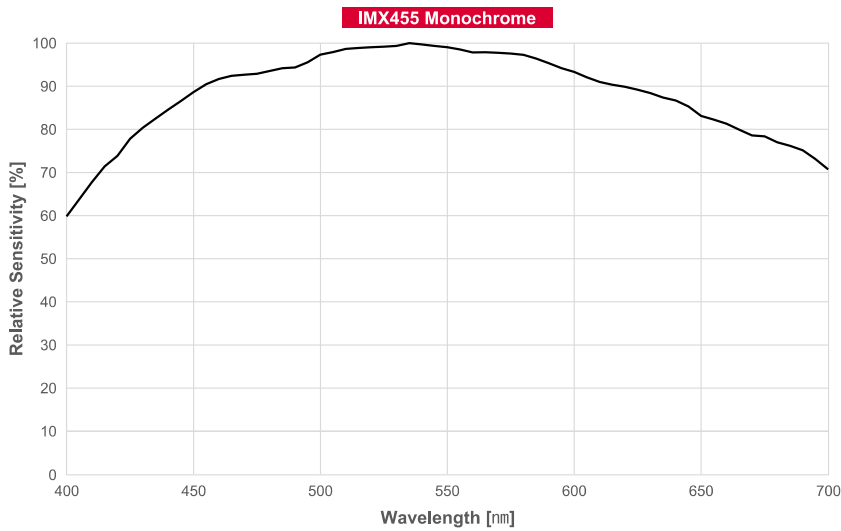

Figure 5-2 Spectral Response for VC-5M/8M Monochrome Cameras

5.4.2 Color Spectral Response

The following graphs show the spectral response of the color camera of the VC-61MC 13H series.

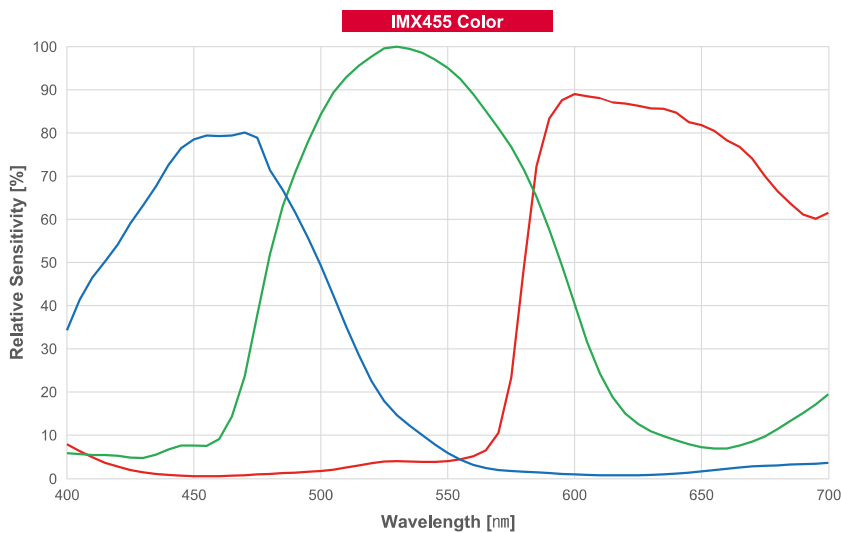

Figure 5-3 Spectral Response for Color Cameras

5.5 Mechanical Specification

The camera dimensions in millimeters are shown in the following figure.

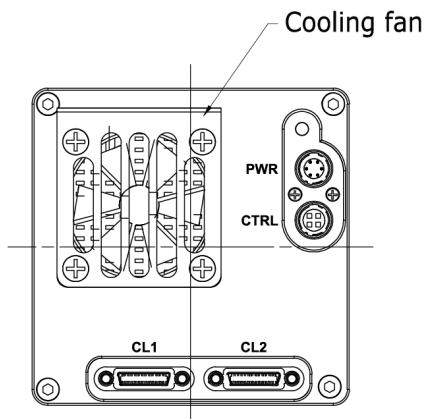
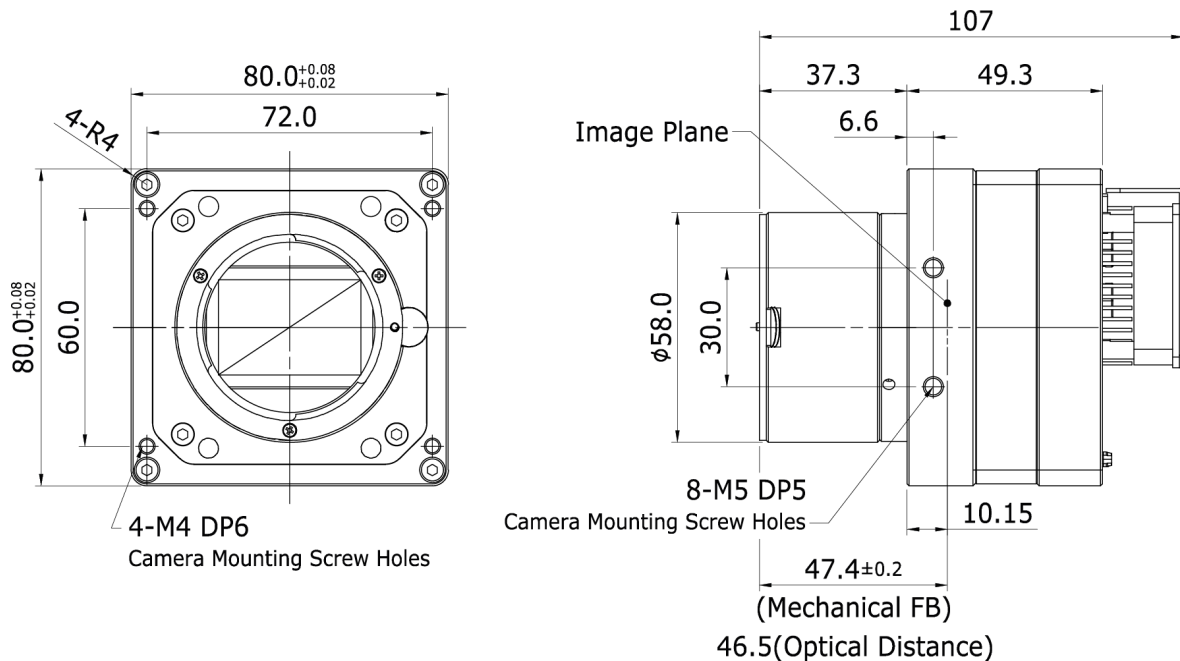

Figure 5-4 VC-61MC 13H Mechanical Dimension

5.5.1 Camera Mounting and Heat Dissipation

Camera Mounting Recommendations for Antivibration

When you mount a camera in a poor condition, the fan equipped on the camera may amplify vibrations which can lead to blurry images. Follow the instructions below to prevent and/or reduce vibrations caused by the fan.

- Fix the camera's front or side surface by using at least four screws.
- Prevent ingress of foreign objects between the camera and system surfaces.
- Keep the camera's center of gravity as near as possible to the system's center of gravity.
- If your lens' weight or size is greater than the camera's, make and use proper mounting brackets to support the lens.
- Prevent foreign matters from falling into the fan. This may cause damage to the fan blades.

Camera Mounting Recommendations for Effective Heat Dissipation

- Do not obstruct the air inlets and outlets of the fan.
- If the fan is not available, leave enough space around the heat sink so that heat can be easily dissipated through the heat sink by natural convection.
- If the fan is not available, mount the camera on a metal structure made of high thermal conductive materials (e.g. Aluminum) to properly dissipate the heat generated by the camera.
- The contact surface of the camera must be at least 30% of the camera's Front-Block.

Chapter 6. Connecting the Camera

The following instructions assume that you have installed a Camera Link frame grabber in your computer including related software. For more information, refer to your Camera Link frame grabber user manual.

To connect the camera to your computer, follow the steps below:

1. Make sure that the power supply is not connected to the camera and your computer is turned off.
2. Plug one end of a Camera Link cable into the Camera Link1 connector on the camera and the other end of the Camera Link cable into the Base connector on the Camera Link frame grabber.
3. Plug one end of the other Camera Link cable into the Camera Link2 connector on the camera and the other end of the Camera Link cable into the Medium/Full connector on the Camera Link frame grabber.
4. Connect the plug of the power adapter to the power input receptacle on the camera.
5. Plug the power adapter into a working electrical outlet.
6. Verify all the cable connections are secure.

Precautions for using Camera Link Medium / Full / 10 Tap Configuration



Caution!

The VC-61MC 13H supports the Camera Link Base / Medium / Full / 10 Tap configuration. To operate the camera in the medium, full or 10 tap configuration, you must connect the camera to the Camera Link frame grabber using two Camera Link cables. Make sure that you connect both Camera Link1 (Base) and Camera Link2 (Medium/Full) connectors on the camera to their respective connectors on the Camera Link frame grabber.

6.1 Precaution about Blurring Compared to the Center

- Users do not need to adjust the tilt as it is adjusted as factory default settings.
- If the tilt settings need to be adjusted inevitably, please contact your local dealer or factory representative for technical support.

6.2 Controlling the Camera

- You can control the camera by using the Configurator.
- You may be able to download the latest Configurator by contacting the manufacturer of your frame grabber.
- Please refer to your Camera Link frame grabber user manual.

Chapter 7. Camera Interface

7.1 General Description

As shown in the following figure, three types of connectors and an LED indicator are located on the back of the camera and have the functions as follows:

- | | |
|--|---|
| ① Status LED: | displays power status and operation mode. |
| ② 6 pin Power Input Receptacle: | supplies power to the camera. |
| ③ 4 pin Control I/O Receptacle: | provides access to the camera's I/O lines. |
| ④ 26 pin SDR Connector 1(Camera Link Base): | transmits video data and controls the camera. |
| ⑤ 26 pin SDR Connector 2(Camera Link Medium/Full): | transmits video data. |

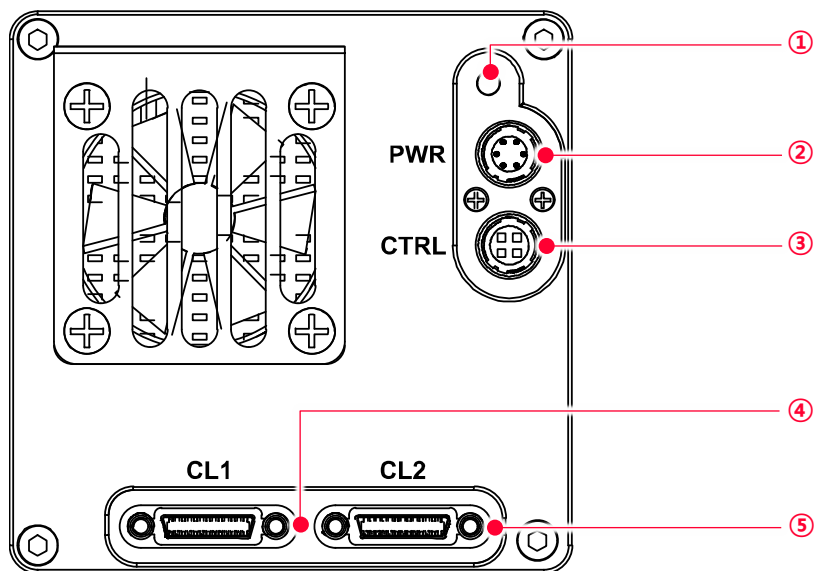

Figure 7-1 VC-61MC 13H' Back Panel

7.2 Camera Link SDR Connector

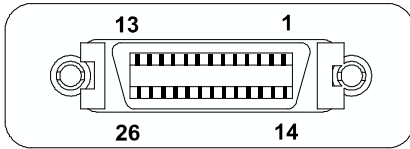

Figure 7-2 Camera Link Connector

The Camera Link connectors on the camera comply with the Camera Link standard and the following lists show the pin assignments of the connectors.

PAIR List	Pin	Signal Name	Type	Description
PAIR 0	1	Ground	Ground	Cable Shield
	14	Ground	Ground	Cable Shield
PAIR 1	2	-X0	LVDS - Out	Camera Link Transmitter
	15	+X0	LVDS - Out	Camera Link Transmitter
PAIR 2	3	-X1	LVDS - Out	Camera Link Transmitter
	16	+X1	LVDS - Out	Camera Link Transmitter
PAIR 3	4	-X2	LVDS - Out	Camera Link Transmitter
	17	+X2	LVDS - Out	Camera Link Transmitter
PAIR 4	5	-XCLK	LVDS - Out	Camera Link Transmitter
	18	+XCLK	LVDS - Out	Camera Link Transmitter
PAIR 5	6	-X3	LVDS - Out	Camera Link Transmitter
	19	+X3	LVDS - Out	Camera Link Transmitter
PAIR 6	7	+ SerTC	LVDS - In	Serial Data Receiver
	20	- SerTC	LVDS - In	Serial Data Receiver
PAIR 7	8	- SerTFG	LVDS - Out	Serial Data Transmitter
	21	+ SerTFG	LVDS - Out	Serial Data Transmitter
PAIR 8	9	- CC 1	LVDS - In	Software External Trigger
	22	+ CC 1	LVDS - In	Software External Trigger
PAIR 9	10	N/C	N/C	N/C
	23	N/C	N/C	N/C
PAIR 10	11	N/C	N/C	N/C
	24	N/C	N/C	N/C
PAIR 11	12	N/C	N/C	N/C
	25	N/C	N/C	N/C
PAIR 12	13	Ground	Ground	Cable Shield
	26	Ground	Ground	Cable Shield

Table 7-1 Pin Assignments for Camera Link Connector 1

PAIR List	Pin	Signal Name	Type	Description
PAIR 0	1	Ground	Ground	Cable Shield
	14	Ground	Ground	Cable Shield
PAIR 1	2	-Y0	LVDS - Out	Camera Link Transmitter
	15	+Y0	LVDS - Out	Camera Link Transmitter
PAIR 2	3	-Y1	LVDS - Out	Camera Link Transmitter
	16	+Y1	LVDS - Out	Camera Link Transmitter
PAIR 3	4	-Y2	LVDS - Out	Camera Link Transmitter
	17	+Y2	LVDS - Out	Camera Link Transmitter
PAIR 4	5	-YCLK	LVDS - Out	Camera Link Transmitter
	18	+YCLK	LVDS - Out	Camera Link Clock Tx
PAIR 5	6	-Y3	LVDS - Out	Camera Link Channel Tx
	19	+Y3	LVDS - Out	Camera Link Channel Tx
PAIR 6	7	-	Not Used	Connected with 100 ohm
	20	-	Not Used	
PAIR 7	8	-Z0	LVDS - Out	Camera Link Transmitter
	21	+Z0	LVDS - Out	Camera Link Transmitter
PAIR 8	9	-Z1	LVDS - Out	Camera Link Transmitter
	22	+Z1	LVDS - Out	Camera Link Transmitter
PAIR 9	10	-Z2	LVDS - Out	Camera Link Transmitter
	23	+Z2	LVDS - Out	Camera Link Transmitter
PAIR 10	11	-ZCLK	LVDS - Out	Camera Link Transmitter
	24	+ZCLK	LVDS - Out	Camera Link Clock Tx
PAIR 11	12	-Z3	LVDS - Out	Camera Link Channel Tx
	25	+Z3	LVDS - Out	Camera Link Channel Tx
PAIR 12	13	Ground	Ground	Cable Shield
	26	Ground	Ground	Cable Shield

Table 7-2 Pin Assignments for Camera Link Connector 2

Model	Device Tap Geometry	CL Configuration	CL Connector 1	CL Connector 2
VC-61MC 13H	2 Tap	BASE	○	X
	4 Tap	MEDIUM	○	○
	8 Tap	FULL	○	○
	10 Tap	10 Tap	○	○

Table 7-3 Connector Arrangement for the Device Tap Geometry



Note:

When you connect a Camera Link frame grabber to the Camera Link connectors on the camera using Camera Link cables, make sure you connect the cables to their correct connectors. If you connect the Camera Link connector 1 on the camera to a connector other than connector 1 of the Camera Link frame grabber, the camera may not transmit images correctly or the serial communication between the camera and the computer may fail.

7.3 Power Input Receptacle

The power input receptacle is a 6-pin connector (part # HR10A-7R-6PB). The pin assignments and configurations are as follows:

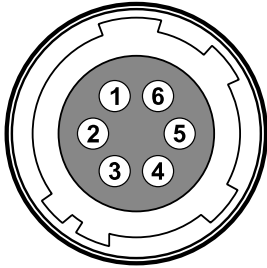

Figure 7-3 Pin Assignments for Power Input Receptacle

Pin Number	Signal	Type	Description
1, 2, 3	+12V DC	Input	DC Power Input
4, 5, 6	DC Ground	Input	DC Ground

Table 7-4 Pin Configurations for Power Input Receptacle



Note:

- A recommended mating connector for the Hirose 6-pin connector is the Hirose 6-pin plug (part # HR10A-7P-6S) or the equivalent.
- It is recommended that you use the power adapter, which has at least 3 A current output at 11 ~ 24 V voltage output (You need to purchase a power adapter separately.).

Precaution for Power Input



Caution!

- Make sure the power is turned off before connecting the power cord to the camera. Otherwise, damage to the camera may result.
- If the voltage applied to the camera is greater than specified in the specifications, damage to the camera may result.

7.4 Control I/O Receptacle

The Control I/O Receptacle is a Hirose 4 pin connector (part # HR10A-7R-4S) and consists of an external trigger signal input and strobe output ports. The pin assignments and configurations are as follows:

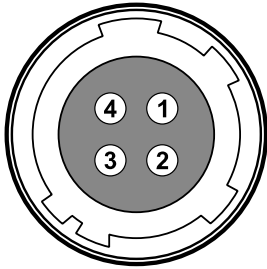

Figure 7-4 Pin Assignments for Control I/O Receptacle

Pin Number	Signal	Type	Description
1	Trigger Input +	Input	3.3 V ~ 24.0 V TTL input
2	Trigger Input -	Input	-
3	DC Ground	-	DC Ground
4	Line1 Output	Output	3.3 V TTL Output Output resistance: 47 Ω

Table 7-5 Pin Configurations for Control I/O Receptacle



Note:

A recommended mating connector for the Hirose 4 pin connector is the Hirose 4 pin plug (part # HR10A-7P-4P) or the equivalent.

7.5 Trigger Input Circuit

The following figure shows trigger signal input circuit of the 6-pin connector. Transmitted trigger signal is applied to the internal circuit through a photo coupler. With the Debounce feature, you can specify the width of input signal to be considered as a valid input signal. An external trigger circuit example is shown below.

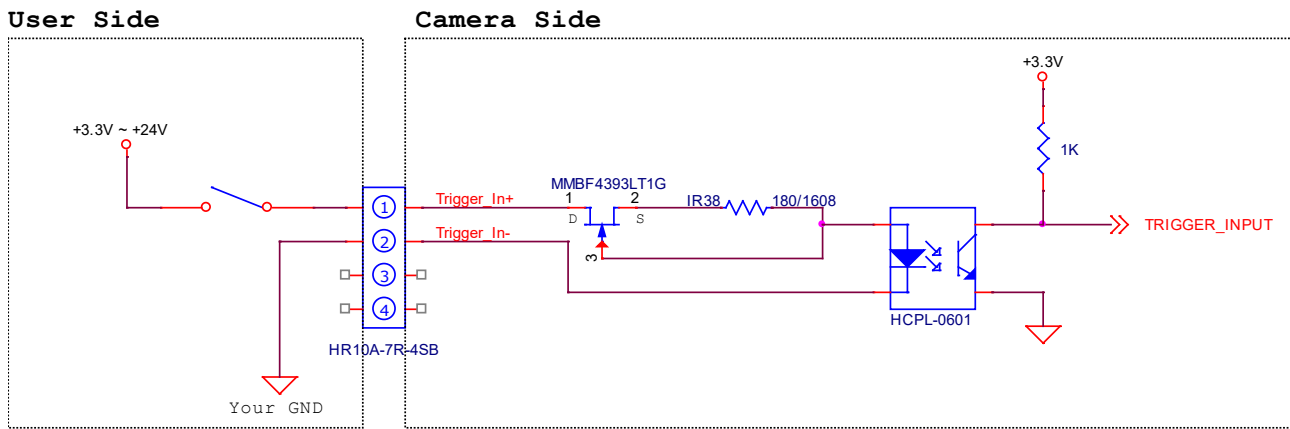

Figure 7-5 Trigger Input Schematic

7.6 Strobe Output Circuit

The strobe output signal comes out through a 3.3 V output level of TTL Driver IC. A pulse width of signal is synchronized with an exposure (shutter) signal of the camera, and comes out.

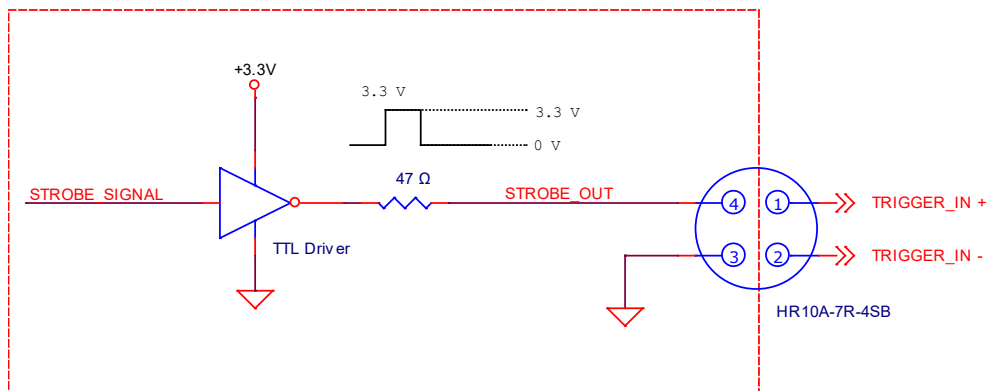

Figure 7-6 Strobe Output Schematic

Chapter 8. Acquisition Control

This chapter provides detailed information about controlling image acquisition.

- Triggering image acquisition
- Setting the exposure time
- Controlling the camera's image acquisition rate
- Variation of the camera's maximum allowed image acquisition rate according to the camera settings

8.1 Overview

This section presents an overview of the elements involved with controlling the acquisition of images.

The followings are involved in controlling the acquisition of images.

- Acquisition Start and **Acquisition Stop** commands and the **Acquisition Mode** parameter
- Exposure start trigger
- Exposure time control
- Frame acquisition process on the camera
- Rolling shutter
- Maximum Allowed Frame Rate



Note:

When reading the explanations in the overview and in this entire chapter, keep in mind that the term "frame" is typically used to mean a single acquired image.

8.2 Acquisition Start/Stop Commands and Acquisition Mode

This section describes function available to use via the followings:

- Acquisition Start/Stop commands
- Acquisition Mode

The details about each item above is described in the order from the following section.

8.2.1 Acquisition Start/Stop Commands

Executing an **Acquisition Start** command prepares the camera to acquire frames. You must execute an **Acquisition Start** command before you can begin acquiring frames. Executing an **Acquisition Stop** command terminates the camera's ability to acquire frames. When the camera receives an **Acquisition Stop** command:

- If the camera is not in the process of acquiring a frame, its ability to acquire frames will be terminated immediately.
- If the camera is in the process of acquiring a frame, the frame acquisition process will be allowed to finish and the camera's ability to acquire new frames will be terminated.



Caution!

When you change the Image ROI, Pixel Format, Device Tap Geometry and Reverse X settings after executing the **Acquisition Start** command, the camera may acquire abnormal images. Change the settings after executing the **Acquisition Stop** command.

The **Acquisition Status** parameter allows you to check whether the camera is in the process of acquiring a frame or not. When you read the **Acquisition Status** parameter while the camera is in the process of acquiring a frame, it will return True or the check box will be selected. When you read the **Acquisition Status** parameter while the camera is not in the process of acquiring a frame, it will return False or the check box will not be selected.

**Note:**

When you execute the Acquisition Start command while the previous frame acquisition process is still in progress, the command will be ignored. To avoid this, you must wait a minimum readout time (refer to Table 8-2) after the execution of the Acquisition Stop command. Then, you can safely execute the Acquisition Start command again.

The VC-61MC 13H camera only provides the **Continuous** mode of operation for the **Acquisition Mode**. After an **Acquisition Start** command has been executed, exposure start can be triggered as desired. Each time an exposure start trigger is applied while the camera is in a waiting for exposure start trigger acquisition status, the camera will acquire and transmit a frame. The camera will retain the ability to acquire frames until an **Acquisition Stop** command is executed. Once the **Acquisition Stop** command is received, the camera will no longer be able to acquire frames.

8.2.2 Exposure Start Trigger

Applying an exposure start trigger signal to the camera will exit the camera from the waiting for exposure start trigger acquisition status and will begin the process of exposing and reading out a frame (see Figure 8-1). As soon as the camera is ready to accept another exposure start trigger signal, it will return to the waiting for exposure start trigger acquisition status. A new exposure start trigger signal can then be applied to the camera to begin another frame exposure. The exposure start trigger has two modes: off and on.

If the **Trigger Mode** parameter is set to **Off**, the camera will generate all required exposure start trigger signals internally, and you do not need to apply exposure start trigger signals to the camera. The rate at which the camera will generate the signals and acquire frames will be determined by the way that you set several frame rate related parameters.

If the **Trigger Mode** parameter is set to **On**, you must trigger exposure start by applying exposure start trigger signals to the camera. Each time a trigger signal is applied, the camera will begin a frame exposure. When exposure start is being triggered in this manner, it is important that you do not attempt to trigger frames at a rate that is greater than the maximum allowed (There is a detailed explanation about the maximum allowed frame rate at the end of this chapter.). Exposure start trigger signals applied to the camera when it is not in a waiting for exposure start trigger acquisition status will be ignored.

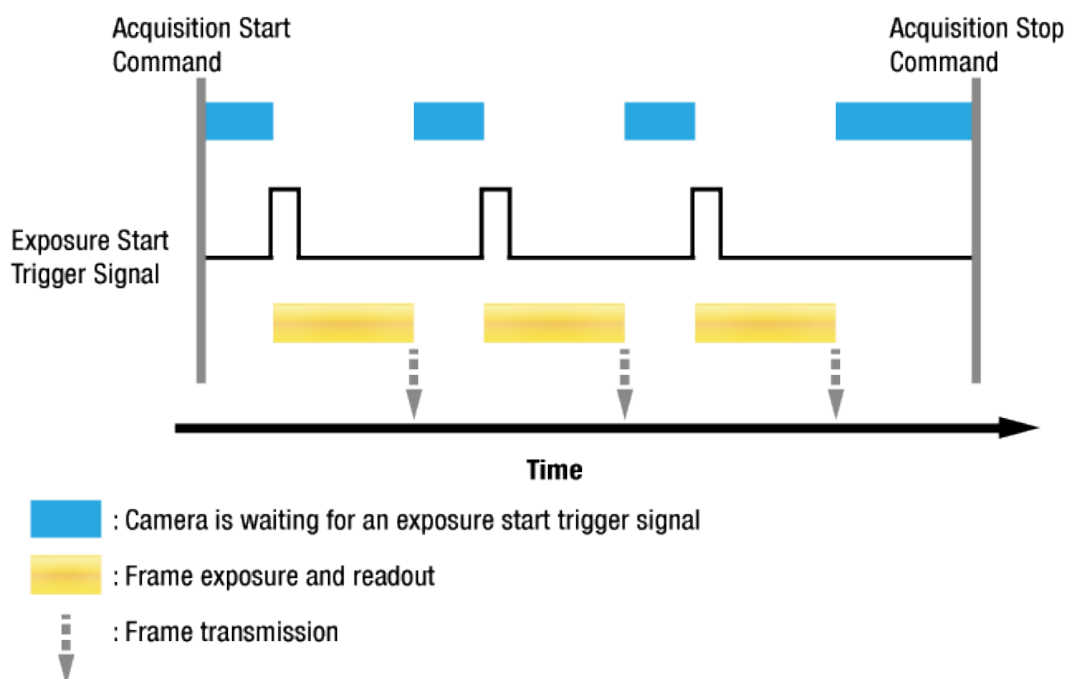

Figure 8-1 Exposure Start Triggering

8.2.3 Applying Trigger Signals

The paragraphs above mention “applying a trigger signal”. There are five ways to apply an exposure start trigger signal to the camera: via **Software**, via **User Output0**, via **CC1**, via **Time0Active**, or via **Line0** (commonly referred to a hardware).

- To apply trigger signals via **Software**, you must set the **Trigger Source** parameter to **Software**. At that point, each time a **Trigger Software** command is executed, the exposure start trigger signal will be applied to the camera.
- To apply trigger signals via **User Output0**, you must set the **Trigger Source** parameter to **User Output0**. At that point, you can apply an exposure start trigger signal to the camera by switching the **User Output Value** parameter between **On** (rise) and **Off** (fall).
- To apply trigger signals via Camera Link frame grabber, you must set the **Trigger Source** parameter to **CC1**. At that point, each time an externally generated electrical signal is applied to the camera by using the APIs provided by a Camera Link frame grabber manufacturer, the exposure start trigger signal will be applied to the camera. For more information, refer to your Camera Link frame grabber user manual.
- To apply trigger signals via the user-defined Timer feature, you must set the **Trigger Source** parameter to **Timer0 Active**. When you set the **Timer Trigger Source** parameter to **Line0** in the **Counter And Timer Control** category, you can apply an exposure start trigger signal to the camera by using a Timer that uses the Line0 signal as the source signal.
- To apply trigger signals via hardware (external), you must set the **Trigger Source** parameter to **Line0**. At that point, each time a proper electrical signal is applied to the camera, an occurrence of the exposure start trigger signal will be recognized by the camera.

8.2.4 Exposure Time Control

When an exposure start trigger signal is applied to the camera, the camera will begin to acquire a frame.

A critical aspect of frame acquisition is how long the pixels in the camera's sensor will be exposed to light during the frame acquisition.

If the Trigger Source parameter is set to **User Output0**, **CC1** or **Line0**, there are two modes of operation: **Timed** and **Trigger Width**.

With the **Timed** mode, the **Exposure Time** parameter will determine the exposure time for each frame.

With the **Trigger Width** mode, the way that you manipulate the rise and fall of the **User Output**, **CC1** or hardware (external) signal will determine the exposure time. The **Trigger Width** mode is especially useful if you want to change the exposure time from frame to frame.

8.3 Exposure Start Trigger

The **Trigger Selector** parameter is used to select a type of trigger and only the **Exposure Start** trigger is available on the VC-61MC 13H camera. The Exposure Start trigger is used to begin frame acquisition. Exposure start trigger signals can be generated within the camera or may be applied externally by setting the **Trigger Source** parameter to **Software**, **User Output0**, **CC1**, **Time0Active**, or **Line0**. If an exposure start trigger signal is applied to the camera, the camera will begin to expose a frame.

8.3.1 Trigger Mode

The main parameter associated with the exposure start trigger is the **Trigger Mode** parameter. The **Trigger Mode** parameter for the exposure start trigger has two available settings: **Off** and **On**.

Trigger Mode = Off

When the **Trigger Mode** parameter is set to **Off**, the camera will generate all required exposure start trigger signals internally, and you do not need to apply exposure start trigger signals to the camera.

If the **Trigger Mode** parameter is set to **Off**, the camera will automatically begin generating exposure start trigger signals when it receives an **Acquisition Start** command. The camera will continue to generate exposure start trigger signals until it receives an **Acquisition Stop** command.



Free-Run

When you set the **Trigger Mode** parameter to **Off**, the camera will generate all required trigger signals internally. When the camera is set this way, it will constantly acquire images without any need for triggering by the user. This use case commonly referred as “free run”.

The rate at which the exposure start trigger signals are generated may be determined by the camera’s **Acquisition Frame Rate** parameter.

- If the parameter is set to a value less than the maximum allowed frame rate with the current camera settings, the camera will generate exposure start trigger signals at the rate specified by the parameter setting.
- If the parameter is set to a value greater than the maximum allowed frame rate with the current camera settings, the camera will generate exposure start trigger signals at the maximum allowed frame rate.

Exposure Time Control with Trigger Mode = Off

When the **Trigger Mode** parameter is set to **Off**, the exposure time for each frame acquisition is determined by the value of the camera’s **Exposure Time** parameter. For more information about the Exposure Time parameter, see [8.4 Setting the Exposure Time](#).

Trigger Mode = On

When the **Trigger Mode** parameter is set to **On**, you must apply an exposure start trigger signal to the camera each time you want to begin a frame acquisition. The **Trigger Source** parameter specifies the source signal that will act as the exposure start trigger signal.

The available settings for the **Trigger Source** parameter are:

- **Software**: You can apply an exposure start trigger signal to the camera by executing a **Trigger Software** command for the exposure start trigger on your computer.
- **User Output0**: You can apply an exposure start trigger signal to the camera by switching the **User Output Value** parameter between **On** and **Off** on your computer.
- **CC1**: You can apply an exposure start trigger signal to the camera via CC1 in the Camera Link interface. For more information, refer to your Camera Link frame grabber user manual.
- **Timer0Active**: You can apply an exposure start trigger signal to the camera using a user defined Timer signal. When you set the **Timer Trigger Source** parameter to **Line0** in the **Counter And Timer Control** category, you can specify a delay for the Line0 signal by using the **Timer Delay** parameter. For more information, refer to **9.15 Timer Control**.
- **Line0**: You can apply an exposure start trigger signal to the camera by injecting an externally generated electrical signal (commonly referred to as a hardware or external trigger signal) into the Control I/O receptacle on the camera. Refer to **7.5 Trigger Input Circuit** for more information.

You must also set the **Trigger Activation** parameter after setting the **Trigger Source** parameter.

The available settings for the **Trigger Activation** parameter are:

- **Falling Edge**: Specifies that a falling edge of the electrical signal will act as the exposure start trigger.
- **Rising Edge**: Specifies that a rising edge of the electrical signal will act as the exposure start trigger.

Exposure Time Control with Trigger Mode = On

When the **Trigger Mode** parameter is set to **On** and the **Trigger Source** parameter is set to **Software**, the exposure time for each frame acquisition is determined by the value of the camera's **Exposure Time** parameter.

When the **Trigger Mode** parameter is set to **On** and the **Trigger Source** parameter is set to **CC1** or **Line0**, the exposure time for each frame acquisition will be determined by the **Exposure Mode** parameter settings as follows:

- **Exposure Mode = Timed:** Exposure time can be controlled with the **Exposure Time** parameter.
- **Exposure Mode = Trigger Width:** Exposure time can be controlled by manipulating the external trigger signal.

When the **Trigger Mode** parameter is set to **On** and the **Trigger Source** parameter is set to **Timer0 Active**, the exposure time for each frame acquisition will be determined by the **Exposure Mode** parameter settings as follows:

- **Exposure Mode = Timed:** Exposure time can be controlled with the **Exposure Time** parameter.
- **Exposure Mode = Trigger Width:** When you set the **Timer Trigger Activation** parameter to **Rising/Falling Edge**, the exposure time is controlled with the **Timer Duration** parameter. When you set the **Timer Trigger Activation** parameter to **Level High/Low**, the exposure time can be controlled by manipulating the external trigger signal.

When the **Trigger Mode** parameter is set to **On** and the **Trigger Source** parameter is set to **User Output0**, the exposure time for each frame acquisition will be determined by the **Exposure Mode** parameter settings as follows:

- **Exposure Mode = Timed:** Exposure time can be controlled with the **Exposure Time** parameter.
- **Exposure Mode = Trigger Width:** Exposure time can be controlled by switching the **User Output Value** parameter between **On** and **Off**.

8.3.2 Using a Software Trigger Signal

If the **Trigger Mode** parameter is set to **On** and the **Trigger Source** parameter is set to **Software**, you must apply a software trigger signal (exposure start) to the camera to begin each frame acquisition. Assuming that the camera is in a **waiting for exposure start trigger** acquisition status, frame exposure will start when the software trigger signal is received by the camera. **Figure 8-2** illustrates frame acquisition with a software trigger signal.

When the camera receives a software trigger signal and begins exposure, it will exit the **waiting for exposure start trigger** acquisition status because at that point, it cannot react to a new exposure start trigger signal. As soon as the camera is capable of reacting to a new exposure start trigger signal, it will automatically return to the **waiting for exposure start trigger** acquisition status.

The exposure time for each acquired frame will be determined by the value of the camera's **Exposure Time** parameter.

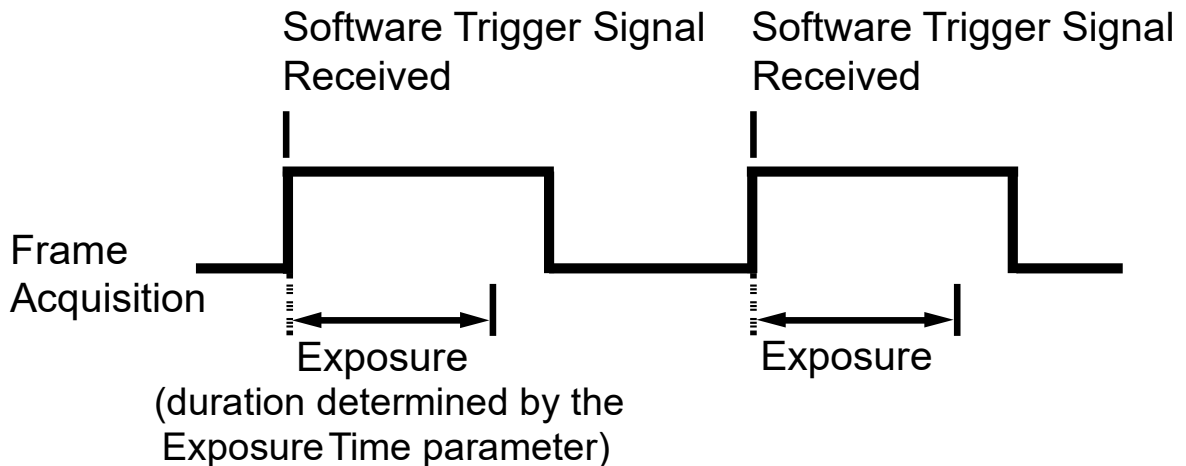

Figure 8-2 Frame Acquisition with Software Trigger Signal

When you are using a software trigger signal to start each frame acquisition, the frame rate will be determined by how often you apply a software trigger signal to the camera, and you should not attempt to trigger frame acquisition at a rate that exceeds the maximum allowed for the current camera settings (There is a detailed explanation about the maximum allowed frame rate at the end of this chapter.). Software trigger signals that are applied to the camera when it is not ready to receive them will be ignored.

8.3.3 Using a CC1 Trigger Signal

If the **Trigger Mode** parameter is set to **On** and the **Trigger Source** parameter is set to **CC1**, you must apply a CC1 trigger signal to the camera to begin each frame acquisition. A CC1 trigger signal will act as the exposure start trigger signal for the camera. For more information, refer to your Camera Link frame grabber user manual.

A rising edge or falling edge of the CC1 signal can be used to trigger frame acquisition. The **Trigger Activation** parameter is used to select rising edge or falling edge triggering. Assuming that the camera is in a waiting for exposure start trigger acquisition status, frame acquisition will start whenever the appropriate edge transition is received by the camera.

The camera starts the exposure after receiving a CC1 trigger signal, however, additional new CC1 trigger signal would be ignored while the previous exposure is still in progress. When the camera is operating under control of a CC1 signal, the period of the CC1 trigger signal will determine the rate at which the camera is acquiring frames:

$$\frac{1}{\text{CC1 signal period in seconds}} = \text{Frame Rate}$$

For example, if you are operating a camera with a CC1 trigger signal period of 500 μs (0.5 s):
So in this case, the frame rate is 2 fps.

**Note:**

Apply 50% duty cycle to your external trigger when using **AnyEdge** in the **TriggerActivation** parameter. By doing this, you will be able to avoid malfunction originated from the different widths of the trigger because of the incorrect setting of the duty cycle. Additionally, it is recommended to use either **RisingEdge** or **FallingEdge** rather than **AnyEdge** in the **TriggerRescaler** parameter.

8.3.4 Using an External Trigger Signal

If the **Trigger Mode** parameter is set to **On** and the **Trigger Source** parameter is set to **Line0**, an externally generated electrical signal injected into the Control I/O receptacle will act as the exposure start trigger signal for the camera. This type of trigger signal is generally referred to as a hardware trigger signal.

A rising edge or a falling edge of the external signal can be used to trigger frame acquisition. The **Trigger Activation** parameter is used to select rising edge or falling edge triggering.

Assuming that the camera is in a *waiting for exposure start trigger* acquisition status, frame acquisition will start whenever the appropriate edge transition is received by the camera.

When the camera receives an external trigger signal and begins exposure, it will exit the *waiting for exposure start trigger* acquisition status because at that point, it cannot react to a new exposure start trigger signal.

As soon as the camera is capable of reacting to a new exposure start trigger signal, it will automatically return to the *waiting for exposure start trigger* acquisition status.

When the camera is operating under control of an external signal, the period of the external trigger signal will determine the rate at which the camera is acquiring frames:

$$\frac{1}{\text{External signal period in seconds}} = \text{Frame Rate}$$

For example, if you are operating a camera with an External trigger signal period of 50 μs (0.05 s):

So in this case, the frame rate is 20 fps.

External Trigger Delay

When you set the **Trigger Source** parameter to **Timer0Active**, you can specify a delay between the receipt of a hardware trigger signal and when the trigger becomes effective.

1. Set the **Timer Trigger Source** parameter in the **Counter And Timer Control** category to **Line0**.
2. Set the **Timer Delay** parameter to the desired Timer delay in microseconds.
3. Set the **Trigger Source** parameter in the **Acquisition Control** category to **Timer0Active**.
4. Execute the **Acquisition Start** command and inject an externally generated electrical signal into the Control I/O receptacle. Then, the delay set by the **Timer Delay** parameter expires and the exposure for image acquisition begins.

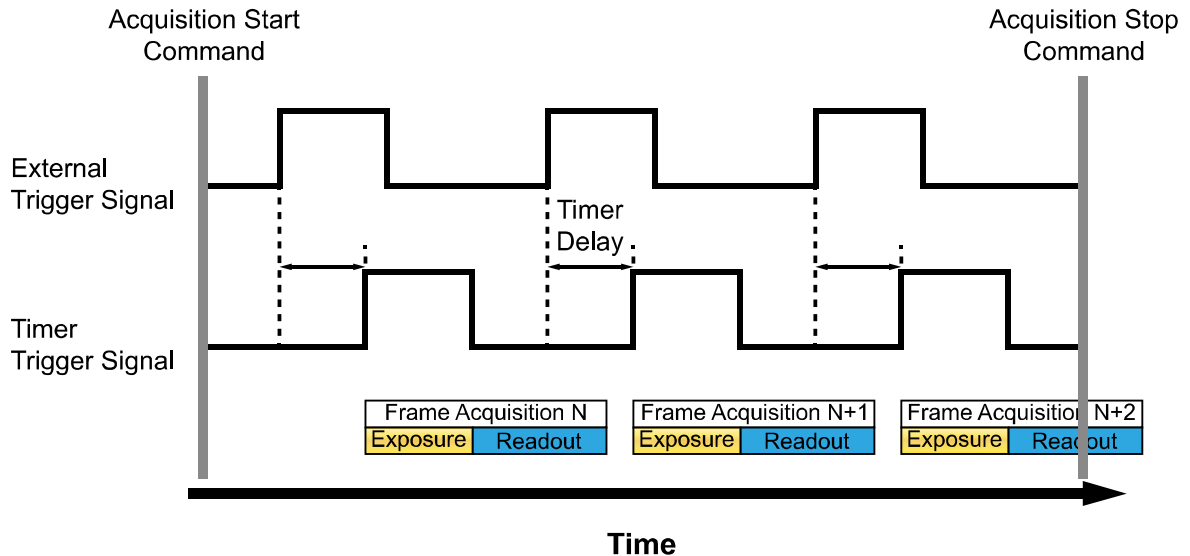

Figure 8-3 External Trigger Delay

8.3.5 Exposure Mode

If you are triggering the start of frame acquisition with an externally (CC1 or External) generated trigger signal, two exposure modes are available: **Timed** and **Trigger Width**.

Timed Exposure Mode

When the **Timed** mode is selected, the exposure time for each frame acquisition is determined by the value of the camera's **Exposure Time** parameter. If the camera is set for rising edge triggering, the exposure time starts when the external trigger signal rises. If the camera is set for falling edge triggering, the exposure time starts when the external trigger signal falls. The following figure illustrates **Timed** exposure with the camera set for rising edge triggering.

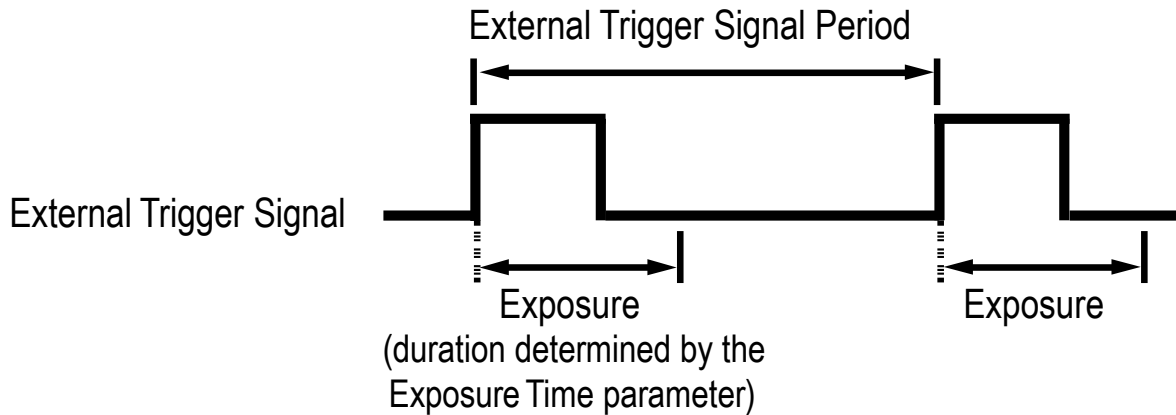

Figure 8-4 Timed Exposure Mode

Note that if you attempt to trigger a new exposure start while the previous exposure is still in progress, the trigger signal will be ignored.

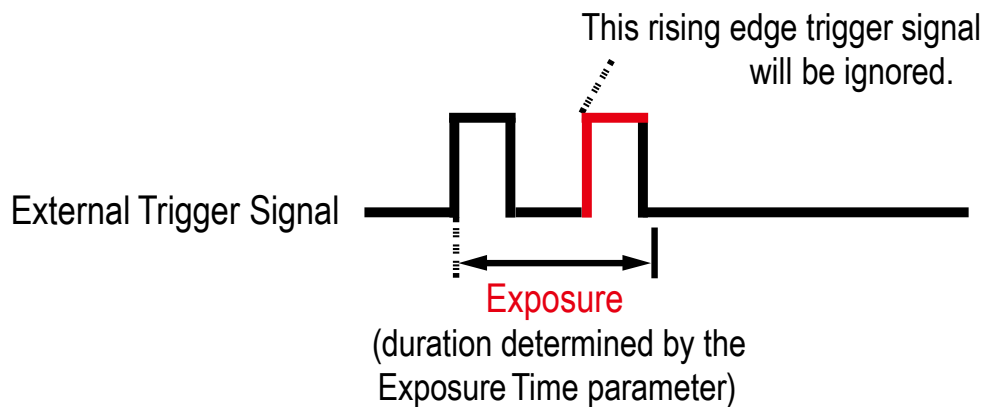

Figure 8-5 Trigger Overlapped with Timed Exposure Mode

Trigger Width Exposure Mode

When the **Trigger Width** exposure mode is selected, the length of the exposure for each frame acquisition will be directly controlled by the external trigger signal (CoaXPress or External). If the camera is set for rising edge triggering, the exposure time begins when the external trigger signal rises and continues until the external trigger signal falls. If the camera is set for falling edge triggering, the exposure time begins when the external trigger signal falls and continues until the external trigger signal rises. The following figure illustrates **Trigger Width** exposure with the camera set for rising edge triggering.

Trigger Width exposure is especially useful if you intend to vary the length of the exposure time for each frame.

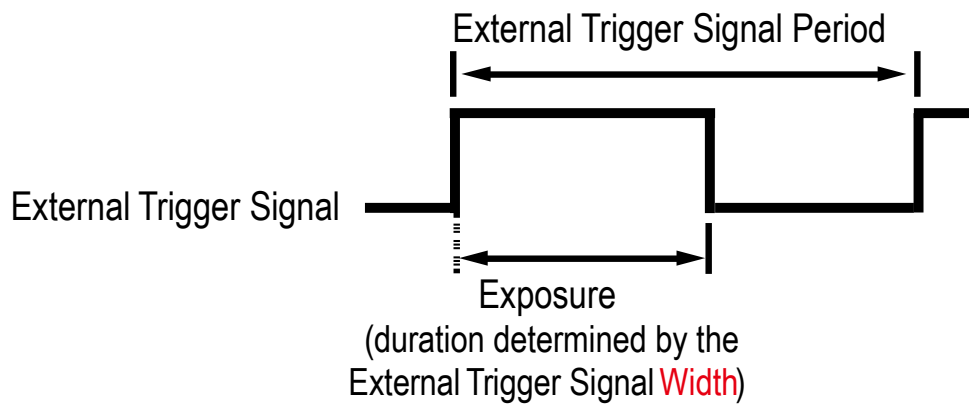

Figure 8-6 **Trigger Width Exposure Mode**

8.4 Setting the Exposure Time

This section describes how the exposure time can be adjusted manually by setting the value of the **Exposure Time** parameter. If you are operating the camera in any one of the following ways, you must specify an exposure time by setting the camera's **Exposure Time** parameter.

- the **Trigger Mode** is set to **Off**.
- the **Trigger Mode** is set to **On** and the **Trigger Source** is set to **Software**.
- the **Trigger Mode** is set to **On**, the **Trigger Source** is set to **User Output0**, **CC1**, **Timer0 Active** or **Line0**, and the **Exposure Mode** is set to **Timed**.

The **Exposure Time** parameter must not be set below a minimum specified value. The **Exposure Time** parameter sets the exposure time in microseconds (μs). The minimum and maximum exposure time settings for the VC-61MC 13H camera are shown in the following table.

Camera Link Tap	Minimum Exposure Time	Maximum Exposure Time †
2 Tap	112.77 μs	60,000,000 μs
4 Tap	56.47 μs	60,000,000 μs
8 Tap	28.33 μs	60,000,000 μs
10 Tap	22.72 μs	60,000,000 μs

†: When the **Exposure Mode** is set to **Trigger Width**, the exposure time is controlled by the external trigger signal and has no maximum limit.

Table 8-1 Minimum and Maximum Exposure Time Setting

8.5 Rolling Shutter

The VC-61MC 13H camera is equipped with an image sensor that has an electronic rolling shutter. The camera exposes and reads out the pixel line with a temporal offset (t_{Row}) from one line to the next. When a trigger signal is applied to the camera, the camera resets the top line of pixels (Line 1) and begins exposing that line. The camera resets line two t_{Row} later and begins exposing the line. And so on until the bottom line of pixels (Line N) is reached. The pixel values for each line are read out at the end of exposure for the line. The readout time for each line is identical to the t_{Row} value.

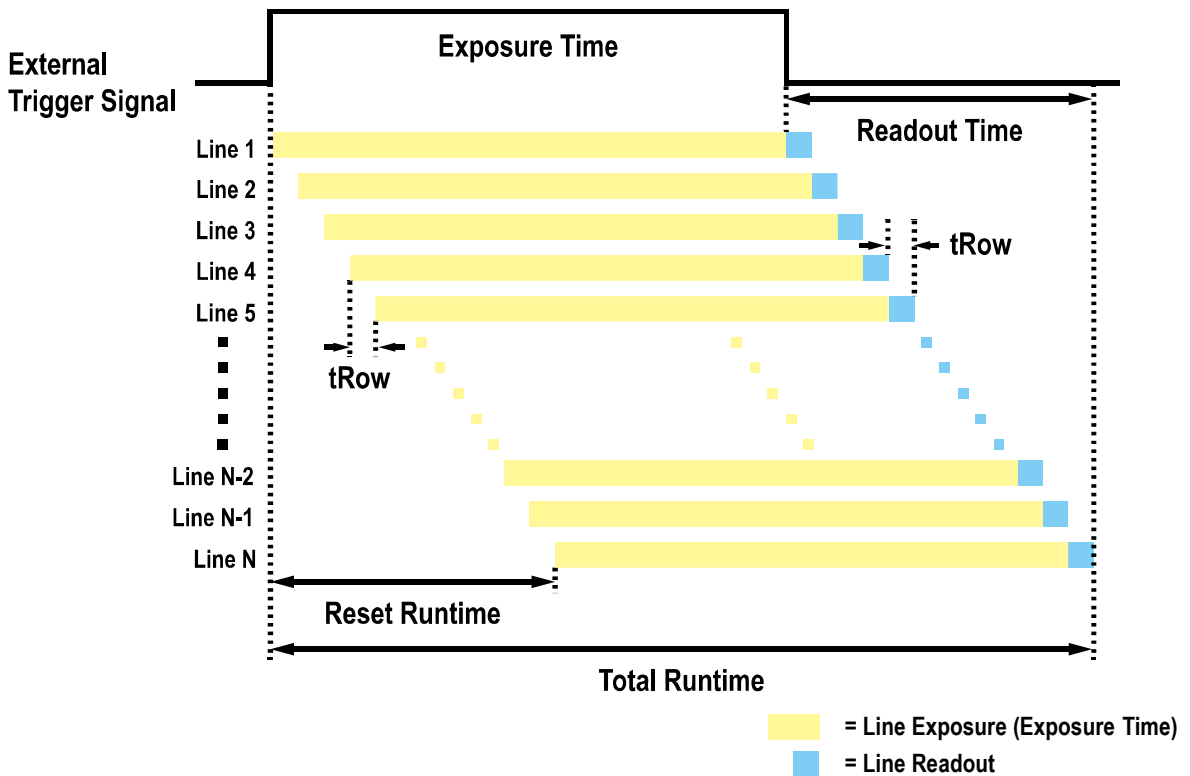

Figure 8-7 Rolling Shutter Operation

The tRow values depending on the VC-61MC-13 H camera's Camera Link Tap Geometry settings are as follows:

Camera Link Tap Geometry	tRow
2 Tap	8.66 μ s
4 Tap	8.66 μ s
8 Tap	8.66 μ s
10 Tap	8.66 μ s

Table 8-2 Temporal Offset Values depending on the Camera Link Tap Geometry



Note:

The temporal offset values shown in the table above refer to camera operation at full resolution. These values vary when you use the binning feature or change the Image ROI settings.

8.6 Overlapping Exposure with Sensor Readout

The frame acquisition process on the camera includes two distinct parts. The first part is the exposure of the pixels in the image sensor. Once exposure is complete, the second part of the process – readout of the pixel values from the sensor – takes place. In regard to this frame acquisition process, the VC-61MC 13H camera can be operated in the Overlapped acquisition mode or the Non-overlapped acquisition mode.

8.6.1 Overlapped Acquisition with Trigger Mode = Off

When the Trigger Mode parameter is set to Off (Free-run mode), the camera operates with ‘overlapped’ acquisition so that the exposure for a new frame can be overlapped with the sensor readout for the previous frame. The exposure of a new frame begins while the camera is still reading out the sensor data for the previously acquired frame.

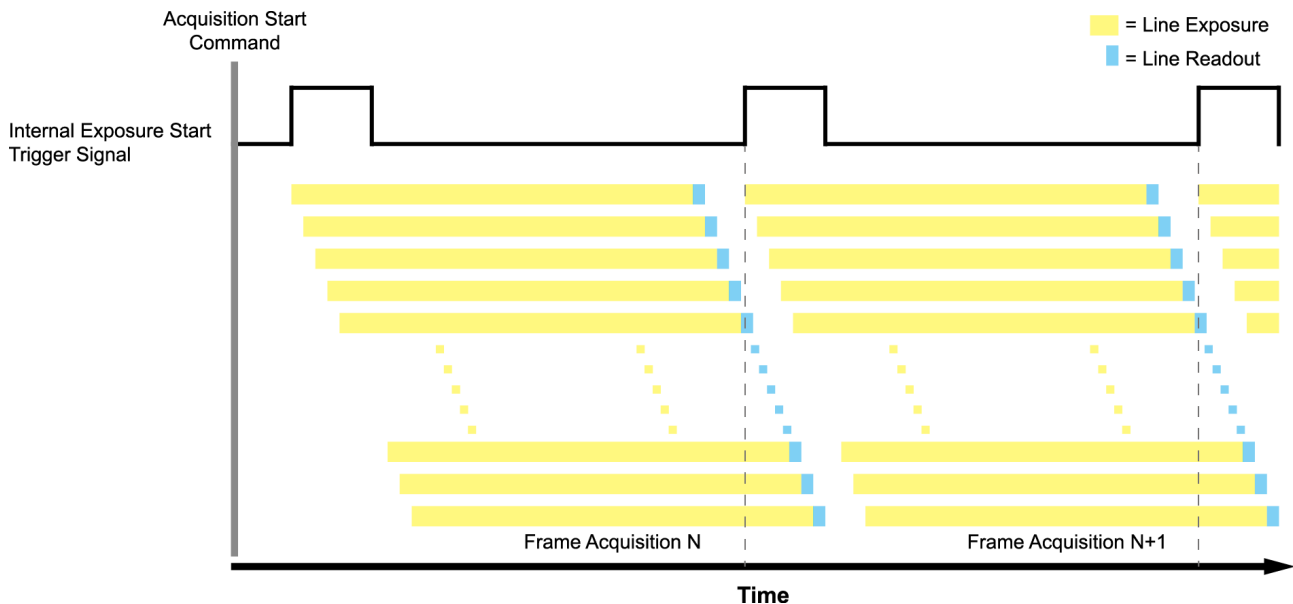

Figure 8-8 Overlapped Exposure and Readout

Determining whether your camera is operating with overlapped exposure and readout is not a matter of issuing a command or changing a setting. Rather a way that you operate the camera will determine whether the exposures and readouts are overlapped or not. If we define the “Frame Period” as the time from the start of exposure for frame acquisition N to the start of exposure for frame acquisition N+1, then:

- Non-overlap: Frame Period > Exposure Time + Readout Time
- Overlap: Frame Period ≤ Exposure Time + Readout Time

8.6.2 Non-overlapped Acquisition with Trigger Mode = On

When the **Trigger Mode** parameter is set to **On**, each time a frame is acquired the camera basically completes the entire exposure/readout process before acquisition of the next frame is started. The exposure for a new frame does not overlap the sensor readout for the previous frame. The following figure illustrates the **Trigger Mode** parameter set to **On**, the **Trigger Source** parameter set to **Line0**, and the **Exposure Mode** parameter set to **Trigger Width**.

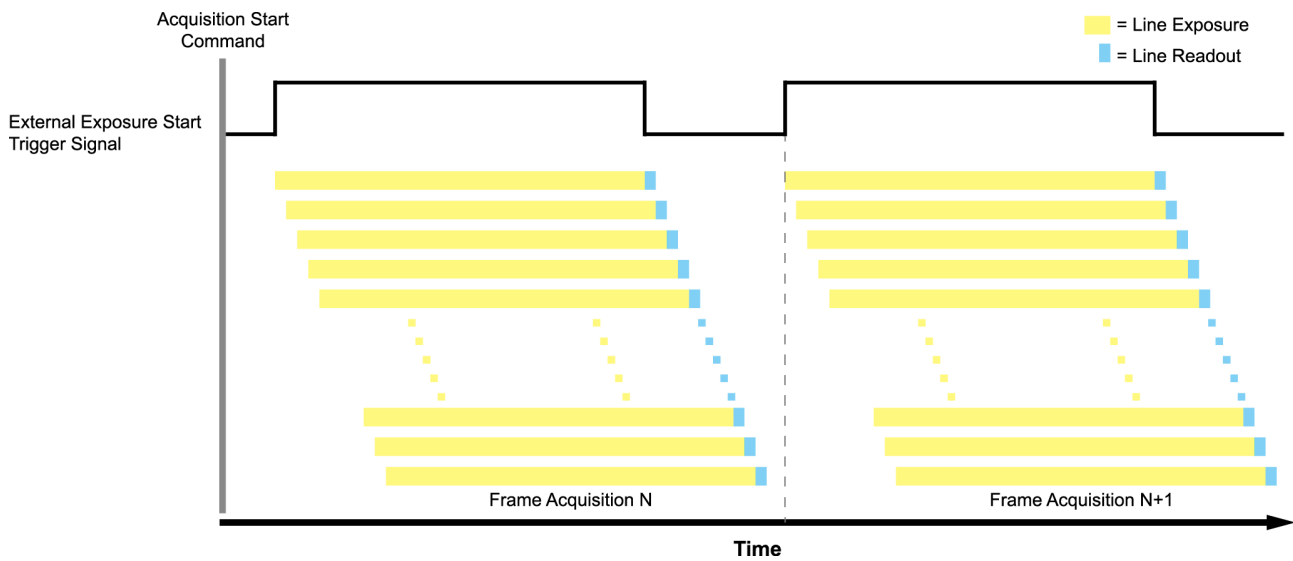

Figure 8-9 Non-overlapped Exposure and Readout

When you set the **Trigger Mode** parameter to **On** and operate the camera under the following condition, the camera can acquire images at the maximum frame rate.

$$\frac{1}{\text{Highest Possible Frame Rate}} \geq \text{Maximum Allowed Exposure Time for Non-overlapped Operation} + \text{Total Readout Time}$$

For example, if you want to acquire images at the maximum frame rate (5.5 fps) using the VC-61MC 13H camera with the Camera Link Tap Geometry - 4 Tap setting, you must set the exposure time to a value less than 126,567 μs .

$$\text{Maximum Allowed Exposure Time for Non-overlapped Operation} \leq \frac{1}{5.5 \text{ fps}} - (6380 \times 8.66 \mu\text{s}) = 126,567 \mu\text{s}$$

When you want to acquire images at the maximum frame rate with the **Trigger Mode** parameter set to **On**, you must set the camera's exposure time to a value less than the maximum allowed exposure time for 'non-overlapped' operation. The maximum allowed exposure time to acquire images at the maximum frame rate in the 'non-overlapped' operation is shown below.

Camera Link Tap Geometry	Highest Possible Frame Rate	Max. Exposure Time
2 Tap	2.75 fps	308,385 μs
4 Tap	5.50 fps	126,567 μs
8 Tap	10.97 fps	35,906 μs
10 Tap	13.68 fps	17,848 μs

Table 8-3 Max. Allowed Exposure Time and Frame Rate for Non-overlapped Operation

8.7 Maximum Allowed Frame Rate

In general, the maximum allowed acquisition frame rate on the camera may be limited by several factors:

- The amount of time that it takes to transmit an acquired frame from the camera to your computer. The amount of time needed to transmit a frame depends on the bandwidth assigned to the camera.
- The amount of time it takes to read an acquired frame out of the image sensor and into the camera's frame buffer. This time varies depending on the setting for ROI. Frames with a smaller height and/or width take less time to read out of the sensor. The frame height and width are determined by the camera's **Height** and **Width** settings in the **Image Format Control** category.
- Camera Link Tap Configuration (Tap Mode) Settings
When the camera is set for a Tap Mode that uses more taps, it will take less time to transfer acquired images from the camera to the Camera Link frame grabber in your computer. For example, if the camera is set to 8 Tap (Camera Link Full Configuration), it can typically transfer data out of the camera two times faster than when the camera is set to 4 Tap (Camera Link Medium).
- The exposure time for acquired frames. If you use very long exposure time, you can acquire fewer frames per second.

8.7.1 Increasing the Maximum Allowed Frame Rate

You may find that you would like to acquire frames at a rate higher than the maximum allowed with the camera's current settings. In this case, you must adjust one or more of the factors that can influence the maximum allowed frame rate and then check to see if the maximum allowed frame rate has increased.

- The time that it takes to transmit a frame out of the camera is the main limiting factor on the frame rate. You can decrease the frame transmission time (and thus increase the maximum allowed frame rate) by using the ROI feature. Decreasing the size of the Image ROI may increase the maximum allowed frame rate. If possible, decrease the height and/or width of the Image ROI.
- If you are using a Device Tap Geometry with a low number of taps, consider using a Device Tap Geometry with a high number of taps. This will usually increase the maximum allowed frame rate.
- If you are using normal exposure times and you are using the camera at its maximum resolution, your exposure time will not normally restrict the frame rate. However, if you are using long exposure time, it is possible that your exposure time is limiting the maximum allowed frame rate. If you are using a long exposure time, try using a shorter exposure time and see if the maximum allowed frame rate increases (You may need to compensate for a lower exposure time by using a brighter light source or increasing the opening of your lens aperture.).

**Note:**

A very long exposure time severely limits the camera's maximum allowed frame rate. As an example, assume that your camera is set to use a 1 second exposure time. In this case, because each frame acquisition will take at least 1 second to be completed, the camera will only be able to acquire a maximum of one frame per second.

Chapter 9. Camera Features

9.1 Region of Interest

The Image Region of Interest (ROI) feature allows you to specify a portion of the sensor array. You can acquire only the frame data from the specified portion of the sensor array while preserving the same quality as you acquire a frame from the entire sensor array.

With the ROI feature, you can increase the maximum allowed frame rate by decreasing the **Width** and/or **Height** parameters. The ROI is referenced to the top left corner [origin (0, 0)] of the sensor array as shown below.

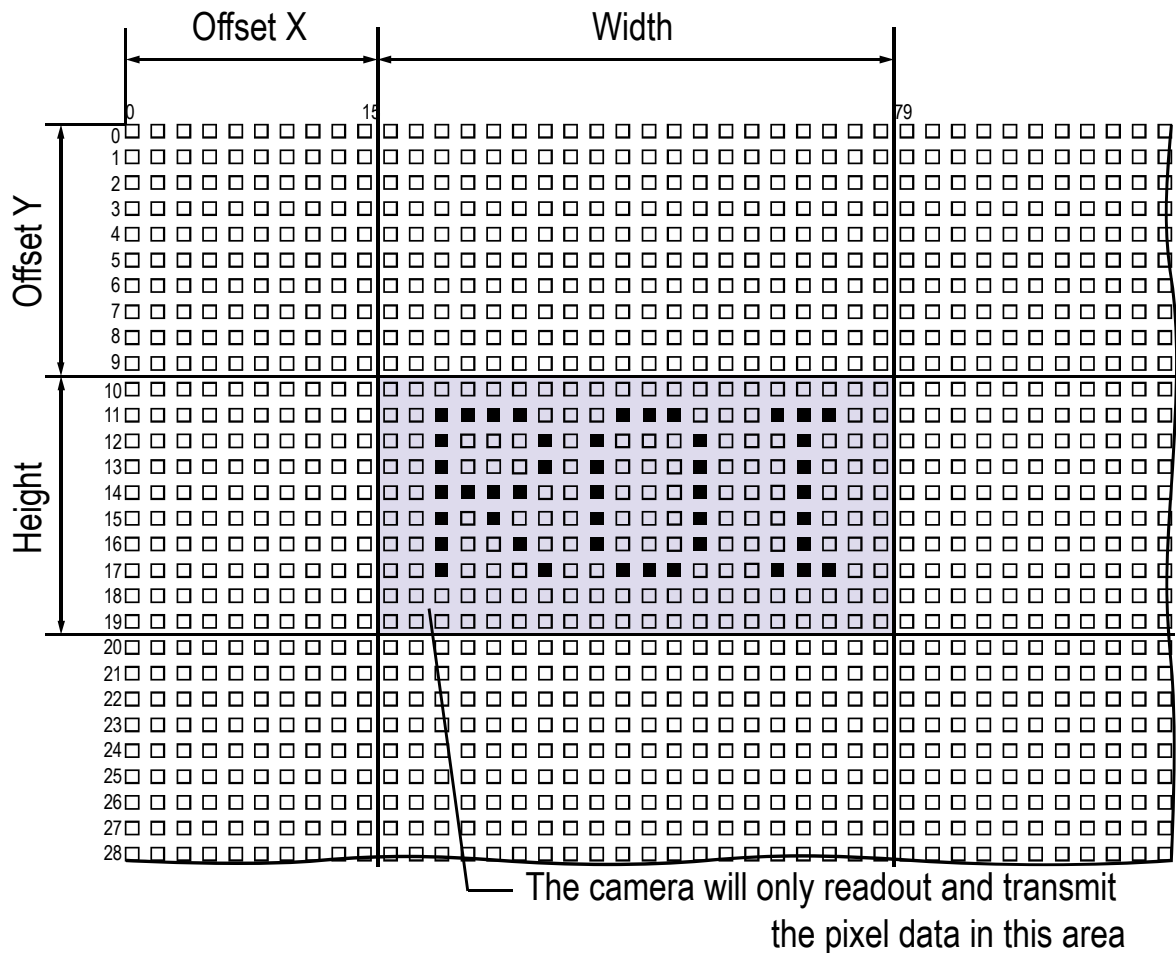

Figure 9-1 Region of Interest

The XML parameters related to ROI settings are as follows.

XML Parameters	Value	Description	
ImageFormatControl	SensorWidth ^a	-	Effective width of the sensor
	SensorHeight ^a	-	Effective height of the sensor
	WidthMax ^a	-	Maximum allowed width of the image with the current camera settings
	HeightMax ^a	-	Maximum allowed height of the image with the current camera settings
	Width ^b	-	Sets the Width of the Image ROI.
	Height ^b	-	Sets the Height of the Image ROI.
	OffsetX ^c	-	Sets the horizontal offset from the origin to the Image ROI.
	OffsetY ^c	-	Sets the vertical offset from the origin to the Image ROI.

The unit for all parameters in this table is pixel.

a: Read only. User cannot change the value.

b: User configurable parameters for setting ROI

c: User configurable parameters for setting the origin of the ROI

Table 9-1 XML Parameters related to ROI

You can change the size of ROI by setting the **Width** and **Height** parameters in the **Image Format Control** category. You can also change the position of the ROI origin by setting the **Offset X** and **Offset Y** parameters. Make sure that the **Width + Offset X** value is less than the **Width Max** value, and the **Height + Offset Y** value is less than the **Height Max** value. You must set the size of the ROI first, and then set the Offset values since the **Width** and **Height** parameters are set to its maximum value by default.

- On the VC-61MC 13H camera, the **Width** parameter must be set to a multiple of 16, and the **Height** parameter must be set to a multiple of 4.

The minimum allowed setting values for the ROI Width and Height are shown below.

Camera Model	Minimum Width Settings	Minimum Height Settings
VC-61MC 13H	64	4

Table 9-2 Minimum ROI Width and Height Settings

On the VC-61MC 13H camera, the maximum allowed frame rates depending on Horizontal and Vertical ROI changes are shown below. The maximum allowed frame rates shown below are based on 8 bit Pixel Format and on 85 MHz of the Camera Link Pixel Clock.

ROI Size (H × V)	2 Tap	4 Tap	8 Tap	10 Tap
9568 × 4	316.6 fps	632.1 fps	1259.4 fps	1569.8 fps
9568 × 1000	16.8 fps	33.6 fps	67.0 fps	83.6 fps
9568 × 2000	8.6 fps	17.2 fps	34.3 fps	42.8 fps
9568 × 3000	5.8 fps	11.6 fps	23.1 fps	28.8 fps
9568 × 4000	4.3 fps	8.7 fps	17.4 fps	21.7 fps
9568 × 5000	3.5 fps	7.0 fps	13.9 fps	17.4 fps
9568 × 6380	2.7 fps	5.5 fps	10.9 fps	13.6 fps

Table 9-3 Maximum Frame Rates by the Vertical ROI Changes



Caution!

Your Frame Grabber may place additional restrictions on how the ROI location and size must be set. Refer to your Frame Grabber user manual for more information.

9.2 Binning (Monochrome Only)

The Binning has the effects of increasing the level value and decreasing resolution by summing the values of the adjacent pixels and sending them as one pixel. The XML parameters related to Binning are as follows.

XML Parameters	Value	Description
ImageFormat BinningSelector Control	Sensor	Selects the Sensor for the binning engine. Applies the Binning in analog by the image sensor.
	Logic	Selects the Logic for the binning engine. Applies the Binning in digital by the logic.
BinningHorizontal Mode	Sum	According to the Binning Selector setting: <ul style="list-style-type: none"> • Sensor: N/A • Logic: Adds pixel values of the adjacent pixels as specified in the Binning Horizontal, and then sends them as one pixel.
	Average	According to the Binning Selector setting: <ul style="list-style-type: none"> • Sensor: Updated automatically according to the Binning Vertical Mode. • Logic: Averages pixel values of the adjacent pixels as specified in the Binning Horizontal, and then sends them as one pixel.
BinningHorizontal	×1, ×2, ×3, ×4	According to the Binning Selector setting: <ul style="list-style-type: none"> • Sensor: Updated automatically according to Binning Vertical (×1, ×2, ×3). • Logic: The number of horizontal pixels to combine together (×1, ×2, ×4).
BinningVertical Mode	Sum	According to the Binning Selector setting: <ul style="list-style-type: none"> • Sensor: N/A • Logic: Adds pixel values of the adjacent pixels as specified in the Binning Vertical, and then sends them as one pixel.
	Average	Averages pixel values of the adjacent pixels as specified in the Binning Vertical, and then sends them as one pixel.
BinningVertical	×1, ×2, ×3, ×4	The number of vertical pixels to combine together: <ul style="list-style-type: none"> • Sensor: ×1, ×2, ×3 • Logic: ×1, ×2, ×4

Table 9-4 XML Parameters related to Binning

Caution!



- When the Binning Selector is set to Sensor, the Average Binning is only available.
- When the Binning Selector is set to Sensor, ×1, ×2 or ×3 is only available.
- When the Binning Selector is set to Logic, ×1, ×2 or ×4 is only available.
- The binning feature is available with XML parameters and serial commands, but not supported in Configurator.

For example, if you set the **Binning Selector** to **Logic** and set 2×2 binning, the camera's resolution is reduced to $1/4$. If you set the **Binning Horizontal/Vertical Mode** to **Sum**, the maximum allowed resolution of the image is reduced to $1/2$ and the responsivity of the camera is quadrupled. If you set the **Binning Horizontal/Vertical Mode** to **Average**, the maximum allowed resolution of the image is reduced to $1/2$, but there is no difference in responsivity between a binned image and an original image.

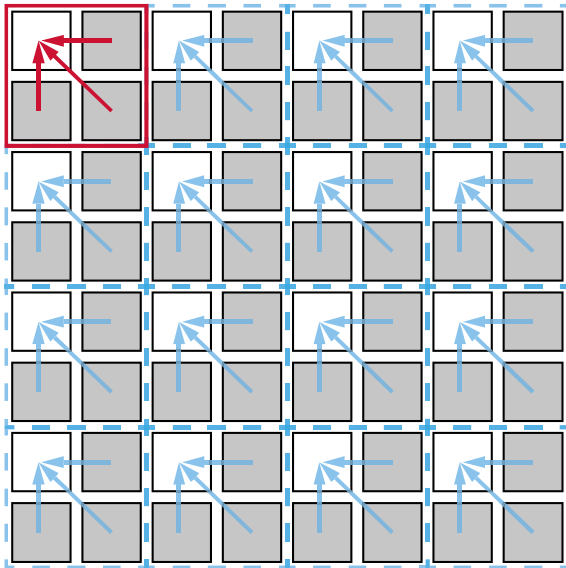

Figure 9-2 2×2 Binning

You can also use both the Sensor and Logic binning engines simultaneously. For example, you can set the **Binning Selector** to **Sensor**, **Binning Horizontal/Vertical Mode** to **Average**, and the **Binning Vertical** to $\times 3$. Then, you can set the **Binning Selector** to **Logic**, **Binning Horizontal/Vertical Mode** to **Average**, and the **Binning Horizontal/Vertical** to $\times 4$. With these settings, you can implement 12×12 binning.

9.3 Pixel Format

The VC-61MC 13H camera processes image data in the unit of 12 bit. The pixel format of the image data is available to be chosen among 8 bit, 10 bit, or 12 bit with the **Pixel Format** parameter. For instance, the 2 least significant bits will be dropped from overall 10 bits when the camera is set for 10-bit pixel format.

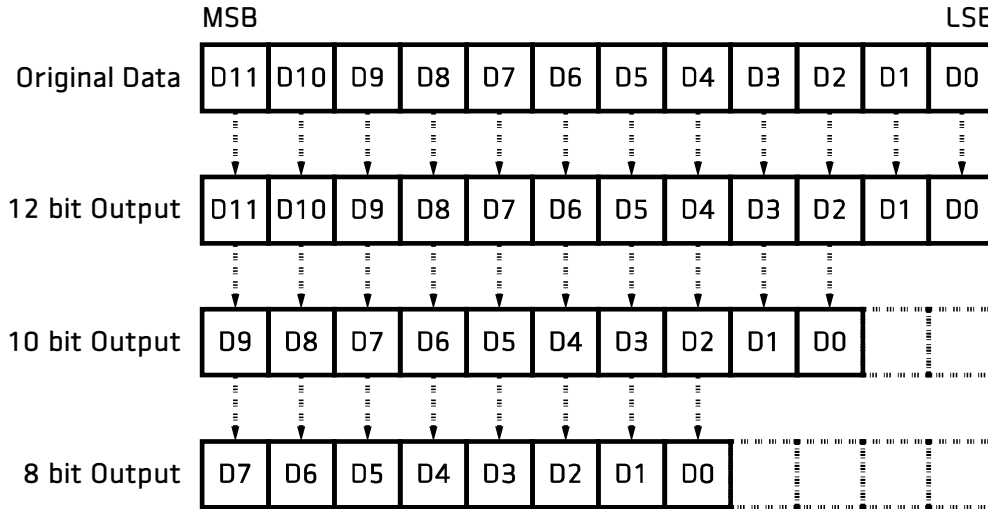

Figure 9-3 VC-61MC 13H Pixel Format

The XML parameter related to Pixel Format is as follows.

XML Parameter		Description
ImageFormatControl	PixelFormat	Sets the pixel format supported by the device

Table 9-5 XML Parameter related to Pixel Format

The available pixel formats on the monochrome and color cameras are as follows.

Mono Sensor	Color Sensor
Mono 8	Mono 8
Mono 10	Mono 10
Mono 12	Mono 12
	Bayer GB 8
	Bayer GB 10
	Bayer GB 12

Table 9-6 Pixel Format Values

9.4 Device Tap Geometry

The VC-61MC 13H camera supports 2 Tap, 4 Tap, 8 Tap and 10 Tap Device Tap Geometry. The number of taps represents the number of pixel data that will be output on each cycle of the Camera Link Pixel Clock. The maximum allowed frame rate will be changed according to the Device Tap Geometry settings. The image data is transmitted in the interleaved order as shown in the figure below.

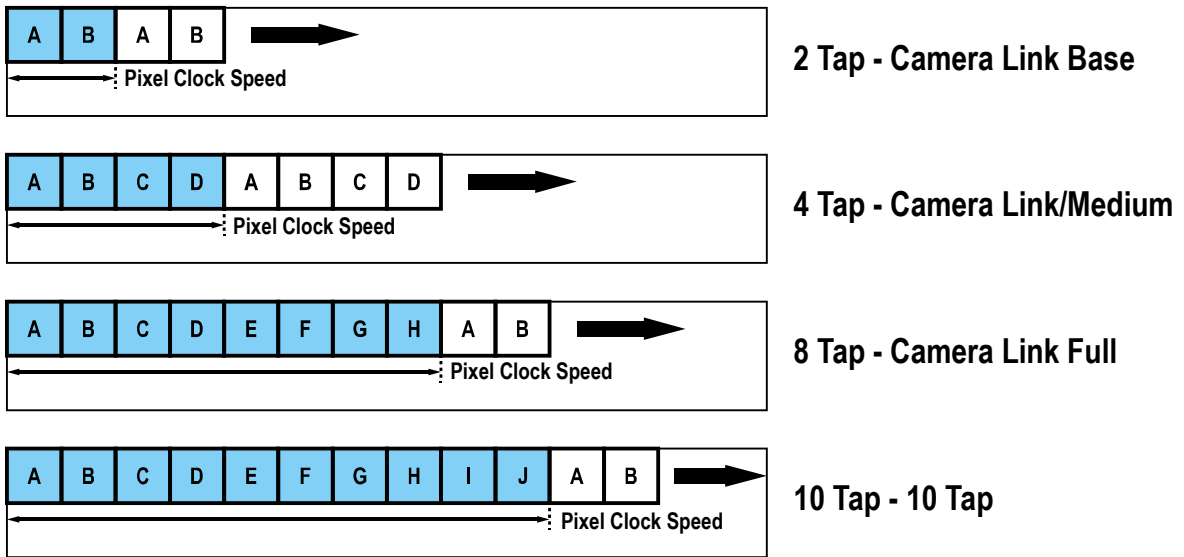

Figure 9-4 Device Tap Geometry

The XML parameter related to Device Tap Geometry is as follows.

XML Parameters	Value	Description
TransportLayer Control	DeviceTapGeometry Geometry_1X2_1Y	Sets the Device Tap Geometry to 2 Tap
	Geometry_1X4_1Y	Sets the Device Tap Geometry to 4 Tap
	Geometry_1X8_1Y	Sets the Device Tap Geometry to 8 Tap
	Geometry_1X10_1Y	Sets the Device Tap Geometry to 10 Tap

Table 9-7 XML Parameter related to Device Tap Geometry

9.5 Camera Link Clock

The VC-61MC 13H camera provides selectable Camera Link Pixel Clock speeds. The Pixel Clock speed determines that the rate at which pixel data will be transmitted from the camera to the frame grabber in your computer via the Camera Link interface. Setting the camera for a higher Pixel Clock speed will increase the rate at which image data is transferred from the camera to the frame grabber. Before setting the camera's Pixel Clock speed, make sure you determine the maximum Pixel Clock speed supported by your frame grabber. Then, you should not attempt to set the camera's Pixel Clock speed that exceeds the maximum Pixel Clock speed for your frame grabber.

The XML parameters related to Camera Link Pixel Clock speed is as follows.

XML Parameters		Value	Description
CameraLink	CameraLinkClock	Clock0	Sets the Camera Link Clock speed to 85 Mhz.
		Clock1	Sets the Camera Link Clock speed to 65 Mhz.
	CameraLinkClockFrequency	-	Displays the current Camera Link Clock speed in Mhz.

Table 9-8 XML Parameters related to Camera Link Clock Speed

9.6 Data ROI (Color Camera)

The Balance White Auto feature provided by the color camera uses the pixel data from a Data Region of Interest (ROI) to adjust the related parameters. The XML parameters related to Data ROI are as follows.

XML Parameters	Value	Description
DataRoiControl	RoiSelector	WhiteBalanceAuto
	RoiOffsetX	-
	RoiOffsetY	-
	RoiWidth	-
	RoiHeight	-

Table 9-9 XML Parameters related to Data ROI

Only the pixel data from the area of overlap between the Data ROI and the Image ROI by your settings will be effective if you use the Image ROI and Data ROI at the same time. The effective ROI is determined as shown in the figure below.

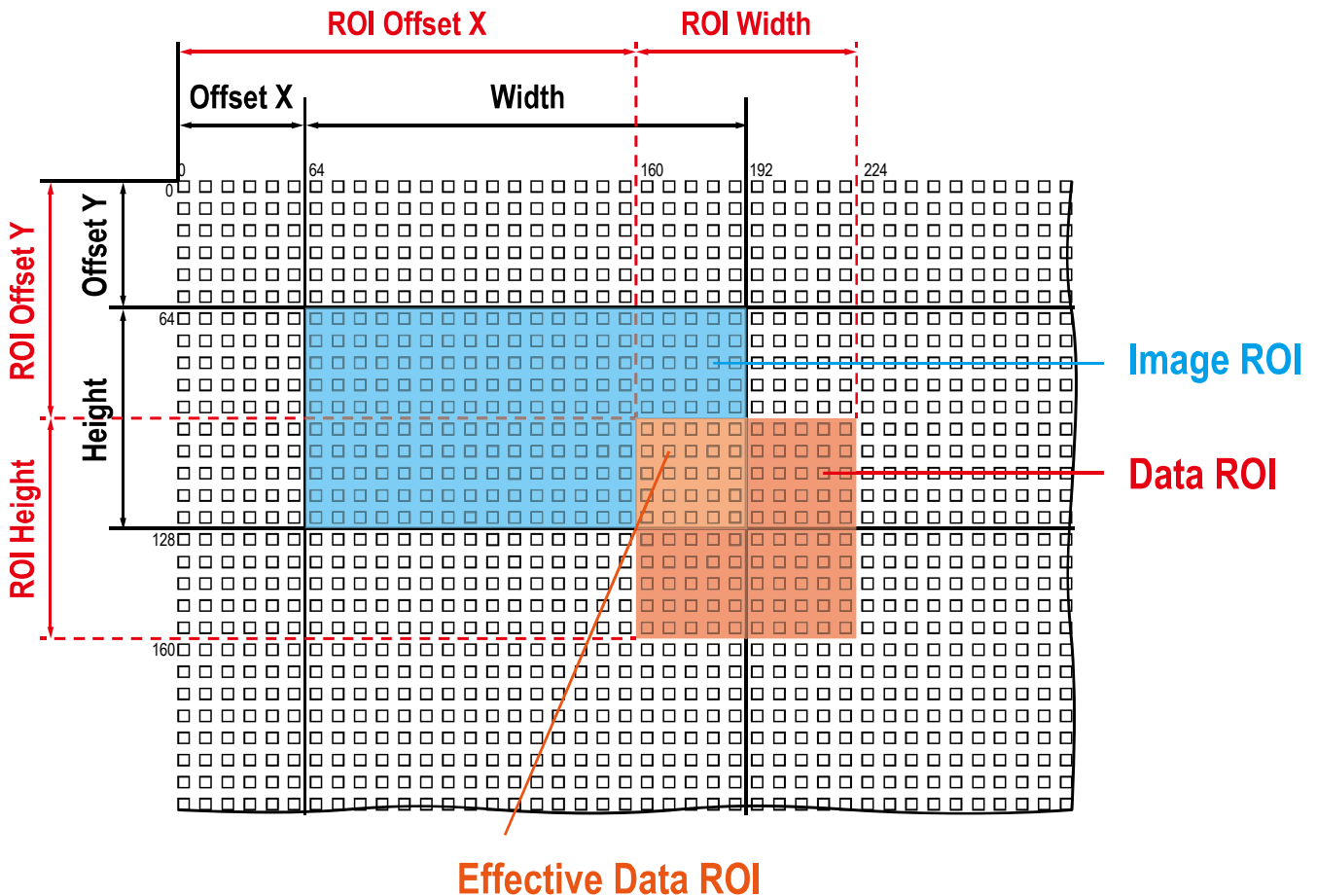

Figure 9-5 Effective Data ROI

9.7 White Balance (Color Camera)

The color camera includes the white balance capability to adjust the color balance of the images transmitted from the camera. With the white balancing scheme used on the VC-25MC-31 I camera, the Red, Green and Blue intensities can be adjusted individually. You can set the intensity of each color by using the **Balance Ratio** parameter. The Balance Ratio value can range from 1.0 to 4.0. If the **Balance Ratio** parameter is set to 1.0 for a color, the intensity of the color will be unaffected by the white balance mechanism. If the **Balance Ratio** parameter is set to greater than 1.0, the intensity of the color will be proportionally increased to the ratio. For example, if the **Balance Ratio** is set to 1.5, the intensity of that color will be increased by 50%.

The XML parameters related to White Balance are as follows.

XML Parameters		Value	Description
AnalogControl	BalanceRatio Selector	Red	A Balance Ratio value will be applied to red pixels.
		Green	A Balance Ratio value will be applied to green pixels.
		Blue	A Balance Ratio value will be applied to blue pixels.
	BalanceRatio	×1.0 ~ ×4.0	Adjusts the ratio of the selected color.

Table 9-10 XML Parameters related to White Balance

9.7.1 Balance White Auto

The Balance White Auto feature is implemented on the color camera. It will control the white balance of the image acquired from the color camera according to the GreyWorld algorithm. Before using the Balance White Auto feature, you need to set the Data ROI for Balance White Auto. If you do not set the related Data ROI, the pixel data from the Image ROI will be used to control the white balance. As soon as the **Balance White Auto** parameter is set to **Once**, the Balance Ratio values for Red and Blue will be automatically adjusted to adjust the white balance by referring to Green.

The XML parameters related to Balance White Auto are as follows.

XML Parameter		Value	Description
AnalogControl	BalanceWhite Auto	Off	Balance White Auto Off
		Once	White Balance is adjusted once and then Off.

Table 9-11 XML Parameter related to Balance White Auto

9.8 Gain and Black Level

Increasing the **Gain** parameter increases all pixel values of the image. This results in a higher grey value output from the camera for a given amount of output from the image sensor.

1. Selects the Gain Control to be adjusted by using the **Gain Selector** parameter.
2. Sets the **Gain** parameter to the desired value.

Adjusting the **Black Level** parameter will result in an offset to the pixel values output from the camera.

3. Selects the Black Level Control to be adjusted by using the **Black Level Selector** parameter.
4. Sets the **Black Level** parameter to the desired value. The available setting range varies depending on the **Pixel Format** settings.

The XML parameters related to Gain and Black Level are as follows.

XML Parameters		Value	Description
Analog Control	GainSelector	Analog All	Applies the Gain value to all analog channels.
		Digital All	Applies the Gain value to all digital channels.
	Gain	1.0× – 32.0×	Sets a digital gain value.
	BlackLevel Selector	Digital All	Applies the Black Level value to all digital channels.
BlackLevel	8 bit: 0 ~ 15.93 10 bit: 0 ~ 63.75 12 bit: 0 ~ 255.00	Sets a black level value	

Table 9-12 XML Parameters related to Gain and Black Level

9.9 Hot Pixel Correction

When you acquire images with long exposure times or operate the camera under the condition of high ambient temperature, hot pixels may be appeared on the images due to the characteristics of the high-resolution CMOS image sensor. The VC-61MC 13H camera provides the Hot Pixel Correction feature to remove hot pixels.

The XML parameter related to Hot Pixel Correction is as follows.

XML Parameter		Value	Description
DSNUControl	HotPixelCorrection	Off	Disables the Hot Pixel Correction feature.
		On	Enables the Hot Pixel Correction feature.

Table 9-13 XML Parameter related to Hot Pixel Correction

9.10 Defective Pixel Correction

The CMOS sensor may have defect pixels which cannot properly react to the light. Correction is required since it may deteriorate the quality of output image. Defect pixel information of CMOS used for each camera is entered into the camera during the manufacturing process. If you want to add defect pixel information, it is required to enter coordinate of new defect pixel into the camera. For more information, refer to Appendix A.

9.10.1 Correction Method

A correction value for a defect pixel is calculated based on the valid pixel value adjacent in the same line.

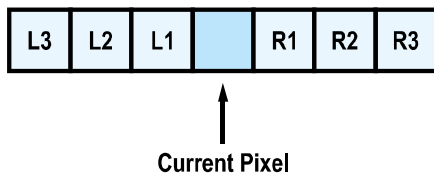

Figure 9-6 Location of Defect Pixel to be corrected

If the Current Pixel is a defect pixel as shown in the figure above, the correction value for this pixel is obtained as shown in the following table depending on whether surrounding pixels are defect pixels or not.

Adjacent Defect Pixel	Correction Value of Current Pixel
None	$(L1 + R1) / 2$
L1	R1
R1	L1
L1, R1	$(L2 + R2) / 2$
L1, R1, R2	L2
L2, L1, R1	R2
L2, L1, R1, R2	$(L3 + R3) / 2$
L2, L1, R1, R2, R3	L3
L3, L2, L1, R1, R2	R3

Table 9-14 Calculation of Defect Pixel Correction Value

9.11 Photo Response Non-uniformity Correction

In theory, when a digital camera acquires images with the camera viewing a uniform light-colored target in bright light, all of the pixel values in the image should be near the maximum grey value and they should be equal.

In practice, however, slight variations in the performance of the pixels in the sensor, variations in the optics, and variations in the lighting will cause some variations in the pixel values output from the camera. This variation is known as Photo Response Non-Uniformity (PRNU). The VC-61MC 13H camera provides the PRNU correction feature. The PRNU Correction feature applied in the VC-61MC 13H camera acquires one or more images under the unsaturated lighting condition and then obtains the average grey level value of the entire image. Then, PRNU coefficients for each pixel will be generated according to the average grey level value. These correction values will be generated and applied to the VC-61MC 13H camera during the manufacturing process.

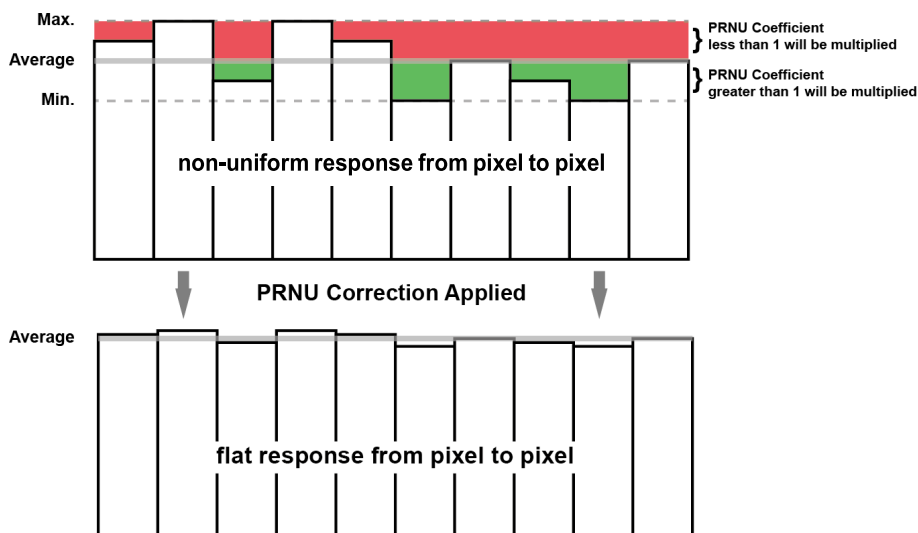

Figure 9-7 PRNU Correction

9.12 Flat Field Correction

The Flat Field Correction feature improves the image uniformity when you acquire a non-uniformity image due to external conditions. The Flat Field Correction feature of the VC-61MC 13H camera can be summarized by the following equation.

$$IC = (IR \times M) / IF$$

IC: Level value of corrected image

IR: Level value of original image

M: Target value of image after correction

IF: Level value of Flat Field data

In actual use conditions, generate a Flat Field correction data and then save the data into the non-volatile memory of the camera by following the procedure below.

1. Select Auto or User Set by using the Flat Field Target Selector parameter.
 - Auto: The camera automatically adjusts the target value of the image after correction.
 - User Set: Allows you to set the user-defined target value of the image by using the Flat Field Target Level parameter.

2. Execute the Flat Field Data Generate parameter.

After executing the Flat Field Data Generate parameter, you must acquire one image to generate the scaled-down Flat Field correction data.

3. Use the Flat Field Data Selector parameter to specify a location to save the generated Flat Field correction data.

4. Execute the Flat Field Data Save parameter to save the generated Flat Field correction data into the non-volatile memory. The scaled-down Flat Field correction data will be expanded and then applied as shown in the Figure 9-9 when it is used for correction.

To disregard the generated Flat Field correction data and use the previous Flat Field correction data, execute the Flat Field Data Load parameter without executing the Flat Field Data Save parameter.

5. Set the Flat Field Correction parameter to On to apply the Flat Field correction data to the camera.

**Caution!**

- It is recommended that you enable the **Defective Pixel Correction** feature before executing the **Flat Field Data Generate** parameter.
- Before executing the **Flat Field Data Generate** parameter, you must set the camera as follows:
OffsetX, Y: 0
Width, Height: Maximum values
- After executing the **Acquisition Start** command, you need to operate the camera with the free-run mode or apply a trigger signal to acquire an image.
- To set the Flat Field Target Level manually, use the XML parameters or serial commands. The Configurator does not support setting the user-defined Flat Field Target Level.

**FFC for the color camera**

When you set the **Pixel Format** parameter to a Bayer pattern (Bayer RG 8/10/12) and enable the Flat Field Correction feature on the color camera, the FFC will be performed for each color pixel (red, green1, green2 and blue) separately. This significantly removes image artifacts to improve pixel to pixel color uniformity.

The XML parameters related to Flat Field Correction are as follows.

XML Parameters	Value	Description	
FlatFieldControl	FlatFieldCorrection	Off	Disables the Flat Field Correction feature.
		On	Enables the Flat Field Correction feature.
FlatFieldData Selector	FlatFieldData Selector	Space0 - Space15	Selects a location to save Flat Field data to or load Flat Field data from.
	FlatFieldTargetSelector	FlatFieldTargetSelector	Auto
			User Set
FlatFieldTargetLevel	FlatFieldTargetLevel	8bit: 1-255 12bit: 1 – 4095	Sets the target value of the image after correction when Flat Field Target Selector is set to User Set. <ul style="list-style-type: none"> • The setting range is based on the 12-bit Pixel Format.
FlatFieldData Generate	FlatFieldData Generate	-	Generates the Flat Field data.
FlatFieldDataSave	FlatFieldDataSave	-	Saves the generated Flat Field correction data in the non-volatile memory. The data generated by executing the Flat Field Data Generate parameter are saved in the volatile memory so that the data are lost if the camera is reset or if power is turned off. To use the data after the camera is powered on or reset, save them in the non-volatile memory.
FlatFieldDataLoad	FlatFieldDataLoad	-	Loads the Flat Field data from the non-volatile memory into volatile memory.

Table 9-15 XML Parameters related to Flat Field Correction

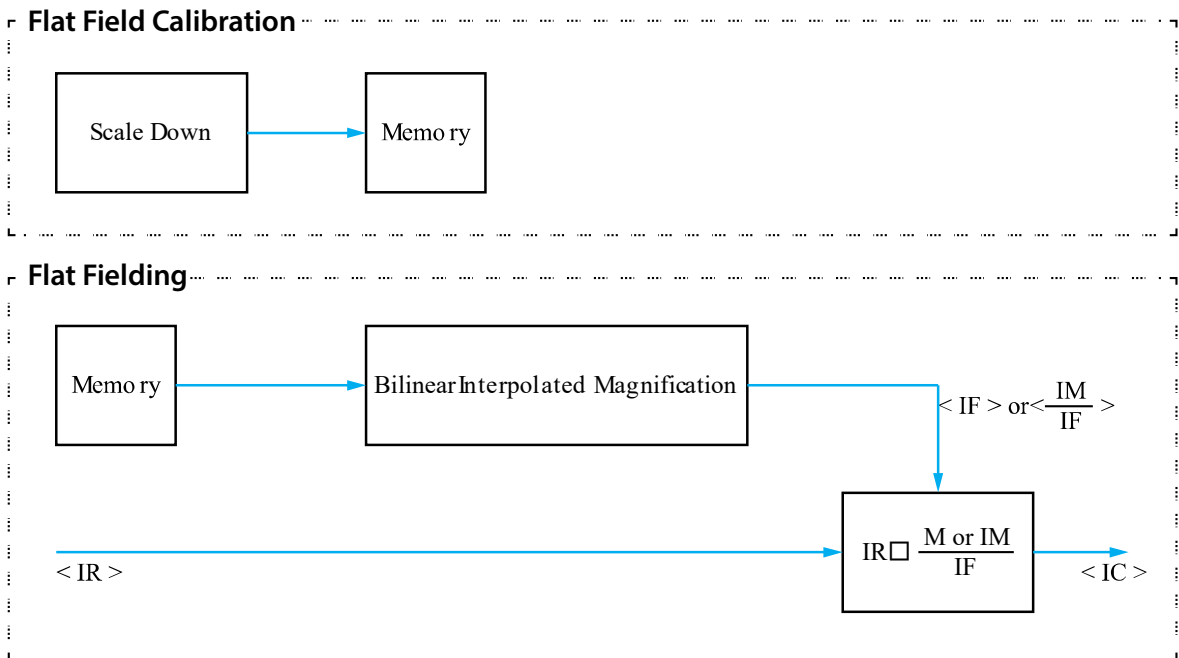

Figure 9-8 Generation and Application of Flat Field Data

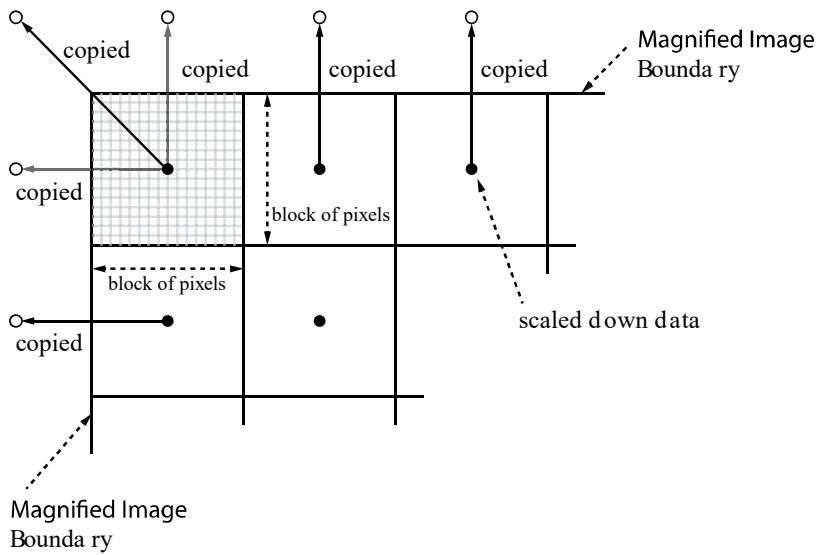

Figure 9-9 Bilinear Interpolated Magnification

9.12.1 Flat Field Data Selector

As mentioned above, the generated Flat Field correction data are stored in the camera's volatile memory and the data are lost if the camera is reset or powered off. To use the generated Flat Field correction data after the camera is powered on or reset, you need to save them in the camera's non-volatile memory. The VC-61MC 13H camera provides sixteen reserved locations in the camera's non-volatile memory available for saving and loading the Flat Field correction data. You can use the **Flat Field Data Selector** parameter to select a location as desired.

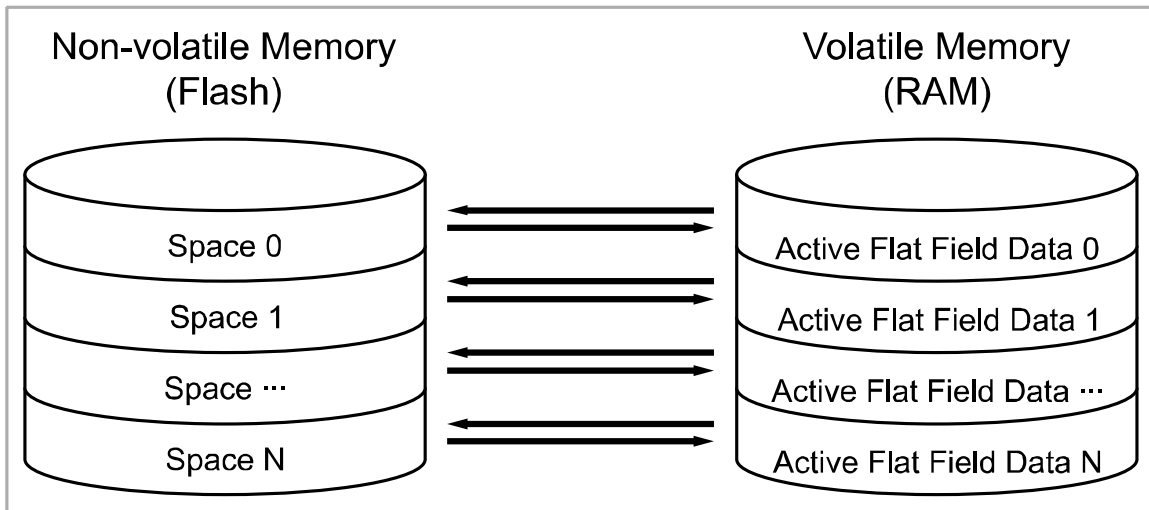

Figure 9-10 Flat Field Data Selector

Saving Flat Field Data

In order to save the active Flat Field data into a reserved location in the camera's Flash memory, follow the procedure below.

1. Use the **Flat Field Data Selector** parameter to specify a location to save the active Flat Field data.
2. Execute the **Flat Field Data Save** parameter to save the active Flat Field data to the selected location.

Loading Flat Field Data

If you saved Flat Field correction data into the camera's non-volatile memory, you could load the saved Flat Field correction data from the camera's non-volatile memory into the camera's active Flat Field data location.

1. Use the **Flat Field Data Selector** parameter to specify a reserved location whose Flat Field correction data will be loaded into the camera's active Flat Field data location.
2. Execute the **Flat Field Data Load** parameter to load the selected Flat Field correction data into the active Flat Field data location.

9.13 Sequencer Control

The Sequencer Control provided by the VC-61MC 13H camera allows you to apply different sets of parameter setting, called 'Sequencer Set', to a sequence of image acquisitions. As the camera acquires images, it applies one Sequencer Set after the other. This allows the camera to respond quickly to changing imaging requirements. For example, changes in illumination conditions influence the imaging requirements.

With the User Set Control feature, you can save user defined Sequencer Sets in the camera's non-volatile memory. Then after the camera is powered on or reset, the Sequencer Sets are available according to the **User Set Default** parameter. Each Sequencer Set is identified by an index number ranging from 0 to 31. Accordingly, you can define up to 32 different Sequencer Sets.

On the VC-61MC-13 H camera, only the Flat Field correction data can be configured for Sequencer Sets.

The XML parameters related to Sequencer Control are as follows.

Command	Value	Description	
SequencerControl	SequencerMode	Off	Disables the Sequencer.
		On	Enables the Sequencer.
SequencerConfiguration Mode		Off	Disables the Sequencer Configuration Mode.
		On	Enables the Sequencer Configuration Mode.
SequencerSetSelector	0 ~ 31	Selects an index number of a Sequencer Set to be configured.	
SequencerSetActive	-	Displays the index number (0 ~ 31) of the Sequencer Set that is currently active.	
SequencerSetCount	1 ~ 32	Sets the number of Sequencer Sets to be applied.	
ResetSequencer	-	Returns to Sequencer Set 0.	

Table 9-16 XML Parameters related to Sequencer Control



Caution!

To apply Sequencer Sets, you must first set the **Trigger Mode** parameter to **On**.

Use Case – Applying Four Different Flat Field Correction Data to Sequencer Sets

For example, assume that four different Flat Field correction data optimized for White, Green, Red and Blue pixels are applied to four different Sequencer Sets to inspect LCD panels.

1. Set the **Sequencer Mode** parameter to **Off**.
2. Set the **Sequencer Configuration Mode** parameter to **On**.
3. Set the **Sequencer Set Selector** parameter to **0** and set the **Flat Field Data Selector** parameter to **0**. Then, set the **Sequencer Set Selector** parameter to **1**, **2** and **3**, and then set the **Flat Field Data Selector** parameter to **1**, **2** and **3** respectively.
4. Set the **Sequencer Set Count** parameter to **4**.
5. Set the **Sequencer Configuration Mode** parameter to **Off**, and then set the **Sequencer Mode** parameter to **On**.

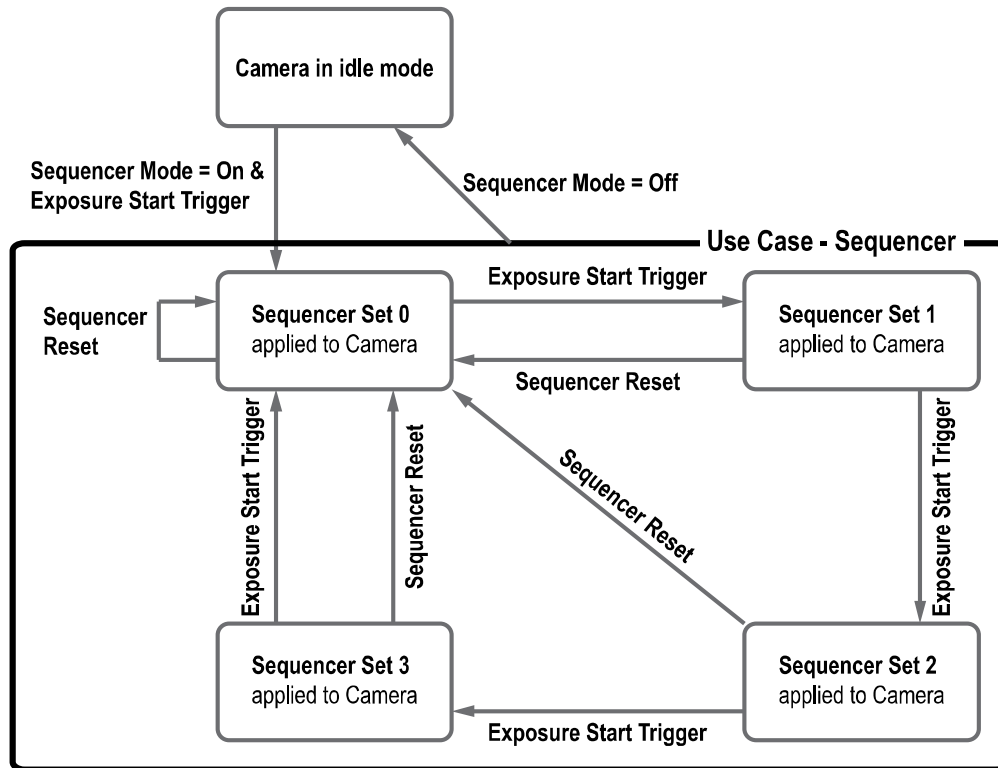

Figure 9-11 Sequencer Diagram (Use Case)



Note:

- You can save the user defined Sequencer Sets in the camera's non-volatile memory by using the User Set Control feature. For more information, refer to [9.25 User Set Control](#).
- Executing the **Sequencer Reset** parameter allows to return to the **Sequencer Set 0** status at any time while cycling through the Sequencer.

9.14 Digital I/O Control

The Control I/O receptacle of the camera can be operated in various modes.

The XML parameters related to Digital I/O Control are as follows.

XML Parameters	Value	Description	
DigitalIOControl	LineSelector	Line0	Selects the number 1 pin of the camera's Control I/O receptacle.
		Line1	Selects the number 4 pin of the camera's Control I/O receptacle.
LineMode	Input	Sets the Line Mode of the selected physical line (1) to Input.	
	Output	Sets the Line Mode of the selected physical line (4) to Output.	
LineInverter	FALSE	Disables inversion on the output signal of the line.	
	TRUE	Enables inversion on the output signal of the line.	
LineSource	Off	Disables the line output.	
	Exposure Active	Outputs pulse signals indicating the current exposure time.	
	Frame Active	Outputs pulse signals indicating a frame readout time.	
	UserOutput0	Outputs pulse signals set by User Output Value.	
	Timer0 Active	Outputs user-defined Timer signals as pulse signals.	
	Strobe	Outputs strobe signals (goes high when the exposure time for the bottom line of pixels begins and goes low when the exposure time for the top line of pixels ends) as pulse signals.	
UserOutput Selector	UserOutput0	Outputs pulse signals set by User Output Value.	
UserOutput Value	FALSE	Sets the bit state of the line to Low.	
	TRUE	Sets the bit state of the line to High.	
Debounce Time	0 ~ 1,000,000	Sets a Debounce Time in microseconds (Default: 0.5 μ s).	

Table 9-17 XML Parameters related to Digital I/O Control

When you set the **Line Source** to **User Output0**, you can use the user setting values as output signals.

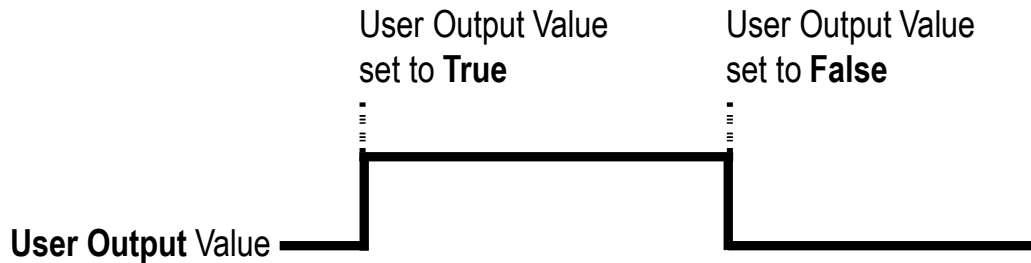

Figure 9-12 User Output

The camera can provide an Exposure Active output signal. The signal goes high when the exposure time for each frame acquisition begins and goes low when the exposure time ends as shown in the figure below. This signal can be used as a flash trigger and is also useful when you are operating a system where either the camera or the object being imaged is movable. Typically, you do not want the camera to move during exposure. You can monitor the Exposure Active signal to know when exposure is taking place and thus know when to avoid moving the camera.

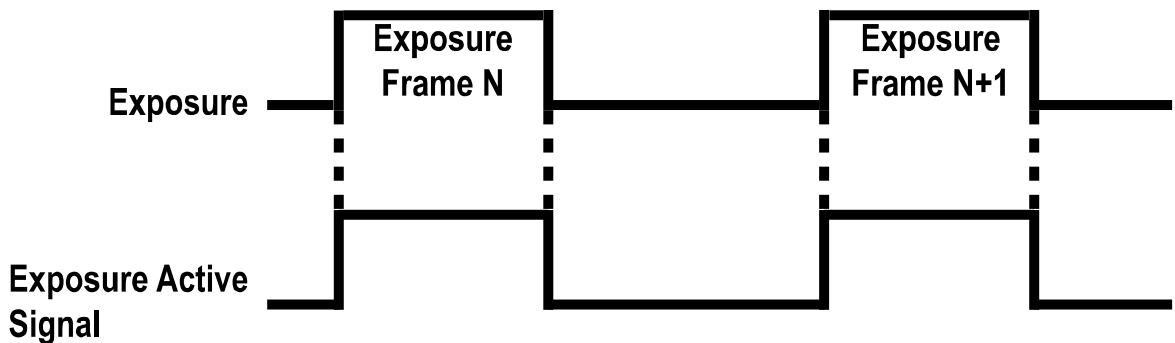

Figure 9-13 Exposure Active Signal

9.14.1 Strobe

When the **Line Source** is set to **Strobe**, the camera can output Strobe signals.

Typically, the strobe signal goes high when the exposure time begins and goes low when the exposure time ends. This signal can be used as a flash trigger and is also useful when you are operating a system where either the camera or the object being imaged is movable. Typically, you do not want the camera to move during exposure. You can monitor the Strobe signal to know when exposure is taking place and thus know when to avoid moving the camera.

The VC-61MC 13H camera provides the Strobe signal as shown in the figure below. The Strobe signal goes high when the exposure time for the bottom line of pixels begins and goes low when the exposure time for the top line of pixels ends. The Strobe signal is only available when the exposure time is longer than the readout time and is useful when you are operating the camera under the flash lighting conditions.

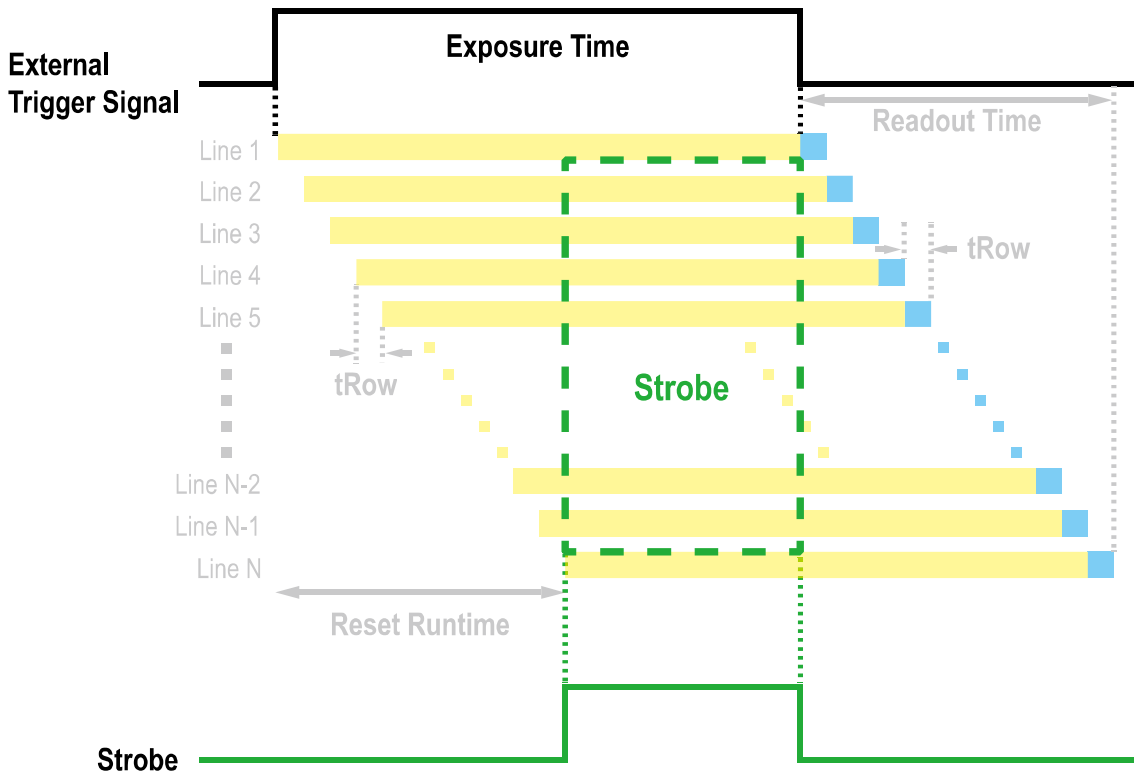

Figure 9-14 Strobe Signal

9.14.2 Debounce

The Debounce feature of the VC-61MC 13H cameras allows to supply only valid signals to the camera by discriminating between valid and invalid input signals. The Debounce Time parameter specifies the minimum time that an input signal must remain High or Low in order to be considered as a valid input signal. When you use the Debounce feature, be aware that there is a delay between the point where the valid input signal arrives and the point where the signal becomes effective. The duration of the delay is determined by the Debounce Time parameter setting value.

When you set the Debounce Time parameter, High and Low signals shorter than the setting value are considered invalid and ignored as shown in the figure below.

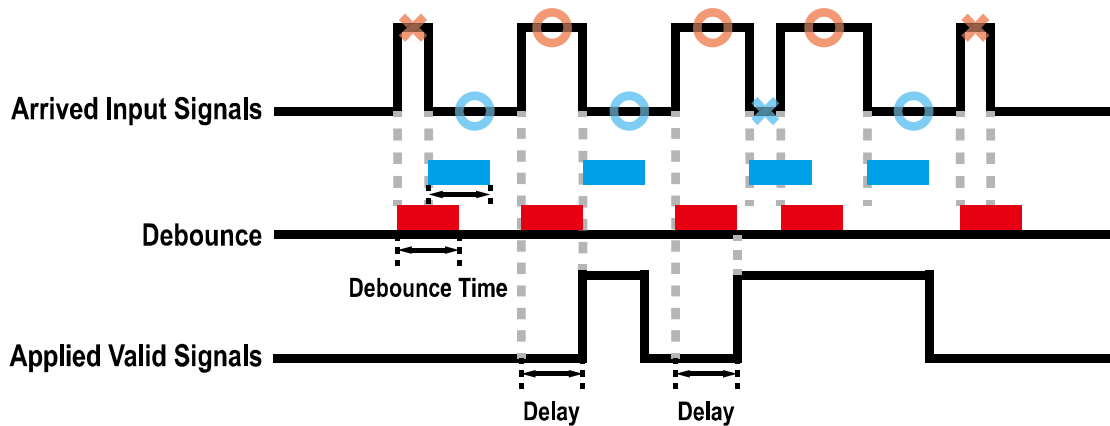

Figure 9-15 Debounce

The XML parameter related to Debounce Time is as follows.

XML Parameters		Value	Description
DigitalIOControl	Debounce Time	0 – 1,000,000 μ s	Sets a Debounce Time in microseconds (Default: 0.5 μ s).

Table 9-18 XML Parameter related to Debounce Time

9.15 Timer Control

When the **Line Source** parameter is set to **Timer0Active**, the camera can provide output signals by using the Timer. On the VC-61MC 13H camera, the Frame Active, Exposure Active event or external trigger signal is available as Timer source signal.

The XML parameters related to Timer are as follows.

XML Parameters	Value	Description	
CounterAnd TimerControl	TimerSelector	Timer0	Selects a Timer to configure.
	TimerDuration	1 ~ 60,000,000 μ s	Sets the duration of the Timer output signal to be used when Timer Trigger Activation is set to Rising/Falling Edge.
	TimerDelay	0 ~ 60,000,000 μ s	Sets the delay time to be applied before starting the Timer.
	TimerReset	-	Resets the Timer and starts it again.
	TimerValue	-	Displays the current value of the selected Timer.
TimerStatus	TimerIdle		Indicates that the Timer is in idle state.
	TimerTriggerWait		Indicates that the Timer is waiting for a trigger signal.
	TimerActive		Indicates that the Timer is in active state.
TimerTrigger Source	Off		Disables the Timer trigger.
	ExposureActive		Sets the Timer to use the current exposure time as the source signal.
	FrameActive		Sets the Timer to use a frame readout time as the source signal.
	Line0		Sets the Timer to use the external trigger signal as the source signal.
	Strobe		Sets the Timer to use the Strobe signal as the source signal.
TimerTrigger Activation	RisingEdge		Specifies that a rising edge of the selected trigger signal will act as the Timer trigger.
	FallingEdge		Specifies that a falling edge of the selected trigger signal will act as the Timer trigger.
	LevelHigh		Specifies that the Timer output signal will be valid as long as the selected trigger signal is High.
	LevelLow		Specifies that the Timer output signal will be valid as long as the selected trigger signal is Low.

Table 9-19 XML Parameters related to Timer Control

For example, when the **Timer Trigger Source** is set to **Exposure Active** and the **Timer Trigger Activation** is set to **Level High**, the Timer will act as follows.

1. When the source signals set by the **Timer Trigger Source** parameter are applied, the Timer will start operations.
2. The delay set by the **Timer Delay** parameter begins to expire.
3. When the delay expires, the Timer signal goes high as long as the source signal is high.

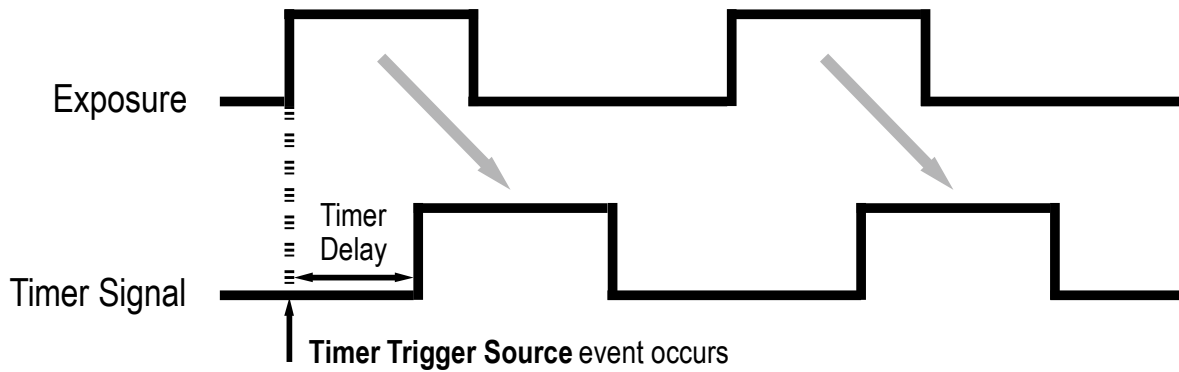

* **Timer Trigger Activation** is set to **Level High**.

Figure 9-16 Timer Signal

9.16 Cooling Control

A fan is installed on the rear panel of the camera to radiate heat. You can set the fan to turn on or off. You can also set the fan to turn on when a specified internal temperature is reached.

The XML parameters related to Cooling Control are as follows.

XML Parameters	Value	Description	
CoolingControl	TargetTemperature	-10°C ~ 80°C	Sets the temperature to operate the fan when the FanOperationMode is set to Temperature.
	FanOperationMode	Off	Turns off the fan.
		On	Turns on the fan.
		Temperature	Turns on the fan when the internal temperature exceeds the value set in the TargetTemperature parameter.
	FanSpeed	-	Displays the current Fan RPM.

Table 9-20 XML Parameters related to Cooling Control

9.17 Temperature Monitor

The camera has an embedded sensor chip to monitor the internal temperature.

The XML parameters related to Device Temperature are as follows.

XML Parameters	Value	Description	
DeviceControl	DeviceTemperatureSelector	Mainboard	Sets a temperature measuring spot to the mainboard.
		Sensor	Sets a temperature measuring spot to the image sensor.
	DeviceTemperature	-	Displays device temperature in Celsius.

Table 9-21 XML Parameters related to Device Temperature

9.18 Status LED

A LED is installed on the rear panel of the camera to inform the operation status of the camera.

LED status and corresponding camera status are as follows:

Status LED	Description
Steady Red	The camera is not initialized.
Fast Flashing Orange	The camera is transmitting image data.
Steady Green	A Camera Link stands by.

Table 9-22 Status LED

9.19 Test Pattern

To check whether the camera operates normally or not, it can be set to output test patterns generated in the camera, instead of image data from the image sensor. Four types of test patterns are available; images with different values in horizontal direction (Grey Horizontal Ramp), images with different values in diagonal direction (Grey Diagonal Ramp), moving images with different values in diagonal direction (Grey Diagonal Ramp Moving) and images with different values in horizontal direction output from the image sensor (Sensor Specific).

The XML parameter related to Test Pattern is as follows.

XML Parameter	Value	Description	
ImageFormatControl	TestPattern	Off	Disables the Test Pattern feature.
	GreyHorizontalRamp	GreyHorizontalRamp	Sets to Grey Horizontal Ramp.
	GreyDiagonalRamp	GreyDiagonalRamp	Sets to Grey Diagonal Ramp.
	GreyDiagonalRampMoving	GreyDiagonalRampMoving	Sets to Grey Diagonal Ramp Moving.
	SensorSpecific	SensorSpecific	Sets to the Test Pattern generated by the image sensor.

Table 9-23 XML Parameter related to Test Pattern

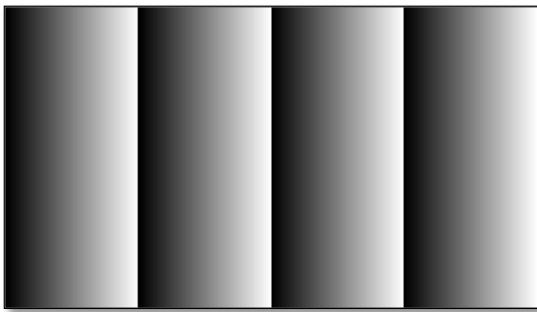

Figure 9-17 Grey Horizontal Ramp



Figure 9-18 Grey Diagonal Ramp

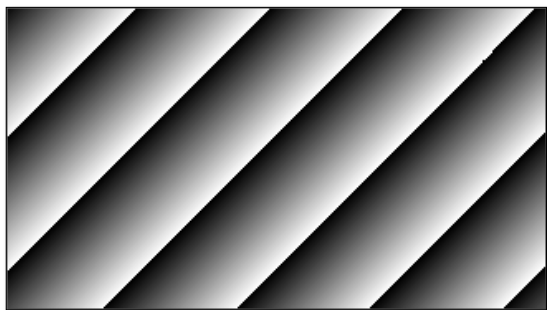

Figure 9-19 Grey Diagonal Ramp Moving

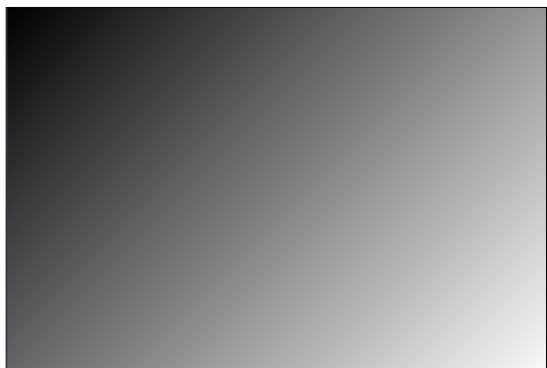

Figure 9-20 Sensor Specific



Caution!

The test pattern may look different because the region of the test pattern may vary depending on the camera's resolution.

9.20 Reverse X

The Reverse X feature lets you flip images horizontally. This feature is available in almost all of operation modes of the camera, except for the **Test Image** mode.

XML Parameter		Value	Description
ImageFormatControl	ReverseX	FALSE	Disables the Reverse X feature.
		TRUE	Flips images horizontally.

Table 9-24 XML Parameter related to Reverse X



Figure 9-21 Original Image



Figure 9-22 Reverse X Image

9.21 Device Link Throughput Limit

The **Device Link Throughput Limit** feature allows you to limit the maximum available bandwidth for data transmission to your computer.

The XML parameter related to Device Link Throughput Limit is as follows.

XML Parameters		Description
DeviceControl	DeviceLinkThroughputLimit	Limits the maximum available bandwidth (bps).

Table 9-25 XML Parameter related to Device Link Throughput Limit



Caution!

To ensure good image quality, we recommend that you set the **Device Link Throughput Limit** parameter to the maximum value. Otherwise, the image quality can decrease. In case of the VC-61MC 13H, its maximum value is 1700.

9.22 Device User ID

You can input user-defined information up to 64 bytes.

The XML parameter related to Device User ID is as follows.

XML Parameter		Description
DeviceControl	DeviceUserID	Input user-defined information (64 bytes).

Table 9-26 XML Parameter related to Device User ID

9.23 Device Reset

Resets the camera physically to power off and on.

The XML parameter related to Device Reset is as follows.

XML Parameter		Description
DeviceControl	Device Reset	Resets the camera physically.

Table 9-27 XML Parameter related to Device Reset

9.24 Field Upgrade

The camera provides a feature to upgrade the Firmware and FPGA logic through the Camera Link interface without disassembling the camera in the field. Refer to [Appendix A](#) for more details about how to upgrade.

9.25 User Set Control

You can save the current camera settings to the camera's internal Flash memory. You can also load the camera settings from the camera's internal Flash memory. The camera provides two setups to save and three setups to load settings.

The XML parameters related to User Set Control are as follows.

XML Parameters	Value	Description	
UserSetControl	UserSetSelector	Default	Selects the Factory Default settings.
		UserSet1	Selects the UserSet1 settings.
		UserSet2	Selects the UserSet2 settings.
UserSetLoad	-	Loads the User Set specified by User Set Selector to the camera.	
UserSetSave	-	Saves the current settings to the User Set specified by User Set Selector. The Default is a Factory Default Settings and allowed to load only.	
UserSetDefault		Default	Applies the Factory Default settings when reset.
		UserSet1	Applies the UserSet1 when reset.
		UserSet2	Applies the UserSet2 when reset.

Table 9-28 XML Parameters related to User Set Control

The camera settings stored in the Default can be loaded into the camera's workspace but cannot be changed. The settings set in the workspace will be lost if the camera is reset or powered off. To use the current setting values in the workspace after a reset, you must save the settings to one of the user spaces.

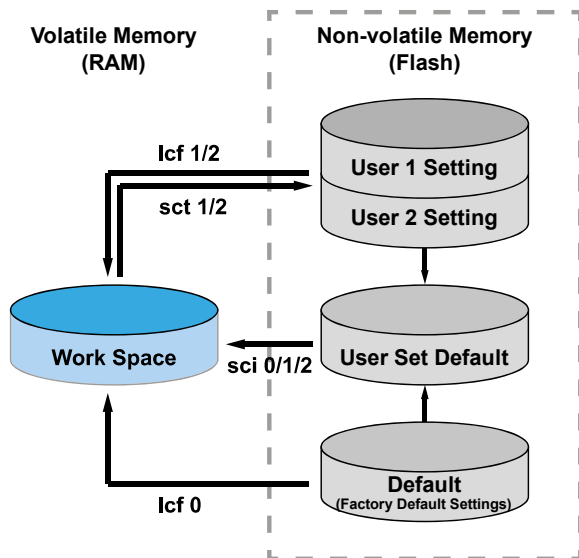

Figure 9-23 User Set Control

Chapter 10. Camera Configuration

10.1 Serial Communication

You can configure all camera settings via RS-644 serial communication of the Camera Link interface. When you want to control the camera by using a terminal or access directly to the camera by using your application, you need to set your network as follows:

- Baud Rate: 1152200 bps
- Data Bit: 8 bit
- Parity Bit: No parity
- Stop Bit: 1 stop bit
- Flow Control: None

10.2 Actual Runtime of Parameters

When you set a parameter, the actual runtime of the parameter varies depending on the type of the parameter and the operating status of the camera. All parameters except the Exposure Time parameter are applied to change the camera settings as illustrated below, on the rising edge of a REQ_Frame signal before starting the readout process. When you change the Exposure Time parameter, the exposure time setting will be changed and applied at the starting of the exposure. If you operate the camera with the Trigger Mode parameter set to On, you must change parameters before applying the trigger signals in order to synchronize image outputs with the parameters. If you change a parameter in the Free-Run mode, you may acquire up to two images that are not affected by the parameter change. This is true because it is hard to verify the current operating status of the camera in the Free-Run mode.

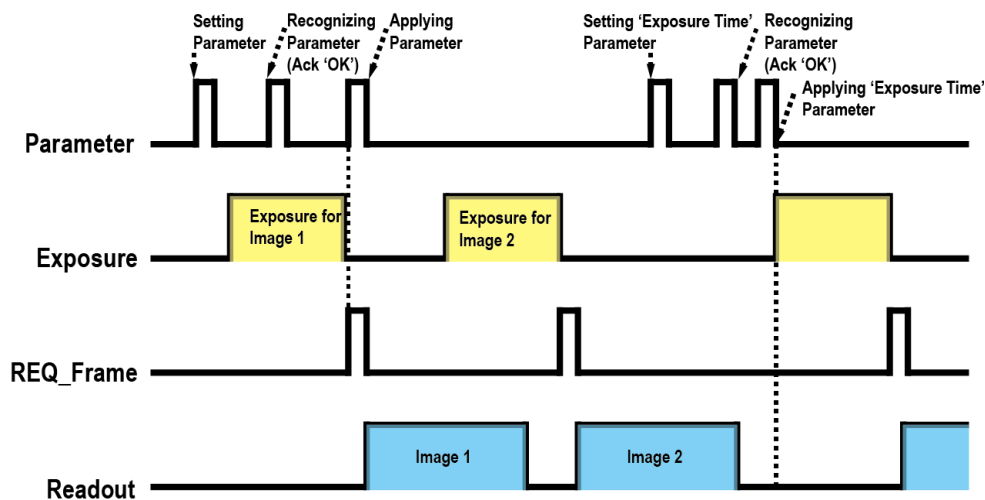

Figure 10-1 Actual Runtime of Parameters

10.3 Configurator

The Configurator, a sample application, is provided to control Vieworks Camera Link cameras. The Configurator allows you to change the camera's parameters and control the camera.

Starting the Configurator

After connecting the camera to your computer (refer to [Chapter 6 Connecting the Camera](#), you can run the Configurator by following the procedure below.

1. Execute the Configurator.exe file after the camera is powered on. The **Camera Scan** window appears.
2. The Configurator probes if a camera is connected to your computer and then displays the model name of the connected camera in the **Camera Scan** window.
3. Right-click the model name of the camera, and then click the **Add to List** menu. By adding a Vieworks Camera Link camera which supports XML-based control to the list, you can configure the camera with a newer version of the Configurator.

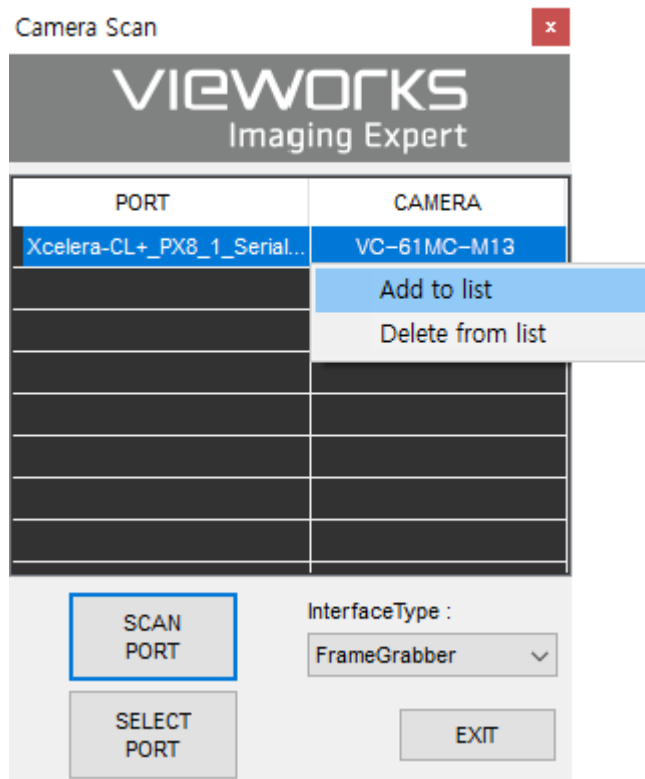

Figure 10-2 Add to list in the Camera Scan window

4. Double-click the model name of the camera. The **Device Property** and **Configurator Plus** windows appear.

The **Device Property** window displays controls for setting camera parameters.

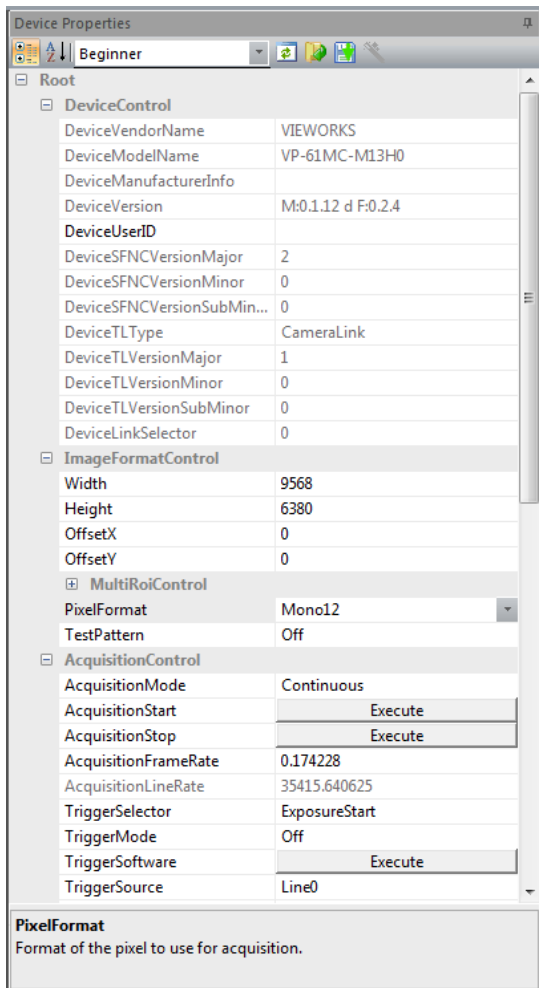

Figure 10-3 Device Property

In the **Configurator Plus** window, you can display the **Device Property** and/or **Device Maintenance** windows. In the **Device Maintenance** window, you can download a Defective Pixel Map or upgrade camera's MCU, FPGA and XML files.

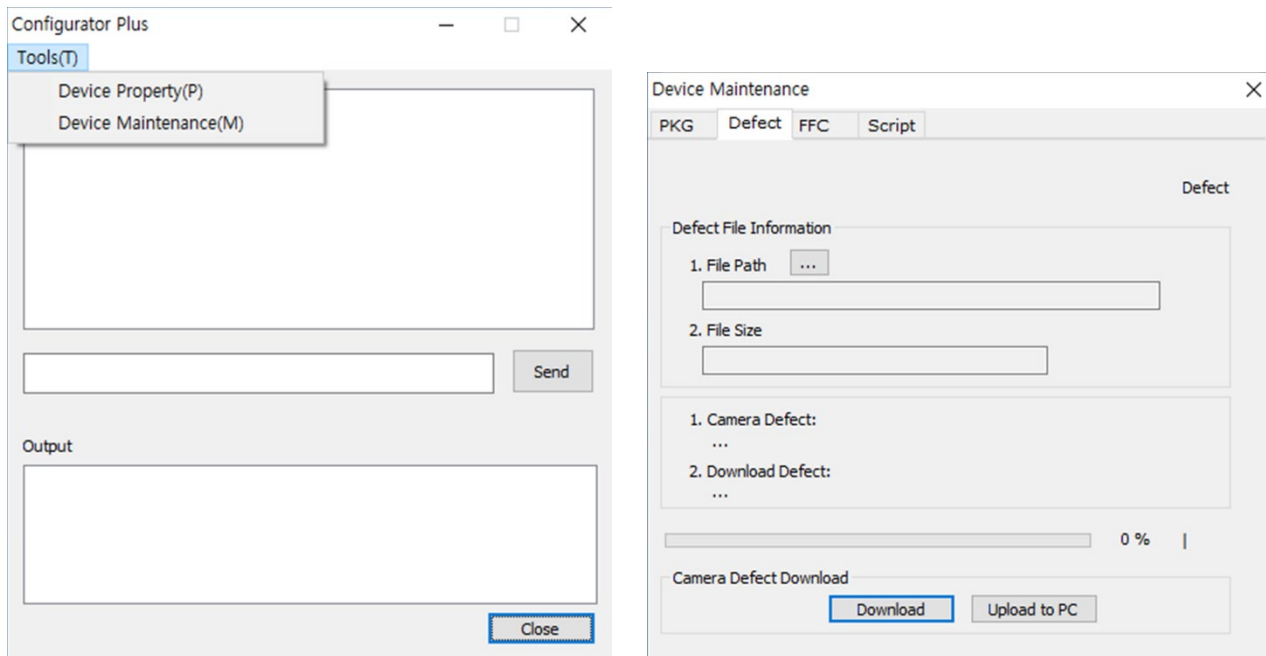

Figure 10-4 Configurator Plus and Device Maintenance

10.4 Command List

You can set all features provided by the VC-61MC 13H camera by using the following commands.

Command	Syntax	Return Value	Description
Help	help	String	Displays a list of all commands.
Set ROI Offset X Get ROI Offset X	sox n gox	OK n	X coordinate of start point ROI n: X axis offset
Set ROI Offset Y Get ROI Offset Y	soy n goy	OK n	Y coordinate of start point ROI n: Y axis offset
Set Image Width Get Image Width	siw n giw	OK n	Sets a width of the Image ROI. n: Width value
Set Image Height Get Image Height	sih n gih	OK n	Sets a height of the Image ROI. n: Height value
Set Binning Selector Get Binning Selector	sbns 0 1 gbns	OK 0 1	Selects the Binning engine. 0: Sensor 1: Logic
Set Binning Horizontal Mode Get Binning Horizontal Mode	sbhm 0 1 gbhm	OK 0 1	Sets the Binning mode to apply to Binning Horizontal. 0: Sum 1: Average
Set Binning Horizontal Get Binning Horizontal	sbh 1 2 3 4 gbh	OK 1 2 3 4	The number of horizontal pixels to combine together. Sensor - 1 2 3: ×1, ×2, ×3 Logic - 1 2 4: ×1, ×2, ×4
Set Binning Vertical Mode Get Binning Vertical Mode	sbvm 0 1 gbvm	OK 0 1	Sets the Binning mode to apply to Binning Vertical. 0: Sum 1: Average
Set Binning Vertical Get Binning Vertical	sbv 1 2 3 4 gbv	OK 1 2 3 4	The number of vertical pixels to combine together. Sensor - 1 2 3: ×1, ×2, ×3 Logic - 1 2 4: ×1, ×2, ×4
Acquisition Start	ast	OK	Starts image acquisitions.
Acquisition Stop	asp	OK	Stops image acquisitions.

Table 10-1 Command List #1

Command	Syntax	Return Value	Description
Set Test Image Get Test Image	sti 0 1 2 3 16 gti	OK 0 1 2 3 16	Sets the Test Image. 0: Disables the Test Image feature. 1: Sets to Grey Horizontal Ramp. 2: Sets to Grey Diagonal Ramp. 3: Sets to Grey Diagonal Ramp Moving. 16: Sets to the Test Image provided by the image sensor.
Set Camera Link Tap Geometry Get Camera Link Tap Geometry	stg 2 4 8 10 gtg	OK 2 4 8 10	Sets the Camera Link Tap Geometry. 2: 1X2-1Y (2 Tap) 4: 1X4-1Y (4 Tap) 8: 1X8-1Y (8 Tap) 10: 1X10-1Y (10 Tap)
Set Data Bit Get Data Bit	sdb 8 10 12 gdb	OK 8 10 12	Sets the Pixel Format. 8: 8 bit 10: 10 bit 12: 12 bit
Set Camera Link Clock Selector Get Camera Link Clock Selector	sccs 0 1 gccs	OK 0 1	Sets the Camera Link Pixel Clock speed. 0: 85 MHz 1: 65 MHz
Set Defect Correction Get Defect Correction	sdc 0 1 gdc	OK 0 1	Sets the Defect Pixel Correction. 0: Disables the Defect Pixel Correction. 1: Enables the Defect Pixel Correction.
Set Horizontal Flip Get Horizontal Flip	shf 0 1 ghf	OK 0 1	Sets the Reverse X (Horizontal Flip). 0: Disables the Reverse X. 1: Enables the Reverse X.
Set Acquisition Mode Get Acquisition Mode	sam 0 gam	OK 0	Sets the Acquisition Mode. 0: Continuous
Set Trigger Mode Get Trigger Mode	stm 0 1 gtm	OK 0 1	Sets the Trigger Mode. 0: Trigger Mode Off (Free run mode) 1: Trigger Mode On

Table 10-2 Command List #2

Command	Syntax	Return Value	Description
Set Exposure Mode Get Exposure Mode	sem/ses 0 1 gem/ges	OK 0 1	Sets the Exposure mode. 0: Timed 1: Trigger Width
Set Trigger Source Get Trigger Source	sts 3 10 14 18 22 gts	OK 3 10 14 18 22	Specifies a source signal when the Trigger Mode is set to On. 3: Software 10: User Output0 14: CC1 18: Timer0 Active 22: Line0
Generate SW Trigger	nst	OK	Generates a Software trigger signal.
Set Trigger Activation Get Trigger Activation	sta 0 1 gta	OK 0 1	Sets the activation mode for the selected source signal when Trigger Mode is set to On. 0: Falling Edge 1: Rising Edge
Set Exposure Time Get Exposure Time	set n get	OK n	Sets an exposure time. n: Exposure time in microseconds (Setting range: 22.72 μ s – 60 s @ 10 Tap)
Set Frame Rate Get Frame Rate	sfr n gfr	OK n	Sets the rate at which the exposure start trigger will be generated when the Trigger Mode is set to Off.
Get Acquisition Status	gast	0 1	Retrieves the internal acquisition status. 0: The camera is not in the process of acquiring a frame. 1: The camera is in the process of acquiring a frame.
Set Black Level Get Black Level	sbl n gbl	OK n	Sets the black level value. n: Black Level (Setting range: 0 ~ 255)
Set analog Gain Get analog Gain	sag n gag	OK n	Sets the analog gain value. n: Gain (Setting range: 1 \times ~ 32 \times)
Set Digital Gain Get Digital Gain	sdg n gdg	OK n	Sets the digital gain value. n: Gain (Setting range: 1 \times ~ 32 \times)

Table 10-3 Command List #3

Command	Syntax	Return Value	Description
Generate Flat Field Data	gfd none 0 n	OK	Executes the Flat Field Generator. none / 0: Auto-adjusts the target value of the image after correction. n: Manually sets the target value of the image after correction (1 ~ 4095 @ 12 bit).
Set Flat Field Data Selector Get Flat Field Data Selector	sfds 0 1 ... 31 gfds	OK 0 1 ... 31	Selects a Flat Field correction data location. Mono: Space0 – Space31 Color: Space0 – Space15
Save Flat Field Data	sfd	OK	Saves the generated Flat Field correction data in the selected FFC data location.
Load Flat Field Data	lfd	OK	Loads the FFC data from the non-volatile memory into the volatile memory.
Set Flat Field Correction Get Flat Field Correction	sfc 0 1 gfc	OK 0 1	Sets the Flat Field Correction feature. 0: Disables the Flat Field Correction. 1: Enables the Flat Field Correction.
Set Point DSNU Correction Get Point DSNU Correction	sdsnup 0 1 gdsnup	OK 0 1	Sets the Hot Pixel Correction feature. 0: Disables the Hot Pixel Correction. 1: Enables the Hot Pixel Correction.
Set Fan Mode Get Fan Mode	sfm 0 1 2 gfm	OK 0 1 2	Sets the Fan operation mode. 0: Fan Off 1: Fan On 2: Temperature
Set Target Temperature Get Target Temperature	stt n gtt	OK n	Sets the temperature to operate the fan when the Fan Mode is set to Temperature. n: -10°C ~ 80°C
Set Line Selector Get Line Selector	slns 0 1 glns	OK 0 1	Selects a physical line of the Control I/O receptacle to configure. 0: Line0 1: Line1

Table 10-4 Command List #4

Command	Syntax	Return Value	Description
Get Line Mode	glnm	0 1	Retrieves the mode of the selected physical line. 0: Input 1: Output
Set Line Source Get Line Source	slnc 0 4 6 10 18 30 glnlc	OK 0 4 6 10 18 30	Specifies a source signal for the Control I/O receptacle. 0: Disables the Line input/output. 4: Frame Active 6: Exposure Active 10: User Output0 18: Timer0 Active 30: Strobe
Set Line Inverter Get Line Inverter	slni 0 1 glni	OK 0 1	Sets whether to invert the line output. 0: Disables inversion on the line output. 1: Enables inversion on the line output.
Set User Output Value Get User Output Value	suov 0 1 guov	OK 0 1	Sets the User Output value. 0: Sets the bit state of the line to Low. 1: Sets the bit state of the line to High.
Set Timer Trigger Source Get Timer Trigger Source	stts 0 4 6 22 30 gtts	OK 0 4 6 22 30	Specifies the source signal for the Timer output signal. 0: Disables the Timer trigger. 4: Frame Active 6: Exposure Active 22: Line0 30: Strobe
Set Timer Duration Get Timer Duration	stdu n gtdu	OK n	Sets the duration of the Timer output signal. n: 1 – 60,000,000 μ s
Set Timer Delay Get Timer Delay	stdl n gtdl	OK n	Sets the delay time for the Timer. n: 0 – 60,000,000 μ s
Set Timer Trigger Activation Get Timer Trigger Activation	stta 0 1 2 3 gtta	OK 0 1 2 3	Sets the activation mode for the Timer. 0: Falling Edge 1: Rising Edge 2: Level Low 3: Level High

Table 10-5 Command List #5

Command	Syntax	Return Value	Description
Reset Timer	rtmr	OK	Resets the Timer and starts it again.
Get Timer Status	gtst	0 1 2	Displays the status of the Timer. 0: Timer Idle 1: Timer Trigger Wait 2: Timer Active
Set Debounce Time	sdbt n	OK	Sets the Debounce time.
Get Debounce Time	gdbt	n	n: Debounce time in microseconds (0 – 1,000,000 μ s)
Set Sequencer Mode	ssqm 0 1	OK	Sets the Sequencer mode.
Get Sequencer Mode	gsqm	0 1	0: Disables the Sequencer Mode. 1: Enables the Sequencer Mode.
Set Sequencer Config. Mode	ssqcm 0 1	OK	Sets the Sequencer Configuration mode.
Get Sequencer Config. Mode	gsqcm	0 1	0: Disables the Sequencer Config. mode. 1: Enables the Sequencer Config. mode.
Set Sequencer Set Selector	ssqss n	OK	Selects an index number of a Sequencer Set to be configured.
Get Sequencer Set Selector	gsqss	n	n: Sequencer Set index number (0 ~ 31)
Set Sequencer Set Count	ssqsc n	OK	Sets the number of Sequencer Sets to be applied.
Get Sequencer Set Count	gsqsc	n	n: 1 ~ 32
Get Sequencer Set Active	gsqsa	n	Displays the index number of the Sequencer Set that is currently active. n: 0 ~ 31
Reset Sequencer	rsq	OK	Returns to Sequencer Set 0.
Set AWB Offset X	swx n	OK	Sets a horizontal offset from the origin to the Data ROI.
Get AWB Offset X	gwx	n	
Set AWB Offset Y	swy n	OK	Sets the vertical offset from the origin to the Data ROI.
Get AWB Offset Y	gwy	n	
Set AWB Width	sww n	OK	Sets a width for the Data ROI.
Get AWB Width	gww	n	
Set AWB Height	swh n	OK	Sets a height for the Data ROI.
Get AWB Height	gwh	n	

Table 10-6 Command List #6

Command	Syntax	Return Value	Description
Set RGB Gain Get RGB Gain	srg r g b n grg r g b	OK n	Sets the intensity of color pixels. r g b: Red / Green / Blue pixels n: Gain value (1.0× ~ 4.0×)
Auto White Balance	arg	OK	Automatically adjusts the white balance once.
Load Config. From	lcf 0 1 2	OK	Loads the camera setting values. 0: Loads the Factory Default Setting. 1: Loads the User 1 Setting. 2: Loads the User 2 Setting.
Save Config. To	sct 1 2	OK	Saves the current camera setting values. 1: Saves to the User 1 Setting. 2: Saves to the User 2 Setting.
Set Config. Initialization Get Config. Initialization	sci 0 1 2 gci	OK 0 1 2	Specifies setting values to be loaded when reset. 0: Factory Default Setting 1: User 1 Setting 2: User 2 Setting
Get Model Name	gmn	String	Displays the camera model name.
Get MCU Version	gmv	String	Displays the version of the camera MCU.
Get FPGA Version	gfv	String	Displays the version of the camera FPGA.
Get Serial Number	gsn piece	String	Displays the serial number of the camera.
Get Current Temperature	gct	String	Displays device temperature in Celsius.
Get Fan RPM	gfrpm	String	Displays the Fan RPM.
Reset Hardware	rst	-	Resets the camera physically to power off and on.

Table 10-7 Command List #7

Chapter 11. Troubleshooting

When you have a problem with a Vieworks camera, please check the followings:

- If no image is displayed on your computer,
 - Ensure that all cable connections are secure.
 - Ensure that the power supply is properly connected.
 - Ensure that trigger signals are applied correctly when you operate the camera with trigger signals.

- If images are not clear,
 - Ensure the camera lens or glass is clean.
 - Check the lens aperture is adjusted properly.

- If images are dark,
 - Ensure the camera lens is not blocked.
 - Check the exposure time is set properly.

- If you identify abnormal operation or overheating sign,
 - Ensure the power supply is properly connected.
 - Stop using the camera when you notice smoke or abnormal overheating.

- If the Trigger Mode is not working correctly,
 - Ensure that the CC1 settings on the frame grabber are configured correctly when you use CC1 triggering.
 - Ensure that cable connections are secure when you use external triggering.

- If there is a communication failure between the camera and user's computer,
 - Ensure that the Camera Link cable connections are secure.
 - Ensure that you have configured a frame grabber in your computer and the camera is connected to the frame grabber correctly.

Appendix A. Defective Pixel Map Download

1. Create the Defective Pixel Map data in Microsoft Excel format as shown in the left picture below and save as a CSV file (*.csv). The picture in the right shows the created Excel file opened in Notepad. The following rules need to be applied when creating the file.

- Lines beginning with ':' or '--' are treated as notes.
- You must enter the horizontal value first and then the vertical value for coordinates of each defect pixel.
- Coordinate values for each pixel can be placed in any order.

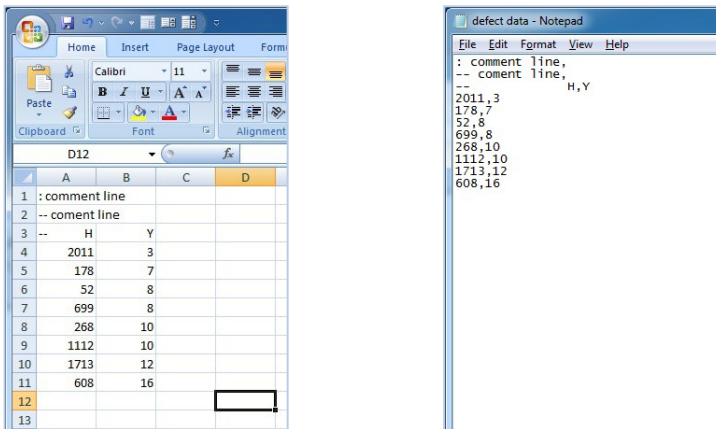

2. Run the application provided by your frame grabber to update or download the Defective Pixel Map data, and then find the window to function as shown below. Select the **Defect** tab, click the **File Path** item, search and select the defective pixel map (*.csv), and then click the **Download** button.

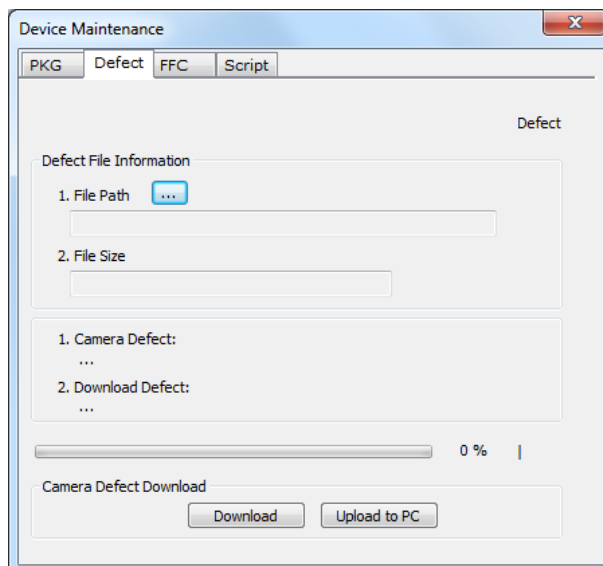

Appendix B. Field Upgrade

You can upgrade the MCU, FPGA and XML file of the camera by following the procedure below.

1. Run the application provided by your frame grabber, and then find the menu to support the necessary function.
2. Select the **PKG** tab, on the window below, click the button next to **File Path**, search and select the MCU, FPGA or XML upgrade file, and then click the **Download** button.

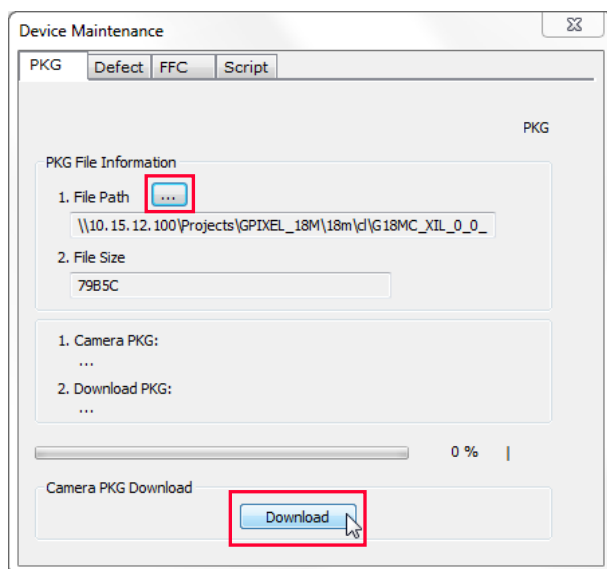

3. The camera begins downloading the upgrade file and the downloading status is displayed at the bottom of the window.

Appendix C. Index

6

6-pin connector.....33

A

acquisition control.....36

Acquisition Mode

 Continuous parameter.....38

Acquisition Mode parameter38

Acquisition Start command.....38

Acquisition Stop command.....38

any edge.....43

application.....7

B

back panel.....30

Bayer GB 8/10/1264

block diagram24

C

Camera Link connector..... 30, 31

camera ON&OFF89

camera's pixel formats.....64

camera's temperature, parameters85

CC140

CC1 Trigger.....46

circuit35

Configurator7, 29

Configurator download.....29

connector of Camera Link.....31

Continuous parameter.....38

D

defect pixel.....70

diagram.....24

dimension26

downloading Configurator.....29

E

Exposure Mode	
Timed	41
Trigger Width.....	41
Exposure Mode parameter	41

F

falling edge	43
FFC.....	72
Flat Field Correction data, generation.....	72
Free-run.....	41

G

gain value, setting	69
generating data of Flat Field correction.....	72

H

hardware trigger signal	47
Hirose	33
Hirose 6-pin connector.....	33

I

inputting information of user's choice.....	89
---	----

K

key features	22
--------------------	----

L

LED status	85
level high	43
level low.....	43
Line0	40

M

main features.....	22
mechanical dimension	26
Mono 8/10/12	64

O

offset to pixel.....	69
offset value, setting	69
OffsetX.....	59
OffsetY.....	59

P

pixel formats.....	64
preface.....	3, 7
PRNU.....	71
product	7

R

relative sensitivity.....25

reset physically89

rising edge43

ROI59

ROI-origin position.....60

ROI-size setting.....60

S

schematic diagram.....35

SDR connector31

Software40

specification.....23

strobe output35

T

tilt settings 29

Timed 41

Timer0Active 40

Trigger Activation parameter 43

trigger input..... 35

Trigger Mode

 off 39

 on 39

Trigger Signals 40

Trigger Source

 CC1 40

 Line0..... 40

 Software..... 40

 Timer0Active 40

 UserOutput0..... 40

Trigger Source parameter 40

Trigger Width..... 41

Trigger Width mode 50

U

UserOutput0..... 40

V

VC-61MC 13H specification..... 23

X

XML parameter

Analog Control.....	69
AnalogControl.....	68
AnyEdge.....	83
BalanceRatio.....	68
BalanceRatioSelector.....	68
BalanceWhiteAuto.....	68
BlackLevel.....	69
BlackLevelSelector.....	69
CC1.....	83
CounterAndTimeControl.....	83
DataRoiControl.....	67
Debounce Time.....	82
DebounceTime.....	79
Device Reset.....	89
DeviceControl.....	85, 89
DeviceLinkThroughputLimit.....	89
DeviceTapGeometry.....	65
DeviceTemperature.....	85
DeviceTemperatureSelector.....	85
DeviceUserID.....	89
DigitalIOControl.....	79, 82
ExposureActive.....	79, 83
FallingEdge.....	83
Flat Field Data Selector.....	75
FlatFieldControl.....	73
FlatFieldCorrection.....	73
FlatFieldDataGenerate.....	73
FlatFieldDataLoad.....	73
FlatFieldDataSave.....	73
FlatFieldDataSelector.....	73
FrameActive.....	79, 83
Gain.....	69
GainSelector.....	69
Geometry_1X10_1Y.....	65
Geometry_1X2_1Y.....	65
Geometry_1X4_1Y.....	65
Geometry_1X8_1Y.....	65
GreyDiagonalRamp.....	86
GreyDiagonalRampMoving.....	86
GreyHorizontalRamp.....	86
Height.....	60
HeightMax.....	60
ImageFormatControl.....	60, 64, 86, 88
Input.....	79
LevelHigh.....	83
LevelLow.....	83
Line 0.....	79
Line 1.....	79
Line0.....	83
LineInverter.....	79
LineMode.....	79
LineSelector.....	79
LineSource.....	79
OffsetX.....	60
OffsetY.....	60
Output.....	79
PixelFormat.....	64
ReverseX.....	88
RisingEdge.....	83
RoiHeight.....	67
RoiOffsetX.....	67
RoiOffsetY.....	67
RoiSelector.....	67
RoiWidth.....	67
SensorHeight.....	60
SensorSpecific.....	86
SensorWidth.....	60
TestPattern.....	86
Timer0Active.....	79
TimerDelay.....	83
TimerDuration.....	83
TimerReset.....	83
TimerTriggerActivation.....	83
TimerTriggerSource.....	83
TransportLayerControl.....	65
UserDefault.....	90
UserOutput0.....	79
UserOutputValue.....	79
UserSet1.....	90
UserSet2.....	90
UserSetControl.....	90
UserSetLoad.....	90
UserSetSave.....	90
UserSetSelector.....	90
White Balance Auto.....	67
Width.....	60
WidthMax.....	60

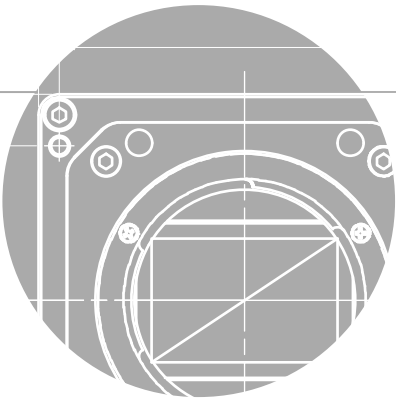
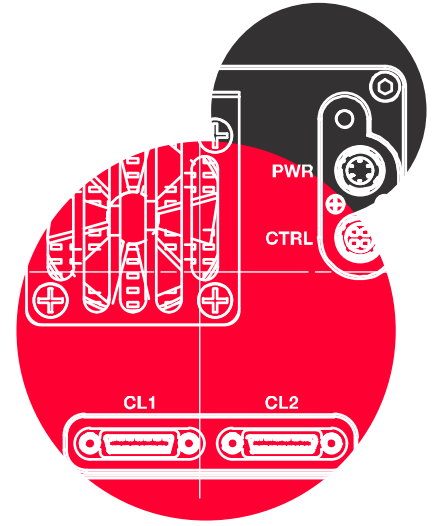
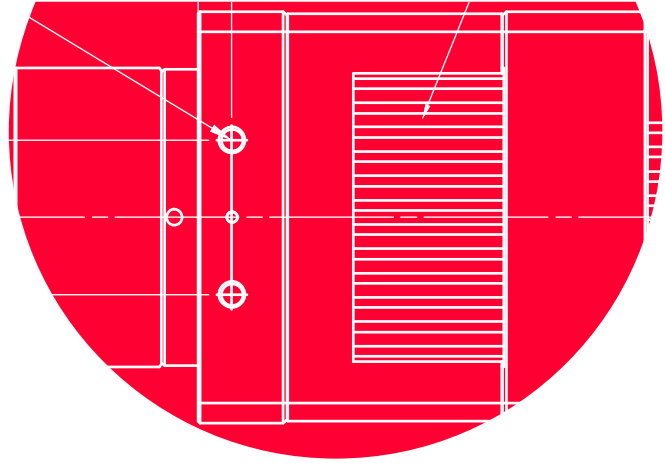

Vieworks Co., Ltd.

41-3, Burim-ro, 170beon-gil,
Dongan-gu, Anyang-si, Gyeonggi-do
14055 Republic of Korea

Tel: +82-70-7011-6161

Fax: +82-31-386-8631

<http://vision.vieworks.com>

vision@vieworks.com