

# VC series

## User Manual

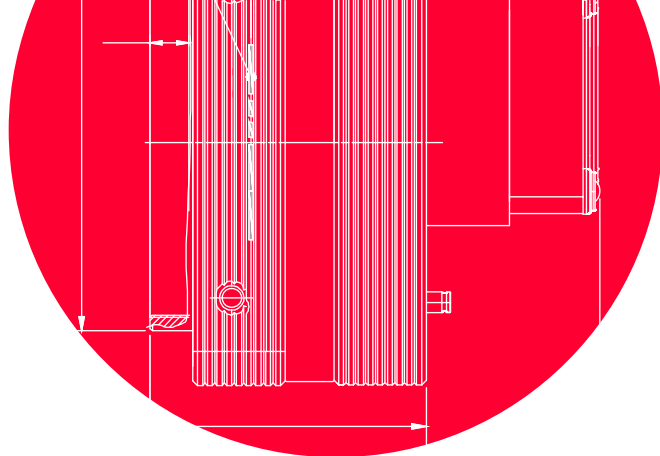

English

VC-101MX-M/C 9 H  
VC-151MX-M/C 6 H

**CoaxPress**<sup>®</sup>

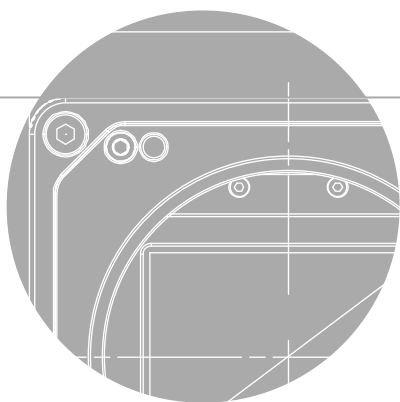

# VIEWWORKS

## **Preface**

No part of this manual may either be copied, reproduced, translated, or published in any form or by any means (electronic, mechanical, photocopying, or otherwise) without the express written permission of Vieworks, Co., Ltd. (hereinafter 'Vieworks').

This manual may include the website links to companies other than Vieworks. Vieworks is not responsible for any of these links. The copyrights of the materials mentioned herein are owned by each respective author.

Although Vieworks made every effort to ensure the accuracy of this document, it assumes no responsibility for errors or omissions that may appear herein. The figures in this manual may differ depending on the version of the product or operating system, or the way how it runs. Information in this manual is subject to change without notice.

## Before Using This Product

Thank you for choosing VC-101MX/151MX™.

- Make sure to read this manual before using the product.
- Make sure to check whatever a professional engineer has finished installation and configuration.
- Make sure to keep this manual at hand as a reference while using the product.
- This manual assumes that you have expertise in how to use an industrial camera.

## The Series

This manual is intended for users of the following products:

- VC-101MX/151MX

## About This Manual

This manual is intended for VC-101MX/151MX™ camera users. It is recommended to refer to the Frame Grabber's User Manual of yours, with this manual.

## Convention in This Manual

For better understanding, the following conventions are used throughout the manual.

### Names and Fonts

The names and fonts of user interfaces are used as follows:

- The menu and icon names in this manual are used as displayed in the product.
- The menu and icon names are marked in this font.
- Button or keyboard key names are marked in this font.

### Warning, Caution, and Note

This manual shows warnings, cautions, and notes with the following figures:



#### Warning!

This indicates that you need to follow this message for your safety and to prevent the product from damage.

---



#### Caution!

This indicates that you need to follow this message to prevent data from being lost or corrupted.

---



#### Note:

This indicates that this message provides additional information.

---

## Definition of Terms

For clarity, this manual defines some terms as follows:

Term	Definition
Preface	The introductory part preceding the Table of Contents in this manual
Vieworks Imaging Solution	Indicates the control software provided with the product together by Vieworks
VIS	Vieworks Imaging Solution

## Revision History

This document has the revision history as follows:

Version	Date	Description
1.0	2019-05-24	Initial Release
1.1	2020-11-06	Added support for 14-bit and 16-bit Pixel Formats Added support for CXP-3/6 X1 and CXP-3/6 X2 Added the Binning feature Added the Flat Field Target Selector and Flat Field Target Level
1.2	2021-03-15	Corrected the mistyped voltage range for the trigger input (Table 7-3)
1.3	2022-11-25	Revised the document template

## Contents

<b>Chapter 1. Precautions .....</b>	<b>13</b>
<b>Chapter 2. Warranty .....</b>	<b>14</b>
<b>Chapter 3. Compliance &amp; Certifications .....</b>	<b>15</b>
3.1    FCC Compliance .....	15
3.2    CE: DoC.....	15
3.3    KC .....	15
<b>Chapter 4. Package Component.....</b>	<b>16</b>
<b>Chapter 5. Product Specifications.....</b>	<b>17</b>
5.1    Overview .....	17
5.2    Specifications .....	18
5.3    Camera Block Diagram .....	19
5.4    Spectral Response .....	20
5.4.1    Monochrome Spectral Response .....	20
5.4.2    Color Spectral Response.....	22
5.5    Mechanical Specification .....	24
<b>Chapter 6. Connecting the Camera.....</b>	<b>26</b>
6.1    Precaution to Center the Image Sensor .....	27
6.2    Precaution about Blurring Compared to the Center.....	27
6.3    Installing Vieworks Imaging Solution .....	27
<b>Chapter 7. Camera Interface.....</b>	<b>28</b>
7.1    General Description.....	28
7.2    CoaXPress Connector .....	30
7.2.1    CoaXPress Connector (75 $\Omega$ DIN 1.0/2.3 Receptacle).....	30
7.3    Power Input Receptacle .....	31
7.4    Control I/O Receptacle .....	32
7.5    Trigger Input Circuit.....	33
7.6    Strobe Output Circuit .....	33
<b>Chapter 8. Acquisition Control.....</b>	<b>34</b>

8.1	Overview .....	34
8.2	Acquisition Start/Stop Commands and Acquisition Mode.....	37
8.3	Exposure Start Trigger .....	38
8.3.1	Trigger Mode .....	38
8.3.2	Using a Software Trigger Signal.....	41
8.3.3	Using a CoaXPress Trigger Signal.....	42
8.3.4	Using an External Trigger Signal .....	43
8.3.5	Exposure Mode .....	45
8.4	Setting the Exposure Time .....	47
8.5	Overlapping Exposure with Sensor Readout .....	48
8.5.1	Overlapped.....	48
8.5.2	Non-overlapped .....	49
8.6	Rolling Shutter .....	50
8.7	Maximum Allowed Frame Rate.....	52
8.7.1	Increasing the Maximum Allowed Frame Rate .....	52
<b>Chapter 9. Camera Features.....</b>		<b>53</b>
9.1	Image Region of Interest.....	53
9.2	Binning (Monochrome Only) .....	56
9.3	CXP Link Configuration.....	58
9.4	Pixel Format.....	59
9.5	Data ROI (Color Camera).....	60
9.6	White Balance (Color Only).....	61
9.6.1	Balance White Auto .....	61
9.7	Gain and Black Level .....	62
9.8	Hot Pixel Correction .....	63
9.9	Dynamic Defective Pixel Correction .....	63
9.10	Defective Pixel Correction .....	65
9.10.1	Correction Method.....	65
9.11	Flat Field Correction.....	66

---

9.12	Digital I/O Control .....	71
9.13	Timer Control .....	75
9.14	Cooling Control.....	76
9.15	Temperature Monitor.....	77
9.16	Status LED .....	77
9.17	Test Pattern .....	78
9.18	Reverse X.....	80
9.19	Device User ID .....	81
9.20	Device Reset .....	81
9.21	Field Upgrade.....	81
9.22	User Set Control.....	82
9.23	Sequencer Control .....	84
<b>Chapter 10. Troubleshooting.....</b>		<b>87</b>
<b>Appendix A. Defective Pixel Map Download .....</b>		<b>89</b>
<b>Appendix B. Field Upgrade.....</b>		<b>91</b>
<b>Appendix C. Index .....</b>		<b>93</b>

## Tables

Table 5-1	Specifications of VC-101MX/151MX .....	18
Table 7-1	Channel Assignments for CoaXPress Connectors .....	30
Table 7-2	Pin Configurations for Power Input Receptacle .....	31
Table 7-3	Pin Configurations for Control I/O Receptacle.....	32
Table 8-1	Minimum and Maximum Exposure Time Setting .....	47
Table 8-2	Readout Time .....	49
Table 8-3	Temporal Offset Value for the VC-101MX .....	51
Table 8-4	Temporal Offset Value for the VC-151MX .....	51
Table 9-1	XML Parameters related to ROI .....	54
Table 9-2	Minimum ROI Width and Height Settings.....	54
Table 9-3	Maximum Frame Rates by VC-101MX Vertical ROI Changes.....	55
Table 9-4	Maximum Frame Rates by VC-151MX Vertical ROI Changes.....	55
Table 9-5	XML Parameters related to Binning .....	56
Table 9-6	XML Parameters related to CXP Link Configuration.....	58
Table 9-7	XML Parameter related to Pixel Format .....	59
Table 9-8	Pixel Format Values .....	59
Table 9-9	XML Parameters related to Data ROI.....	60
Table 9-10	XML Parameters related to White Balance.....	61
Table 9-11	XML Parameter related to Balance White Auto .....	61
Table 9-12	XML Parameters related to Gain and Black Level .....	62
Table 9-13	XML Parameter related to Hot Pixel Correction .....	63
Table 9-14	XML Parameters related to Dynamic Defective Pixel Correction .....	63
Table 9-15	Calculation of Defect Pixel Correction Value .....	65
Table 9-16	XML Parameters related to Flat Field Correction.....	67



---

Table 9-17	XML Parameters related to Digital I/O Control .....	71
Table 9-18	XML Parameter related to Debounce Time .....	74
Table 9-19	XML Parameters related to Timer Control.....	75
Table 9-20	XML Parameters related to Cooling Control.....	76
Table 9-21	XML Parameters related to Device Temperature.....	77
Table 9-22	Status LED .....	77
Table 9-23	XML Parameters related to Test Pattern .....	78
Table 9-24	XML Parameter related to Reverse X.....	80
Table 9-25	XML Parameter related to Device User ID.....	81
Table 9-26	XML Parameter related to Device Reset .....	81
Table 9-27	XML Parameters related to User Set Control.....	82
Table 9-28	XML Parameters related to Sequencer Control .....	84

## Figures

Figure 5-1	Camera Block Diagram.....	19
Figure 5-2	VC-101MX-M9 Spectral Response .....	20
Figure 5-3	VC-151MX-M6 Spectral Response .....	21
Figure 5-4	VC-101MX-C9 Spectral Response .....	22
Figure 5-5	VC-151MX-C6 Spectral Response .....	23
Figure 5-6	Mechanical Dimension for VC-101MX-9 M72-mount.....	24
Figure 5-7	Mechanical Dimension for VC-151MX-6 M72-mount.....	25
Figure 7-1	VC-101MX with DIN 1.0/2.3-type Connectors .....	28
Figure 7-2	VC-151MX with DIN 1.0/2.3-type Connectors .....	29
Figure 7-3	CoaXPress DIN 1.0/2.3-type Connectors .....	30
Figure 7-4	Pin Assignments for Power Input Receptacle .....	31
Figure 7-5	Pin Assignments for Control I/O Receptacle.....	32
Figure 7-6	Trigger Input Schematic.....	33
Figure 7-7	Strobe Output Schematic .....	33
Figure 8-1	Exposure Start Triggering.....	35
Figure 8-2	Frame Acquisition with Software Trigger Signal .....	41
Figure 8-3	External Trigger Delay .....	44
Figure 8-4	Timed Exposure Mode .....	45
Figure 8-5	Trigger Overlapped with Timed Exposure Mode .....	45
Figure 8-6	Trigger Width Exposure Mode .....	46
Figure 8-7	Overlapped Exposure and Readout .....	48
Figure 8-8	Non-overlapped Exposure and Sensor Readout.....	49
Figure 8-9	Rolling Shutter Operation.....	50
Figure 9-1	Region of Interest.....	53

Figure 9-2	2 × 2 Binning .....	57
Figure 9-3	CXP Link Configuration .....	58
Figure 9-4	Effective Data ROI.....	60
Figure 9-5	Dynamic Defective Pixel Correction.....	64
Figure 9-6	Location of Defect Pixel to be corrected .....	65
Figure 9-7	Generation and Application of Flat Field Data.....	68
Figure 9-8	Bilinear Interpolated Magnification.....	68
Figure 9-9	Flat Field Data Selector.....	69
Figure 9-10	User Output .....	71
Figure 9-11	Exposure Active Signal.....	72
Figure 9-12	Strobe Signal .....	73
Figure 9-13	Debounce .....	74
Figure 9-14	Timer Signal.....	76
Figure 9-15	Grey Horizontal Ramp.....	78
Figure 9-16	Grey Diagonal Ramp .....	79
Figure 9-17	Grey Diagonal Ramp Moving.....	79
Figure 9-18	Original Image .....	80
Figure 9-19	Reverse X Image.....	80
Figure 9-20	User Set Control.....	83
Figure 9-21	Sequencer Diagram (Use Case).....	86



## Chapter 1. Precautions

### General



- Do not drop, disassemble, repair or alter the device. Doing so may damage the camera electronics and cause an electric shock.
  - Do not let children or companion animals touch the device without supervision.
  - Stop using the device and contact the nearest dealer or manufacturer for technical assistance if liquid such as water, drinks or chemicals gets into the device.
  - Do not touch the device with wet hands. Doing so may cause an electric shock.
  - Make sure that the temperature of the camera does not exceed the temperature range specified in 5.2 Specifications. Otherwise the device may be damaged by extreme temperature.
- 

### Installation and Maintenance



- Do not install in dusty or dirty areas - or near an air conditioner or heater to reduce the risk of damage to the device.
  - Avoid installing and operating in an extreme environment where vibration, heat, humidity, dust, strong magnetic fields, explosive/corrosive mists or gases are present.
  - Do not apply excessive vibration and shock to the device. This may damage the device.
  - Avoid direct exposure to a high intensity light source. This may damage the image sensor.
  - Do not install the device under unstable lighting conditions. Severe lighting change will affect the quality of the image produced by the device.
- 

### Power Supply



- Applying incorrect power can damage the camera. If the voltage applied to the camera is greater or less than the camera's nominal voltage, the camera may be damaged or operate erratically. Please refer to 5.2 Specifications for the camera's nominal voltage.
    - ※ Vieworks Co., Ltd. does NOT provide power supplies with the device.
  - Make sure the power is turned off before connecting the power cord to the camera. Otherwise damage to the camera may result.
-

## Chapter 2. Warranty

Do not open the housing of the camera. The warranty becomes void if the housing is opened. For information about the warranty, please contact your local dealer or factory representative.

## Chapter 3. Compliance & Certifications

### 3.1 FCC Compliance

This equipment has been tested and found to comply with the limits for a Class A digital device, pursuant to part 15 of the FCC Rules. These limits are designed to provide reasonable protection against harmful interference when the equipment is operated in a commercial environment. This equipment generates, uses, and can radiate radio frequency energy and, if not installed and used in accordance with the instruction manual, may cause harmful interference to radio communications. Operation of this equipment in a residential area is likely to cause harmful interference in which case the user will be required to correct the interference at his own expenses.

### 3.2 CE: DoC

EMC Directive 2014/30/EU  
EN 55032:2012 (Class A), EN 55024:2010  
Class A

### 3.3 KC

#### KCC Statement

Type	Description
Class A (Broadcasting Communication Device for Office Use)	This device obtained EMC registration for office use (Class A), and may be used in places other than home. Sellers and/or users need to take note of this.

## Chapter 4. Package Component

---

Package Component



VC-101MC <M72-mount>



VC-151MC <M72-mount>

---



## Chapter 5. Product Specifications

### 5.1 Overview

The VC-101MX and VC-151MX, the latest models of the industrial proven VC series, are new 101 and 151 megapixel CoaXPress cameras and based on the latest CMOS image sensor technology (IMX461 and IMX411) from Sony Semiconductor Solutions Corporation. The VC-101MX-9 offers up to 8.7 frames per second at 11648 × 8742 resolution. For even higher resolution applications, the VC-151MX-6 offers up to 6.2 frames per second at 14192 × 10640 resolution. Equipped with the Vieworks' innovative technologies proved by world's top FPD manufacturers, the VC-101MX and VC-151MX cameras offer not only highly uniformed images but also high speed image processing capabilities. Featured with high quality image uniformity and high resolution, these cameras are ideal for demanding applications such as FPD, PCB and semiconductor inspections.

#### Main Features

- High Speed 101 / 151 Megapixel CMOS Image Sensor
- Electronic Exposure Time Control (Rolling Shutter)
- Output Pixel Format: 8 / 10 / 12 / 14 / 16 bit
- Strobe Output
- Dynamic Defective Pixel Correction
- Output Channel: CXP-3/6 × 1 / 2 / 4
- CoaXPress Interface up to 25 Gbps using 4 coax cables
- Power Over CoaXPress (PoCXP)
- Gain / Black Level Control
- Test Pattern
- Temperature Monitor
- Field Upgrade
- DSNU and PRNU Correction
- Flat Field Correction with Sequencer Control
- Hot Pixel Correction
- GenICam Compatible – XML based Control
- VC-101MX/151MX Feature Bar



## 5.2 Specifications

The technical specifications of the VC-101MX/151MX cameras are as follows.

Specifications	VC-101MX-M/C 9 H	VC-151MX-M/C 6 H
Active Image (H × V)	11648 × 8742	14192 × 10640
Sensor	Sony IMX461	Sony IMX411
Sensor Type	Back-Illuminated CMOS Image Sensor	
Sensor Size (Diagonal)	43.80 mm × 32.87 mm (55 mm)	53.36 mm × 40.01 mm (66.7 mm)
Pixel size	3.76 μm × 3.76 μm	
Interface	CoaXPress (CXP-3 / CXP-6)	
Electronic Shutter	Rolling Shutter	
Max. Frame Rate	Overlapped: 8.7 fps	Overlapped: 6.2 fps
Pixel Data Format	8 bit / 10 bit / 12 bit / 14 bit / 16 bit	
Exposure Time	1 μs ~ 60 s (1 μs step)	
Partial Scan (Max. Speed)	679.1 fps at 2 Lines	546.4 fps at 2 Lines
Binning	Sensor	×1, ×3 (Horizontal and Vertical Dependent)
	Logic	×1, ×2, ×4 (Horizontal and Vertical Independent)
Black Level Control	0 ~ 4095 LSB at 16 bit	
Gain Control	1× ~ 32×	
Trigger	Overlapped	Free-Run
Synchronization	Non-overlapped	Hardware Trigger, Software Trigger or CXP
External Trigger	3.3 V ~ 24.0 V Logical level input, Optically isolated	
Software Trigger	Asynchronous, Programmable via Camera API	
Dynamic Range	78 dB	
Lens Mount	M72-mount	
Power	External	11 ~ 24 V DC
	Dissipation	Typ. 15.5 W
Environmental	Operating: 0 ~ 40°C, Storage: -40°C ~ 70°C	
Dimension / Weight	90mm × 90mm × 92.5mm, 800g (with M72-mount)	100mm × 100mm × 92.5mm, 1070g (with M72-mount)
API SDK	Vieworks Imaging Solution 7.X	

Table 5-1 Specifications of VC-101MX/151MX

### 5.3 Camera Block Diagram

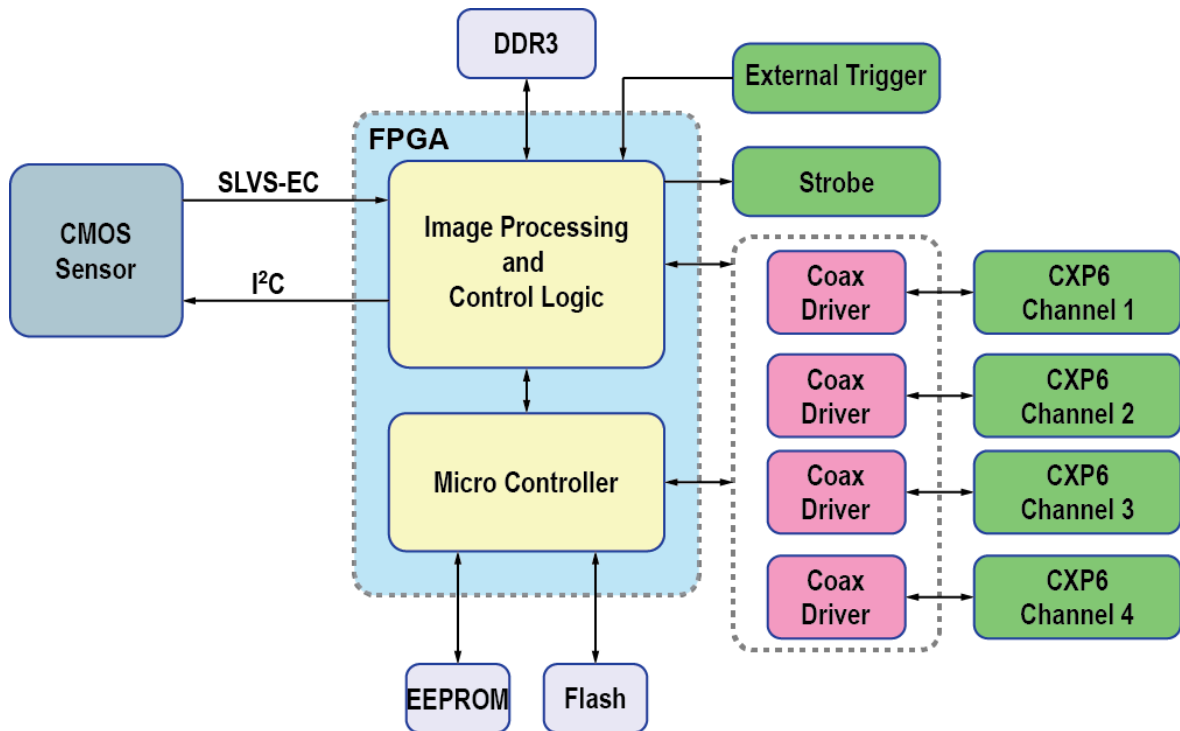

Figure 5-1 Camera Block Diagram

All controls and data processing of the VC-101MX/151MX cameras are carried out in one FPGA chip. The FPGA generally consists of a 32-bit RISC Micro-Controller and Processing & Control logic. The Micro-Controller receives commands from the user through the CoaXPress interface and then processes them. The Processing & Control logic processes the image data received from the CMOS image sensor and then transmits data through the CoaXPress interface. The Processing & Control logic also controls the trigger inputs and strobe outputs, which are sensitive to time. Furthermore, Flash and DDR3 are installed outside FPGA. The DDR3 is used for the frame buffer to process images and the Flash stores the firmware to operate the Micro-Controller.

## 5.4 Spectral Response

### 5.4.1 Monochrome Spectral Response

The following graph shows the spectral response of the VC-101MX monochrome camera.

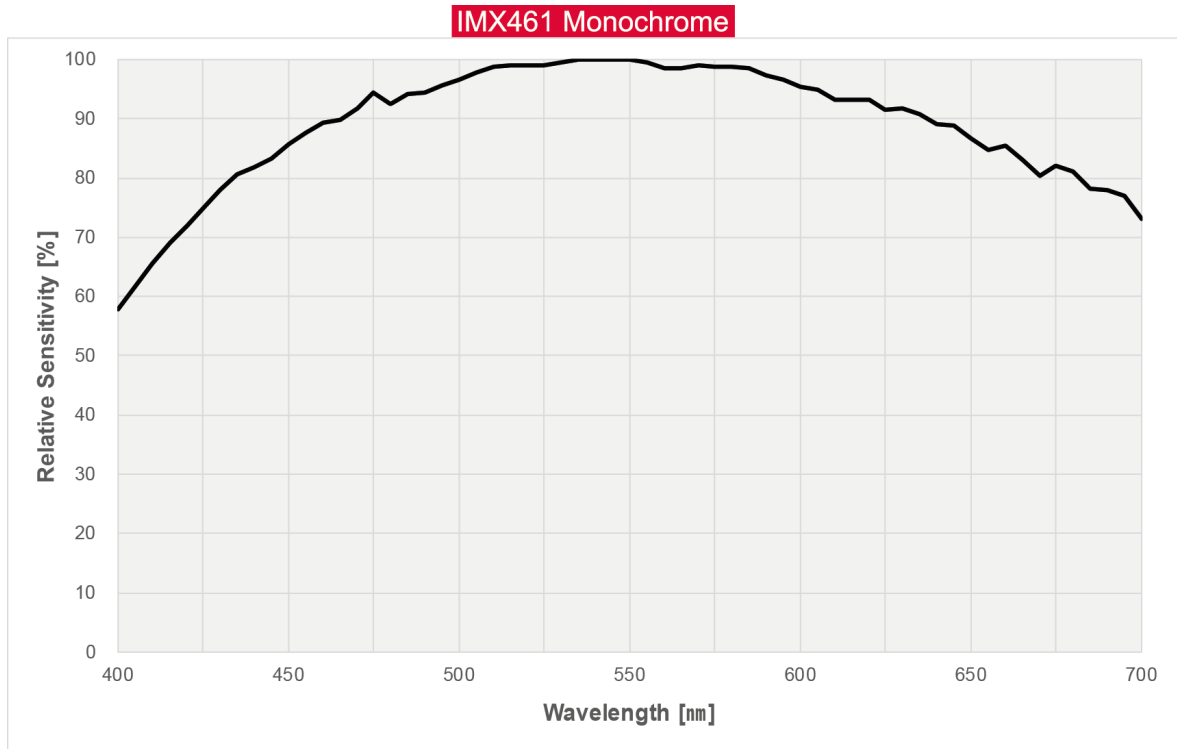

Figure 5-2 VC-101MX-M9 Spectral Response

The following graph shows the spectral response of the VC-151MX monochrome camera.

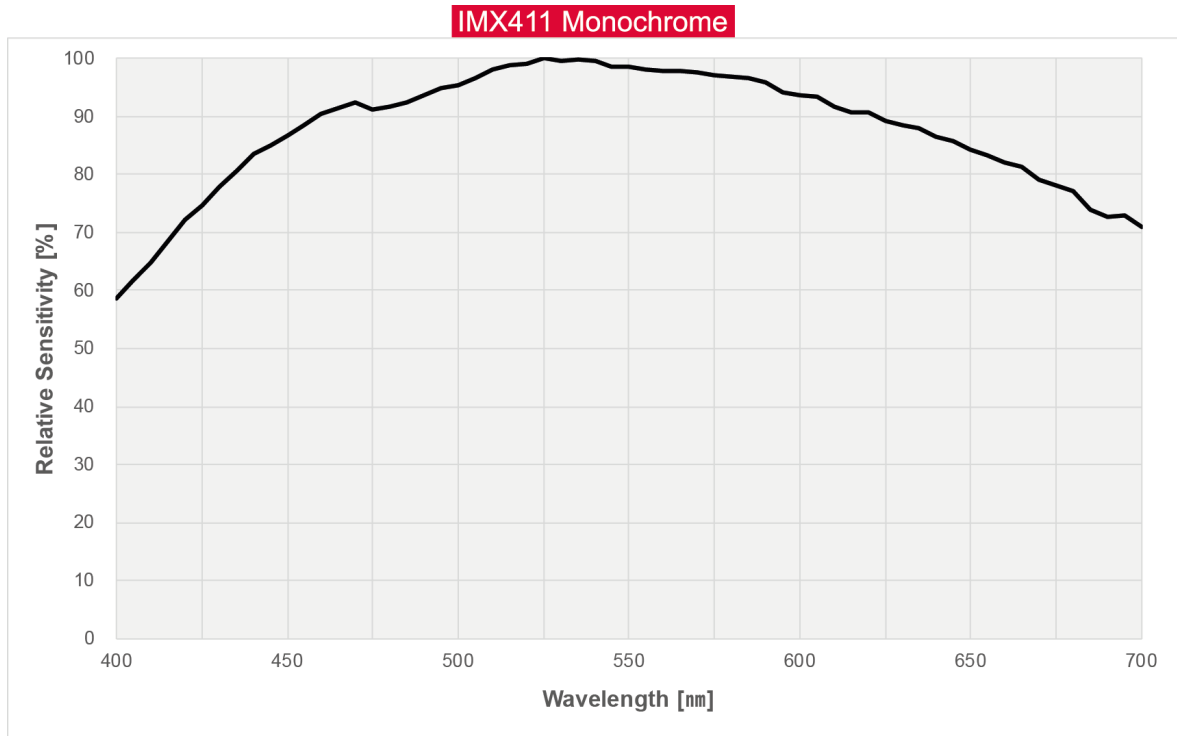

Figure 5-3 VC-151MX-M6 Spectral Response

### 5.4.2 Color Spectral Response

The following graph shows the spectral response of the VC-101MX color camera.

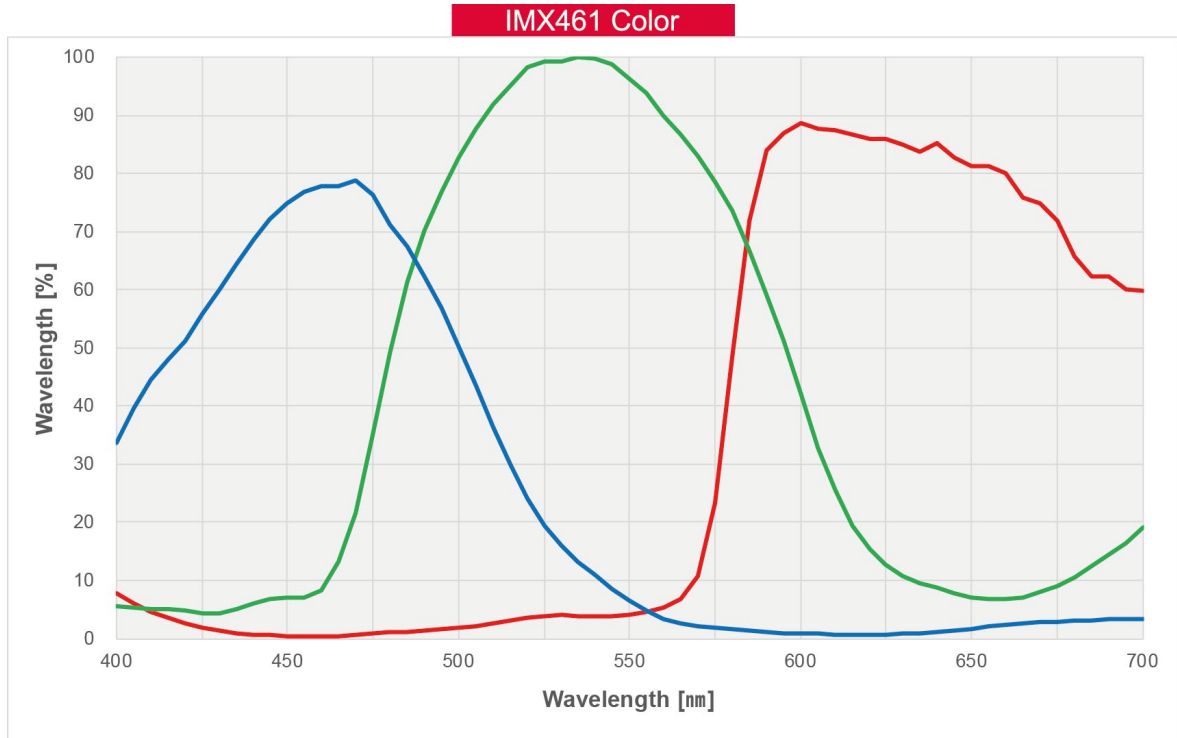

Figure 5-4 VC-101MX-C9 Spectral Response

The following graph shows the spectral response of the VC-151MX color camera.

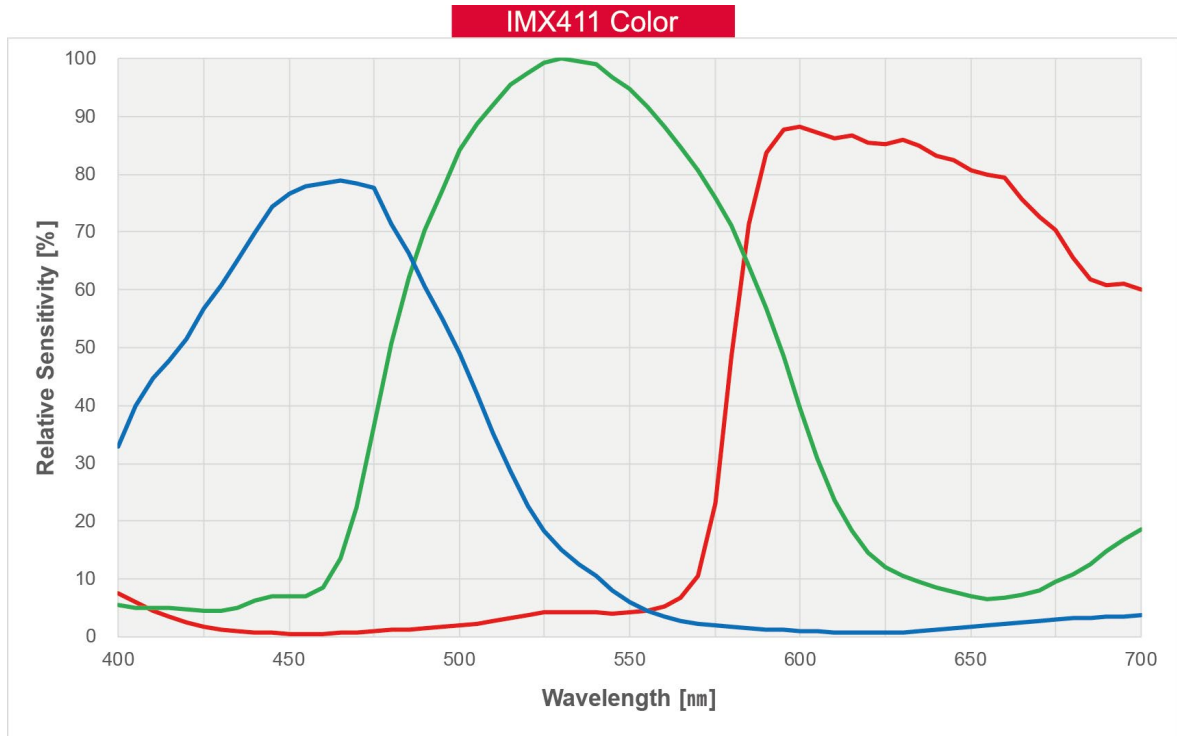

Figure 5-5 VC-151MX-C6 Spectral Response

### 5.5 Mechanical Specification

The camera dimensions in millimeters are shown in the following figures.

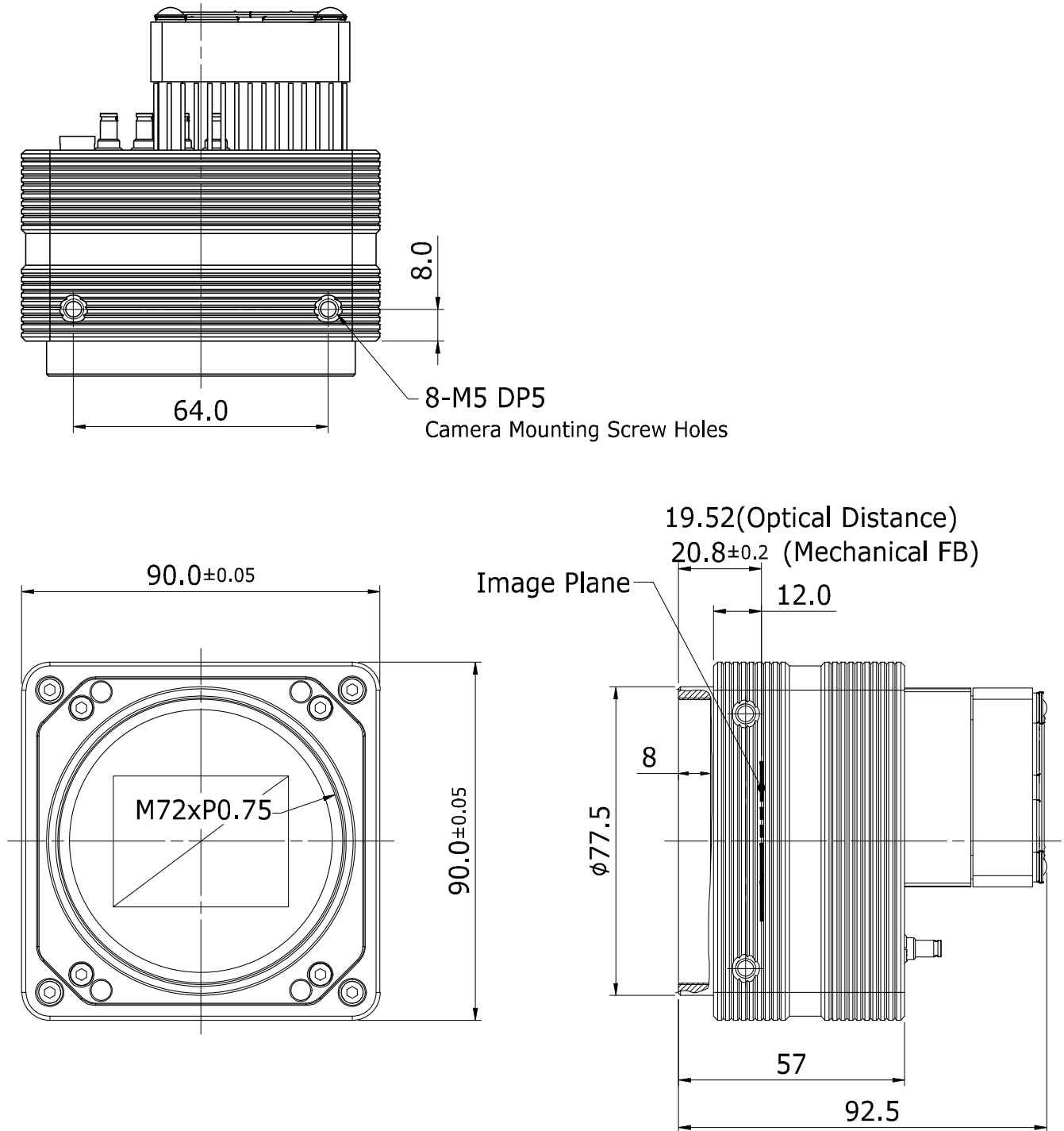

Figure 5-6 Mechanical Dimension for VC-101MX-9 M72-mount



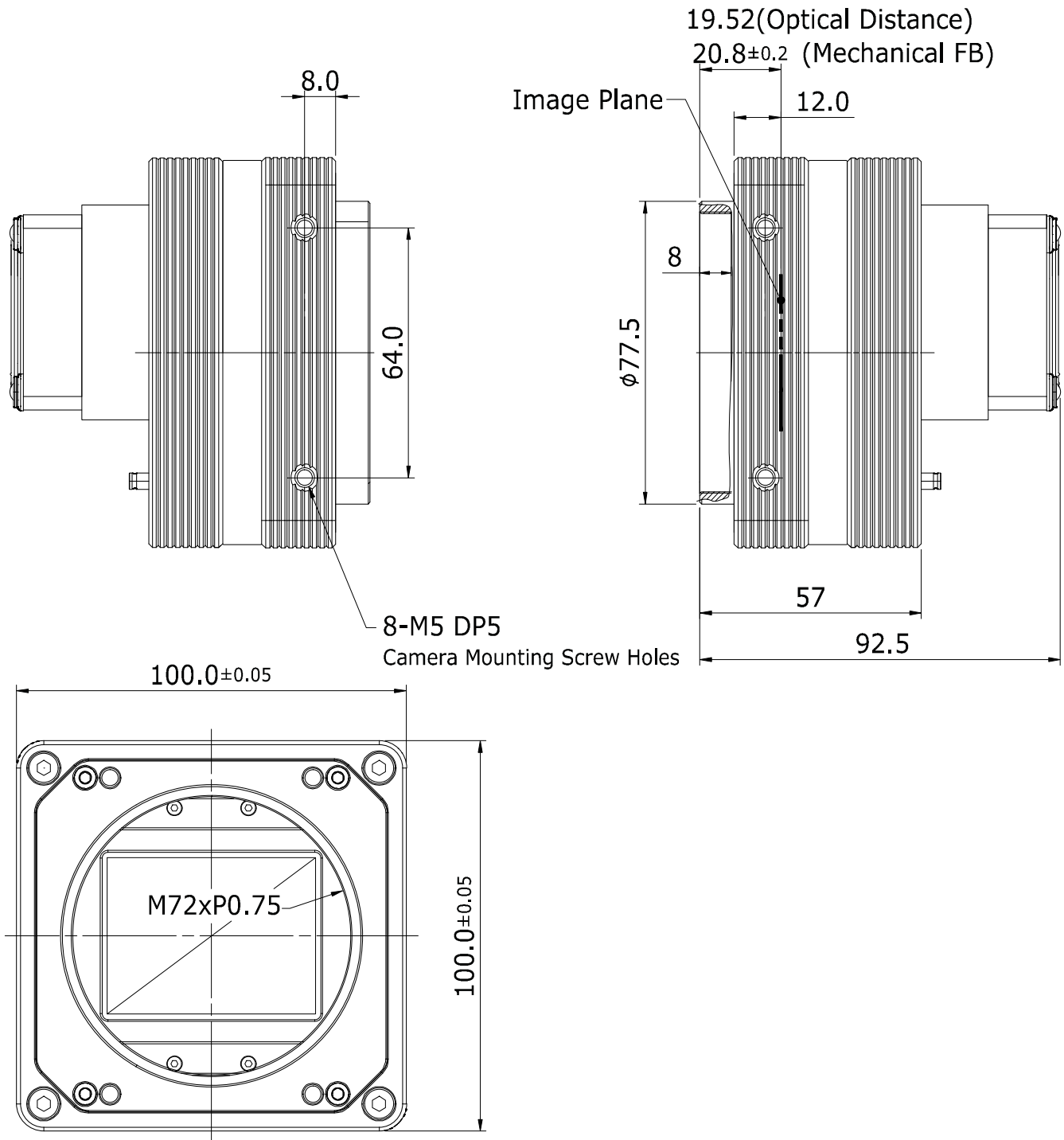

Figure 5-7 Mechanical Dimension for VC-151MX-6 M72-mount

## Chapter 6. Connecting the Camera

The following instructions assume that you have installed a CoaXPress Frame Grabber (hereinafter 'CXP Frame Grabber') in your computer including related software. Procedures below also assume that you may attempt to configure a link between a camera and CXP Frame Grabber by using four coax cables. For more detailed information, refer to your CXP Frame Grabber User Manual.

To connect the camera to your computer, follow the steps below:

1. Make sure that the power supply is not connected to the camera and your computer is turned off.
  - Go on to step 2 if you are using a power supply.
  - Go on to step 3 if you are using a Power over CoaXPress (PoCXP) Frame Grabber.
2. If you are using a power supply:
  - a. Plug one end of a coax cable into the CH1 of the CXP connector on the camera and the other end of the coax cable into the CH1 of the CXP Frame Grabber in your computer. Then, connect the CH2, CH3 and CH4 of the CXP connector on the camera to the CH2, CH3 and CH4 of the CXP Frame Grabber respectively using the other three coax cables.
  - b. Connect the plug of the power adapter to the 6-pin power input receptacle on the camera.
  - c. Plug the power adapter into a working electrical outlet.
3. If you are using a PoCXP Frame Grabber:
  - a. Plug one end of a coax cable into the CH1 of the CXP connector on the camera and the other end of the coax cable into the CH1 of the CXP Frame Grabber in your computer. Then, connect the CH2, CH3, and CH4 of the CXP connector on the camera to the CH2, CH3 and CH4 of the CXP Frame Grabber respectively using the other three coax cables.
  - b. You must connect both the CH1 and CH2 channels to power the camera via PoCXP.
4. Verify all the cable connections are secure.

## 6.1 Precaution to Center the Image Sensor

- Users do not need to center the image sensor as it is adjusted as factory default settings.
- When you need to adjust the center of the image sensor, please contact your local dealer or the manufacturer for technical assistance.

## 6.2 Precaution about Blurring Compared to the Center

- Users do not need to adjust the tilt as it is adjusted as factory default settings.
- If the tilt settings need to be adjusted inevitably, please contact your local dealer or factory representative for technical support.

## 6.3 Installing Vieworks Imaging Solution

You can download the Vieworks Imaging Solution at <http://vision.vieworks.com>. You should perform the software installation first and then the hardware installation.

## Chapter 7. Camera Interface

### 7.1 General Description

As shown in the following figure, three types of connectors and an LED indicator are located on the back of the camera and have the functions as follows:

- ① Status LED: displays power status and operation mode.
- ② 6 pin Power Input Receptacle: supplies power to the camera.
- ③ 4 pin Control I/O Receptacle: inputs external trigger signals and outputs strobe signals.
- ④ CoaXPress Connector: transmits video data and controls the camera.

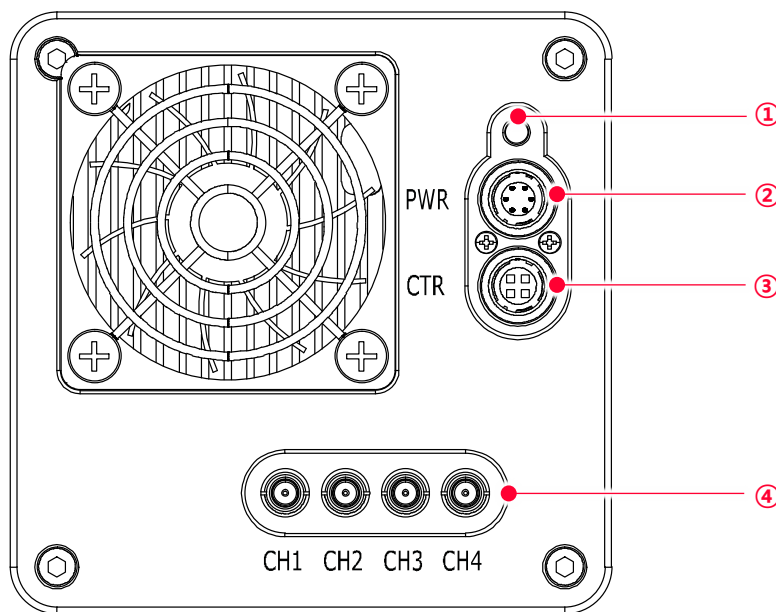

Figure 7-1 VC-101MX with DIN 1.0/2.3-type Connectors

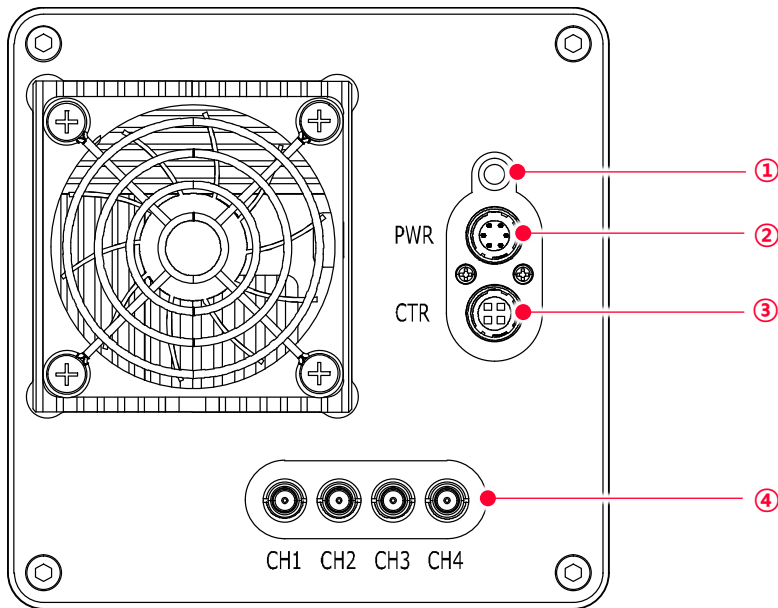

Figure 7-2 VC-151MX with DIN 1.0/2.3-type Connectors

## 7.2 CoaXPress Connector

CoaXPress protocol includes an automatic link detection mechanism (Plug and Play) to correctly detect the camera to the CXP Frame Grabber connection. The connection between the camera and CXP Frame Grabber uses a coax (also known as 'coaxial') cable and provides up to 6.25 Gbps bit rate per cable. The VC-101MX/151MX cameras can be powered over the cable if you are using a PoCXP enabled Frame Grabber.

### 7.2.1 CoaXPress Connector (75 $\Omega$ DIN 1.0/2.3 Receptacle)

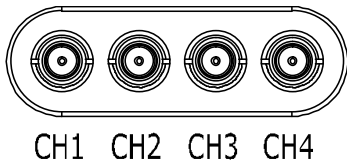

Figure 7-3 CoaXPress DIN 1.0/2.3-type Connectors

The CoaXPress connectors on the VC-101MX/151MX cameras comply with the CoaXPress standard and the following table shows the channel assignments.

Channel	Max. Bit Rate per Coax	Type	PoCXP Compliant
CH1	6.25 Gbps	Master Connection	Yes
CH2	6.25 Gbps	Extension Connection	Yes
CH3	6.25 Gbps	Extension Connection	No
CH4	6.25 Gbps	Extension Connection	No

Table 7-1 Channel Assignments for CoaXPress Connectors



#### Caution!

When you connect a camera to a CXP Frame Grabber using coax cables, make sure to connect the cables to their correct channels. If you connect the CH1 of the CXP connector on the camera to a channel other than CH1 of the CXP Frame Grabber, the camera may not transmit images properly or the communication between the computer and camera may fail.

### 7.3 Power Input Receptacle

The power input receptacle is a Hirose 6 pin connector (part # HR10A-7R-6PB). The pin assignments and configurations are as follows:

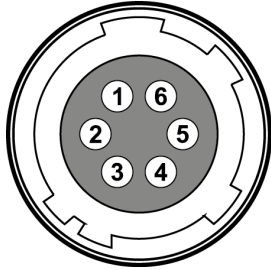

Figure 7-4 Pin Assignments for Power Input Receptacle

Pin Number	Signal	Type	Description
1, 2, 3	+12V DC	Input	DC Power Input
4, 5, 6	DC Ground	Input	DC Ground

Table 7-2 Pin Configurations for Power Input Receptacle



**Note:**

- A recommended mating connector for the Hirose 6 pin connector is the Hirose 6 pin plug (part # HR10A-7P-6S) or the equivalent.
- It is recommended that you use the power adapter, which has at least 3 A current output at 11 ~ 24 V voltage output (You need to purchase a power adapter separately.).

#### Precaution for Power Input



**Caution!**

- Make sure the power is turned off before connecting the power cord to the camera. Otherwise, damage to the camera may result.
- If the voltage applied to the camera is greater than specified in the specifications, damage to the camera may result.

## 7.4 Control I/O Receptacle

The Control I/O Receptacle is a Hirose 4 pin connector (part # HR10A-7R-4S) and consists of an external trigger signal input and strobe output ports. The pin assignments and configurations are as follows:

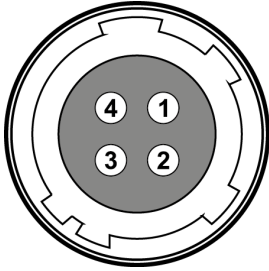

Figure 7-5 Pin Assignments for Control I/O Receptacle

Pin Number	Signal	Type	Description
1	Trigger Input +	Input	3.3 V ~ 24.0 V TTL input
2	Trigger Input -	Input	-
3	DC Ground	-	DC Ground
4	Line 1 Output	Output	3.3 V TTL Output Output resistance: 47 $\Omega$

Table 7-3 Pin Configurations for Control I/O Receptacle



**Note:**

A recommended mating connector for the Hirose 4-pin connector is the Hirose 4-pin plug (part # HR10A-7P-4P) or the equivalent.



### 7.5 Trigger Input Circuit

The following figure shows trigger signal input circuit of the 4 pin connector. Transmitted trigger signal is applied to the internal circuit through a photo coupler. With the Debounce feature, you can specify the width of input signal to be considered as a valid input signal. An external trigger circuit example is shown below.

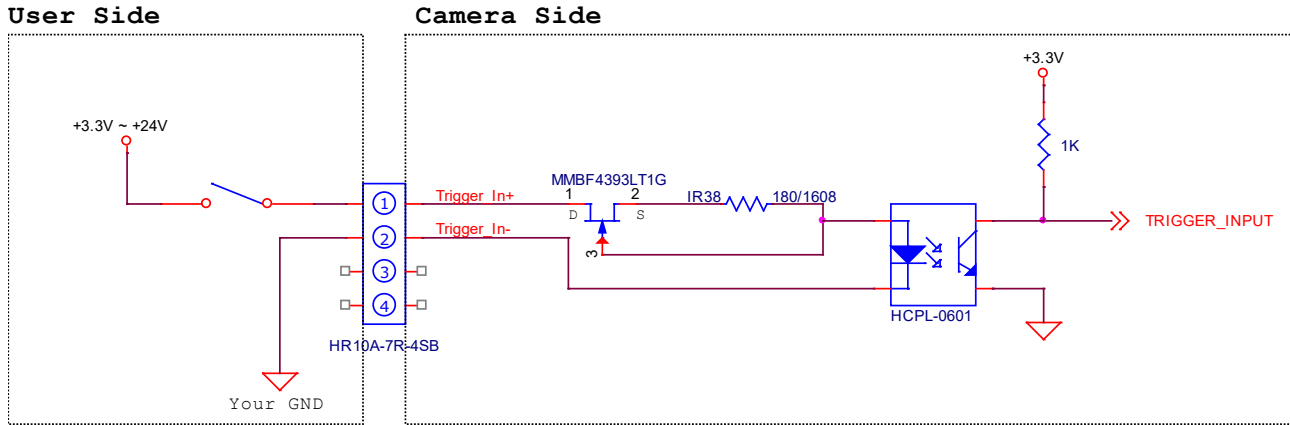

Figure 7-6 Trigger Input Schematic

### 7.6 Strobe Output Circuit

The strobe output signal comes out through a 3.3 V output level of TTL Driver IC. A pulse width of signal is synchronized with an exposure (shutter) signal of the camera.

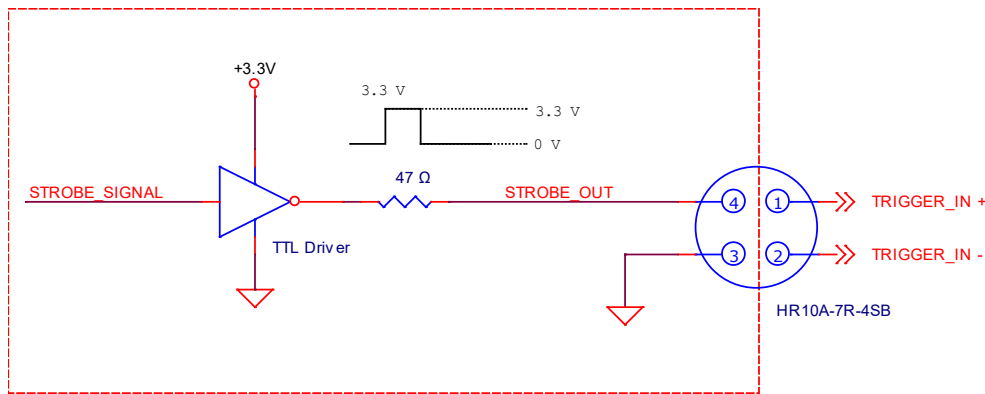

Figure 7-7 Strobe Output Schematic

## Chapter 8. Acquisition Control

This chapter provides detailed information about controlling image acquisition.

- Triggering image acquisition.
- Setting the exposure time
- Controlling the camera's image acquisition rate
- Variation of the camera's maximum allowed image acquisition rate according to the camera settings

### 8.1 Overview

This section presents an overview of the elements involved with controlling the acquisition of images.

Three major elements are involved in controlling the acquisition of images:

- Acquisition Start and Acquisition Stop commands and Acquisition Mode parameter
- Exposure start trigger
- Exposure time control



**Note:**

When reading the explanations in the overview and in this entire chapter, keep in mind that the term frame is typically used to mean a single acquired image.

---

#### Acquisition Start and Stop Commands and Acquisition Mode

The **Acquisition Start** command prepares the camera to acquire frames. The camera cannot acquire frames unless an **Acquisition Start** command has first been executed.

A parameter called the **Acquisition Mode** has a direct bearing on how the **Acquisition Start** command operates. The VC-101MX/151MX cameras only support **Continuous** for the **Acquisition Mode** parameter. If the **Acquisition Mode** parameter is set to **Continuous**, an **Acquisition Start** command does not expire after a single frame is acquired. Once an **Acquisition Start** command has been executed, you can acquire as many frames as you like. The **Acquisition Start** command will remain in effect until you execute an **Acquisition Stop** command. Once an **Acquisition Stop** command has been executed, the camera will not be able to acquire frames until a new **Acquisition Start** command is executed.

## Exposure Start Trigger

Applying an exposure start trigger signal to the camera will exit the camera from the *waiting for exposure start trigger* acquisition status and will begin the process of exposing and reading out a frame (see Figure 8-1).

As soon as the camera is ready to accept another exposure start trigger signal, it will return to the *waiting for exposure start trigger* acquisition status. A new exposure start trigger signal can then be applied to the camera to begin another frame exposure. The exposure start trigger has two modes: off and on.

If the **Trigger Mode** parameter is set to **Off**, the camera will generate all required exposure start trigger signals internally, and you do not need to apply exposure start trigger signals to the camera. The rate at which the camera will generate the signals and acquire frames will be determined by the way that you set several frame rate related parameters.

If the **Trigger Mode** parameter is set to **On**, you must trigger exposure start by applying exposure start trigger signals to the camera. Each time a trigger signal is applied, the camera will begin a frame exposure. When exposure start is being triggered in this manner, it is important that you do not attempt to trigger frames at a rate that is greater than the maximum allowed (There is a detailed explanation about the maximum allowed frame rate at the end of this chapter.). Exposure start trigger signals applied to the camera when it is not in a *waiting for exposure start trigger* acquisition status will be ignored.

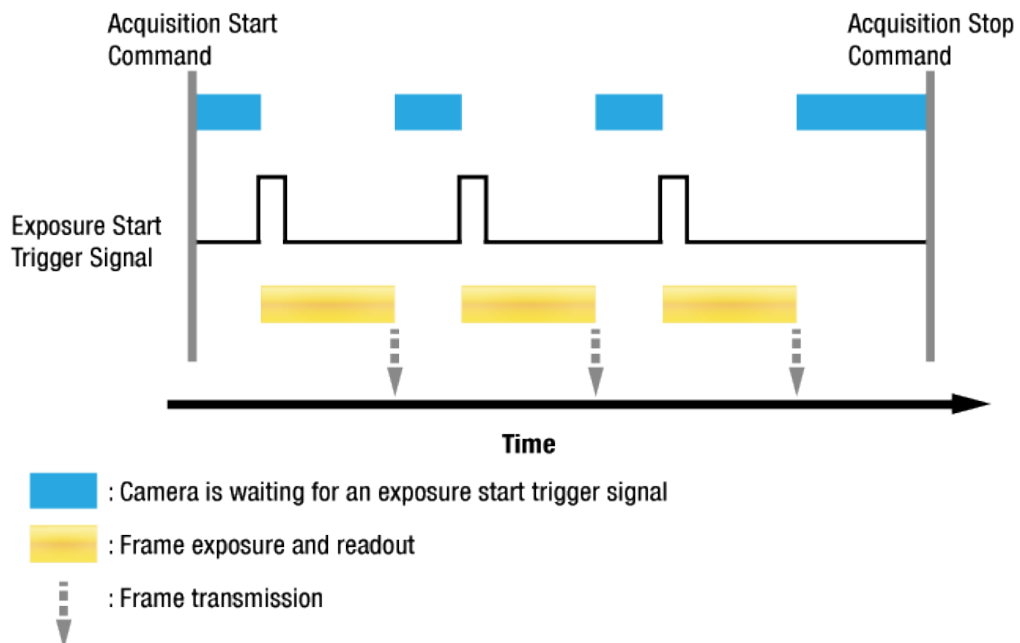

Figure 8-1 Exposure Start Triggering

## Applying Trigger Signals

The paragraphs above mention “applying a trigger signal”. There are four ways to apply an exposure start trigger signal to the camera: via **Software**, via **User Output0**, via **CXPin** or via **Line0** (commonly referred to a hardware).

To apply trigger signals via **Software**, you must set the **Trigger Source** parameter to **Software**. At that point, each time a **Trigger Software** command is executed, the exposure start trigger signal will be applied to the camera.

To apply trigger signals via **User Output0**, you must set the **Trigger Source** parameter to **User Output0**. At that point, you can apply an exposure start trigger signal to the camera by switching the **User Output Value** parameter between **On** (rise) and **Off** (fall).

To apply trigger signals via CH1 of the CXP Frame Grabber, you must set the **Trigger Source** parameter to **CXPin**. At that point, each time a proper CoaXPress trigger signal is applied to the camera by using the APIs provided by a CXP Frame Grabber manufacturer, the exposure start trigger signal will be applied to the camera. For more information, refer to your CXP Frame Grabber User Manual.

To apply trigger signals via hardware (external), you must set the **Trigger Source** parameter to **Line0**. At that point, each time a proper electrical signal is applied to the camera, an occurrence of the exposure start trigger signal will be recognized by the camera.

## Exposure Time Control

When an exposure start trigger signal is applied to the camera, the camera will begin to acquire a frame.

A critical aspect of frame acquisition is how long the pixels in the camera’s sensor will be exposed to light during the frame acquisition.

If the **Trigger Source** parameter is set to **Software**, the **Exposure Time** parameter will determine the exposure time for each frame.

If the **Trigger Source** parameter is set to **User Output0**, **CXPin** or **Line0**, there are two modes of operation: **Timed** and **Trigger Width**.

With the **Timed** mode, the **Exposure Time** parameter will determine the exposure time for each frame.

With the **Trigger Width** mode, the way that you manipulate the rise and fall of the User Output, CoaXPress or hardware (external) signal will determine the exposure time. The **Trigger Width** mode is especially useful if you want to change the exposure time from frame to frame.

## 8.2 Acquisition Start/Stop Commands and Acquisition Mode

Executing an **Acquisition Start** command prepares the camera to acquire frames. You must execute an **Acquisition Start** command before you can begin acquiring frames.

Executing an **Acquisition Stop** command terminates the camera's ability to acquire frames.

When the camera receives an **Acquisition Stop** command:

- If the camera is not in the process of acquiring a frame, its ability to acquire frames will be terminated immediately.
- If the camera is in the process of acquiring a frame, the frame acquisition process will be allowed to finish and the camera's ability to acquire new frames will be terminated.



**Note:**

When you execute the **Acquisition Start** command while the previous frame acquisition process is still in progress, the command will be ignored. To avoid this, you must wait a minimum readout time (refer to Table 8-2) after the execution of the **Acquisition Stop** command. Then, you can safely execute the **Acquisition Start** command again.

---

The VC-101MX/151MX cameras only provides the **Continuous** mode of operation for the **Acquisition Mode**.

After an **Acquisition Start** command has been executed, exposure start can be triggered as desired. Each time an exposure start trigger is applied while the camera is in a *waiting for exposure start trigger* acquisition status, the camera will acquire and transmit a frame. The camera will retain the ability to acquire frames until an **Acquisition Stop** command is executed. Once the **Acquisition Stop** command is received, the camera will no longer be able to acquire frames.

## 8.3 Exposure Start Trigger

The **Trigger Selector** parameter is used to select a type of trigger and only the Exposure Start trigger is available on the VC-101MX/151MX cameras. The Exposure Start trigger is used to begin frame acquisition. Exposure start trigger signals can be generated within the camera or may be applied externally by setting the **Trigger Source** parameter to **Software**, **User Output0**, **CXPIn** or **Line0**. If an exposure start trigger signal is applied to the camera, the camera will begin to expose a frame.

### 8.3.1 Trigger Mode

The main parameter associated with the exposure start trigger is the **Trigger Mode** parameter. The **Trigger Mode** parameter for the exposure start trigger has two available settings: **Off** and **On**.

#### Trigger Mode = Off

When the **Trigger Mode** parameter is set to **Off**, the camera will generate all required exposure start trigger signals internally, and you do not need to apply exposure start trigger signals to the camera.

If the **Trigger Mode** parameter is set to **Off**, the camera will automatically begin generating exposure start trigger signals when it receives an **Acquisition Start** command. The camera will continue to generate exposure start trigger signals until it receives an **Acquisition Stop** command.



#### Free-Run

When you set the **Trigger Mode** parameter to **Off**, the camera will generate all required trigger signals internally. When the camera is set this way, it will constantly acquire images without any need for triggering by the user. This use case commonly referred as "free run".

---

The rate at which the exposure start trigger signals are generated may be determined by the camera's **Acquisition Frame Rate** parameter.

- If the parameter is set to a value less than the maximum allowed frame rate with the current camera settings, the camera will generate exposure start trigger signals at the rate specified by the parameter setting.
- If the parameter is set to a value greater than the maximum allowed frame rate with the current camera settings, the camera will generate exposure start trigger signals at the maximum allowed frame rate.

### Exposure Time Control with Trigger Mode = Off

When the **Trigger Mode** parameter is set to **Off**, the exposure time for each frame acquisition is determined by the value of the camera's **Exposure Time** parameter. For more information about the **Exposure Time** parameter, see [8.4 Setting the Exposure Time](#).

### Trigger Mode = On

When the **Trigger Mode** parameter is set to **On**, you must apply an exposure start trigger signal to the camera each time you want to begin a frame acquisition. The **Trigger Source** parameter specifies the source signal that will act as the exposure start trigger signal.

The available settings for the **Trigger Source** parameter are:

- **Software:** You can apply an exposure start trigger signal to the camera by executing a **Trigger Software** command for the exposure start trigger on your computer.
- **User Output0:** You can apply an exposure start trigger signal to the camera by switching the **User Output Value** parameter between **On** and **Off** on your computer.
- **CXPin:** You can apply an exposure start trigger signal via **CH1** of the **CXP Frame Grabber**. For more information, refer to your **CXP Frame Grabber User Manual**.
- **Line0:** You can apply an exposure start trigger signal to the camera by injecting an externally generated electrical signal (commonly referred to as a hardware or external trigger signal) into the **Control I/O** receptacle on the camera. Refer to [7.5 Trigger Input Circuit](#) for more information.
- **Timer0Active:** You can apply an exposure start trigger signal to the camera using a user defined **Timer** signal. When you set the **Timer Trigger Source** parameter to **Line0** in the **Counter And Timer Control** category, you can specify a delay for the **Line0** signal by using the **Timer Delay** parameter. For more information, refer to [9.13 Timer Control](#).

You must also set the **Trigger Activation** parameter after setting the **Trigger Source** parameter.

The available settings for the **Trigger Activation** parameter are:

- **Falling Edge:** Specifies that a falling edge of the electrical signal will act as the exposure start trigger.
- **Rising Edge:** Specifies that a rising edge of the electrical signal will act as the exposure start trigger.

### Exposure Time Control with Trigger Mode = On

When the **Trigger Mode** parameter is set to **On** and the **Trigger Source** parameter is set to **Software**, the exposure time for each frame acquisition is determined by the value of the camera's **Exposure Time** parameter.

When the **Trigger Mode** parameter is set to **On** and the **Trigger Source** parameter is set to **CXPin** or **Line0**, the exposure time for each frame acquisition will be determined by the **Exposure Mode** parameter settings as follows:

- **Exposure Mode = Timed:** Exposure time can be controlled with the **Exposure Time** parameter.
- **Exposure Mode = Trigger Width:** Exposure time can be controlled by manipulating the external trigger signal.

When the **Trigger Mode** parameter is set to **On** and the **Trigger Source** parameter is set to **User Output0**, the exposure time for each frame acquisition will be determined by the **Exposure Mode** parameter settings as follows:

- **Exposure Mode = Timed:** Exposure time can be controlled with the **Exposure Time** parameter.
- **Exposure Mode = Trigger Width:** Exposure time can be controlled by switching the **User Output Value** parameter between **On** and **Off**.



### 8.3.2 Using a Software Trigger Signal

If the **Trigger Mode** parameter is set to **On** and the **Trigger Source** parameter is set to **Software**, you must apply a software trigger signal (exposure start) to the camera to begin each frame acquisition. Assuming that the camera is in a waiting for exposure start trigger acquisition status, frame exposure will start when the software trigger signal is received by the camera. Figure 8-2 illustrates frame acquisition with a software trigger signal.

When the camera receives a software trigger signal and begins exposure, it will exit the *waiting for exposure start trigger* acquisition status because at that point, it cannot react to a new exposure start trigger signal.

As soon as the camera is capable of reacting to a new exposure start trigger signal, it will automatically return to the waiting for exposure start trigger acquisition status.

The exposure time for each acquired frame will be determined by the value of the camera's **Exposure Time** parameter.

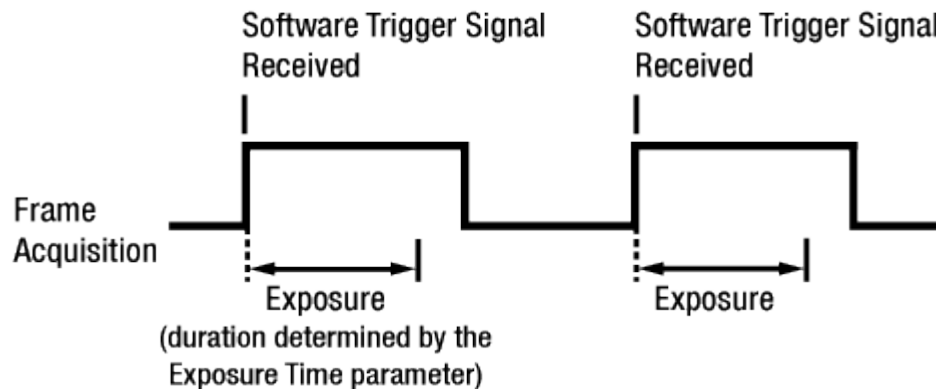

Figure 8-2 Frame Acquisition with Software Trigger Signal

When you are using a software trigger signal to start each frame acquisition, the frame rate will be determined by how often you apply a software trigger signal to the camera, and you should not attempt to trigger frame acquisition at a rate that exceeds the maximum allowed for the current camera settings (There is a detailed explanation about the maximum allowed frame rate at the end of this chapter.). Software trigger signals that are applied to the camera when it is not ready to receive them will be ignored.

### 8.3.3 Using a CoaXPress Trigger Signal

If the **Trigger Mode** parameter is set to **On** and the **Trigger Source** parameter is set to **CXPIn**, you must apply a CoaXPress trigger signal to the camera to begin each frame acquisition. A CoaXPress trigger signal will acts as the exposure start trigger signal for the camera. For more information, refer to your CXP Frame Grabber User Manual.

A rising edge or a falling edge of the CoaXPress signal can be used to trigger frame acquisition. The **Trigger Activation** parameter is used to select rising edge or falling edge triggering.

Assuming that the camera is in a *waiting for exposure start trigger* acquisition status, frame acquisition will start whenever the appropriate edge transition is received by the camera.

When the camera receives a CoaXPress trigger signal and begins exposure, it will exit the *waiting for exposure start trigger* acquisition status because at that point, it cannot react to a new exposure start trigger signal.

As soon as the camera is capable of reacting to a new exposure start trigger signal, it will automatically return to the *waiting for exposure start trigger* acquisition status.

When the camera is operating under control of a CoaXPress signal, the period of the CoaXPress trigger signal will determine the rate at which the camera is acquiring frames:

$$\frac{1}{\text{CoaXPress signal period in seconds}} = \text{Frame Rate}$$

For example, if you are operating a camera with a CoaXPress trigger signal period of 500 ms (0.5 s):

So in this case, the frame rate is 2 fps.

### 8.3.4 Using an External Trigger Signal

If the **Trigger Mode** parameter is set to **On** and the **Trigger Source** parameter is set to **Line0**, an externally generated electrical signal injected into the Control I/O Receptacle will act as the exposure start trigger signal for the camera. This type of trigger signal is generally referred to as a hardware trigger signal.

A rising edge or a falling edge of the external signal can be used to trigger frame acquisition. The **Trigger Activation** parameter is used to select rising edge or falling edge triggering.

Assuming that the camera is in a *waiting for exposure start trigger* acquisition status, frame acquisition will start whenever the appropriate edge transition is received by the camera.

When the camera receives an external trigger signal and begins exposure, it will exit the *waiting for exposure start trigger* acquisition status because at that point, it cannot react to a new exposure start trigger signal.

As soon as the camera is capable of reacting to a new exposure start trigger signal, it will automatically return to the *waiting for exposure start trigger* acquisition status.

When the camera is operating under control of an external signal, the period of the external trigger signal will determine the rate at which the camera is acquiring frames:

$$\frac{1}{\text{External signal period in seconds}} = \text{Frame Rate}$$

For example, if you are operating a camera with an External trigger signal period of 500ms (0.5 s):

So in this case, the frame rate is 2 fps.

## External Trigger Delay

When you set the Trigger Source parameter to `Timer0Active`, you can specify a delay between the receipt of a hardware trigger signal and when the trigger becomes effective.

1. Set the Timer Trigger Source parameter in the Counter And Timer Control category to `Line0`.
2. Set the Timer Delay parameter to the desired Timer delay in microseconds.
3. Set the Trigger Source parameter in the Acquisition Control category to `Timer0Active`.
4. Execute the `Acquisition Start` command and inject an externally generated electrical signal into the Control I/O Receptacle. Then, the delay set by the Timer Delay parameter expires and the exposure for image acquisition begins.

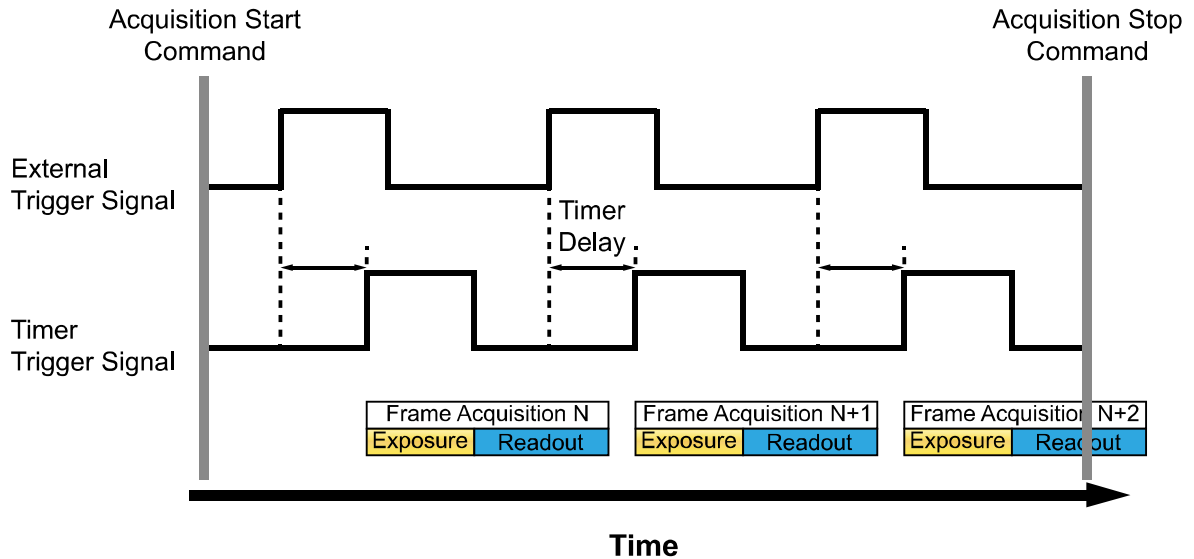

Figure 8-3 External Trigger Delay

### 8.3.5 Exposure Mode

If you are triggering the start of frame acquisition with an externally (CoaXPress or External) generated trigger signal, two exposure modes are available: Timed and Trigger Width.

#### Timed Exposure Mode

When the Timed mode is selected, the exposure time for each frame acquisition is determined by the value of the camera's Exposure Time parameter. If the camera is set for rising edge triggering, the exposure time starts when the external trigger signal rises. If the camera is set for falling edge triggering, the exposure time starts when the external trigger signal falls. The following figure illustrates Timed exposure with the camera set for rising edge triggering.

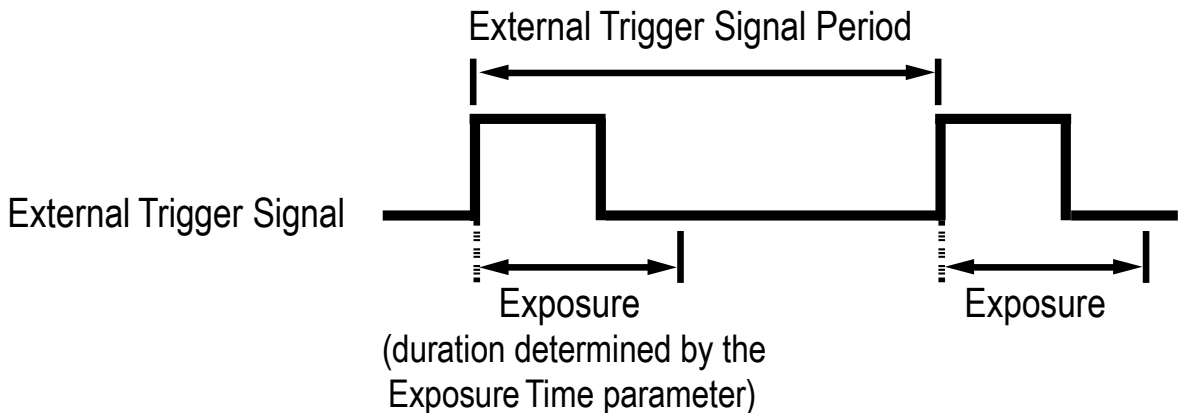

Figure 8-4 Timed Exposure Mode

Note that if you attempt to trigger a new exposure start while the previous exposure is still in progress, the trigger signal will be ignored.

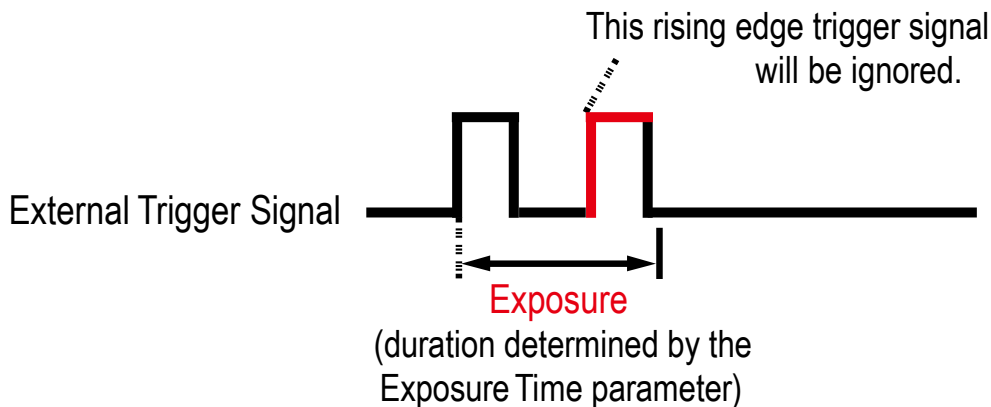

Figure 8-5 Trigger Overlapped with Timed Exposure Mode

### Trigger Width Exposure Mode

When the **Trigger Width** exposure mode is selected, the length of the exposure for each frame acquisition will be directly controlled by the external trigger signal (CoaXPress or External). If the camera is set for rising edge triggering, the exposure time begins when the external trigger signal rises and continues until the external trigger signal falls. If the camera is set for falling edge triggering, the exposure time begins when the external trigger signal falls and continues until the external trigger signal rises. The following figure illustrates **Trigger Width** exposure with the camera set for rising edge triggering.

**Trigger Width** exposure is especially useful if you intend to vary the length of the exposure time for each frame.

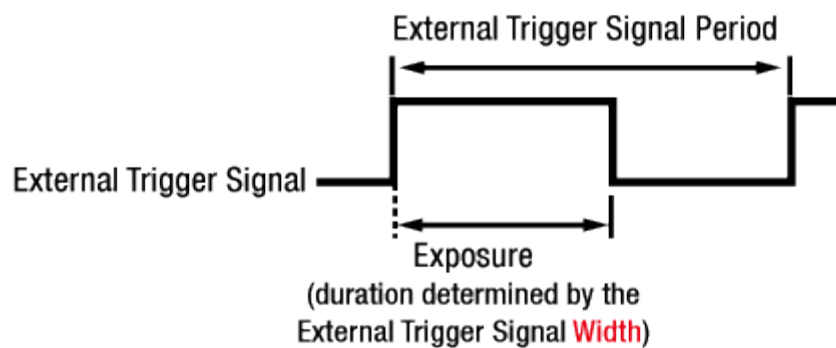

Figure 8-6 Trigger Width Exposure Mode

## 8.4 Setting the Exposure Time

This section describes how the exposure time can be adjusted manually by setting the value of the Exposure Time parameter. If you are operating the camera in any one of the following ways, you must specify an exposure time by setting the camera's Exposure Time parameter.

- the Trigger Mode is set to Off.
- the Trigger Mode is set to On and the Trigger Source is set to Software.
- the Trigger Mode is set to On, the Trigger Source is set to CXPin or Line0, and the Exposure Mode is set to Timed.

The Exposure Time parameter must not be set below a minimum specified value. The Exposure Time parameter sets the exposure time in microseconds ( $\mu s$ ). The minimum and maximum exposure time settings for the VC-101MX and VC-151MX cameras are shown in the following table.

Camera Model	Number of Channels	Minimum Exposure Time	Maximum Exposure Time †
VC-101MX	4 Channels	1 $\mu s$	60,000,000 $\mu s$
VC-151MX			

†: When the Exposure Mode is set to Trigger Width, the exposure time is controlled by the external trigger signal and has no maximum limit.

Table 8-1 Minimum and Maximum Exposure Time Setting

## 8.5 Overlapping Exposure with Sensor Readout

The frame acquisition process on the camera includes two distinct parts. The first part is the exposure of the pixels in the image sensor. Once exposure is complete, the second part of the process – readout of the pixel values from the sensor – takes place. In regard to this frame acquisition process, the VC-101MX/151MX cameras can be operated in the Overlapped acquisition mode or the Non-overlapped acquisition mode.

### 8.5.1 Overlapped

When the Trigger Mode parameter is set to Off (Free-run mode), the camera operates with ‘overlapped’ acquisition so that the exposure for a new frame can be overlapped with the sensor readout for the previous frame. The exposure of a new frame begins while the camera is still reading out the sensor data for the previously acquired frame.

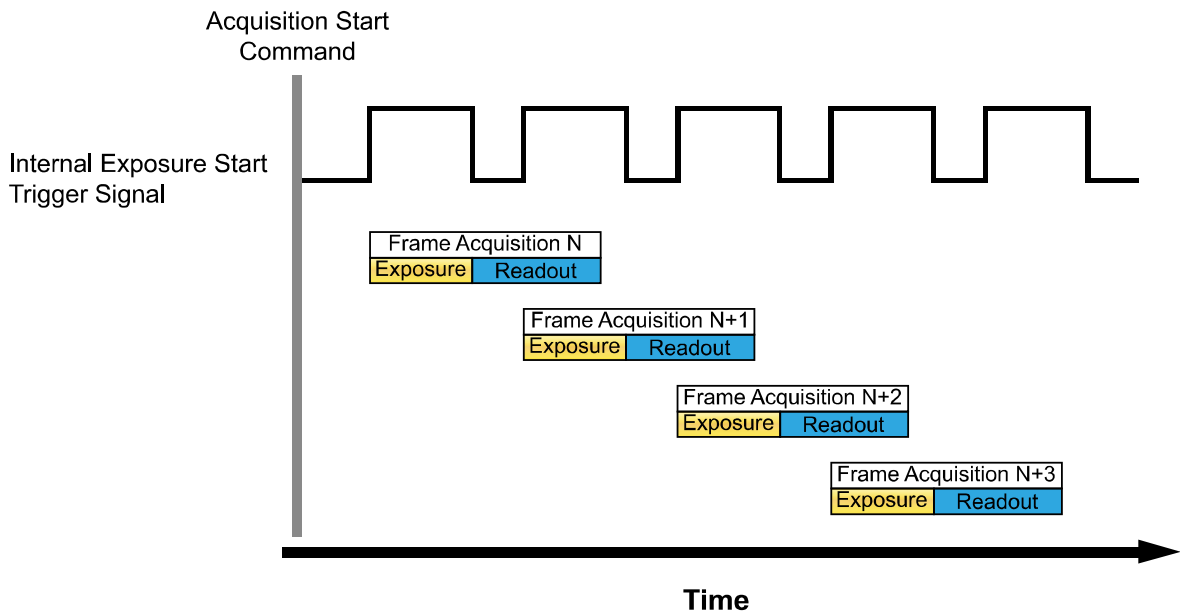

Figure 8-7 Overlapped Exposure and Readout



### 8.5.2 Non-overlapped

When the Trigger Mode parameter is set to On, each time a frame is acquired the camera completes the entire exposure/readout process before acquisition of the next frame is started. The exposure for a new frame does not overlap the sensor readout for the previous frame. The following figure illustrates the Trigger Mode parameter set to On, the Trigger Source parameter set to Line0, and the Exposure Mode parameter set to Trigger Width.

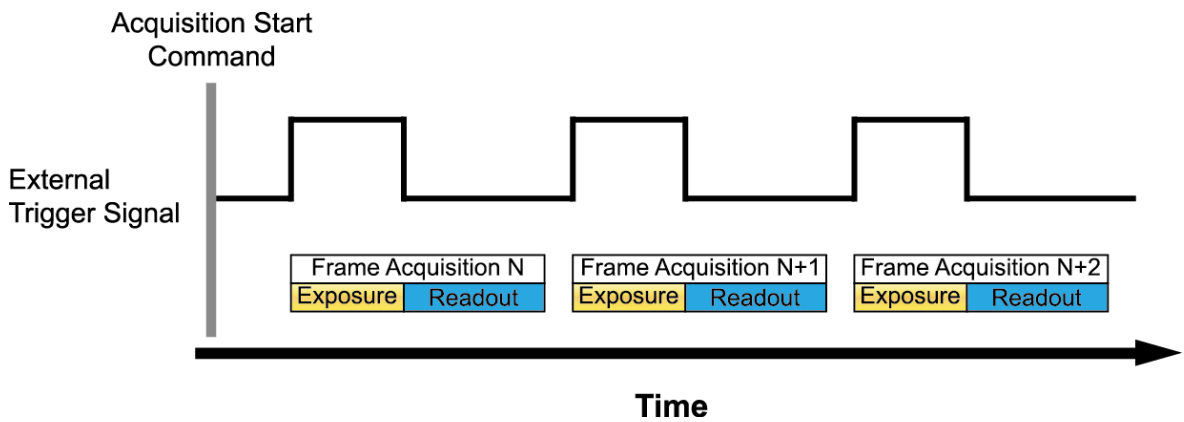

Figure 8-8 Non-overlapped Exposure and Sensor Readout

#### Guidelines for Non-overlapped Operation

If the Trigger Mode parameter is set to On and you are operating the camera in the non-overlapped mode, you must keep in mind the following:

- You must not begin the exposure for the current frame until the readout for the previous frame is complete.

When you are operating the camera with non-overlapped exposure and using an external trigger signal to trigger image acquisition, you could use the camera's Exposure Time parameter settings and readout time to calculate when it is safe to begin each new acquisition.

Camera Model	Readout Time
VC-101MX	12.91 $\mu$ s [1 horizontal line time] $\times$ 8854 [1 Vertical Period]
VC-151MX	15.0 $\mu$ s [1 horizontal line time] $\times$ 10760 [1 Vertical Period]

Table 8-2 Readout Time

### 8.6 Rolling Shutter

The VC-101MX/151MX cameras are equipped with an image sensor that has an electronic rolling shutter. The camera exposes and reads out the pixel line with a temporal offset ( $t_{Row}$ ) from one line to the next. When a trigger signal is applied to the camera, the camera resets the top line of pixels (Line 1) and begins exposing that line. The camera resets line two  $t_{Row}$  later and begins exposing the line. And so on until the bottom line of pixels (Line N) is reached. The pixel values for each line are read out at the end of exposure for the line. The readout time for each line is identical to the  $t_{Row}$  value.

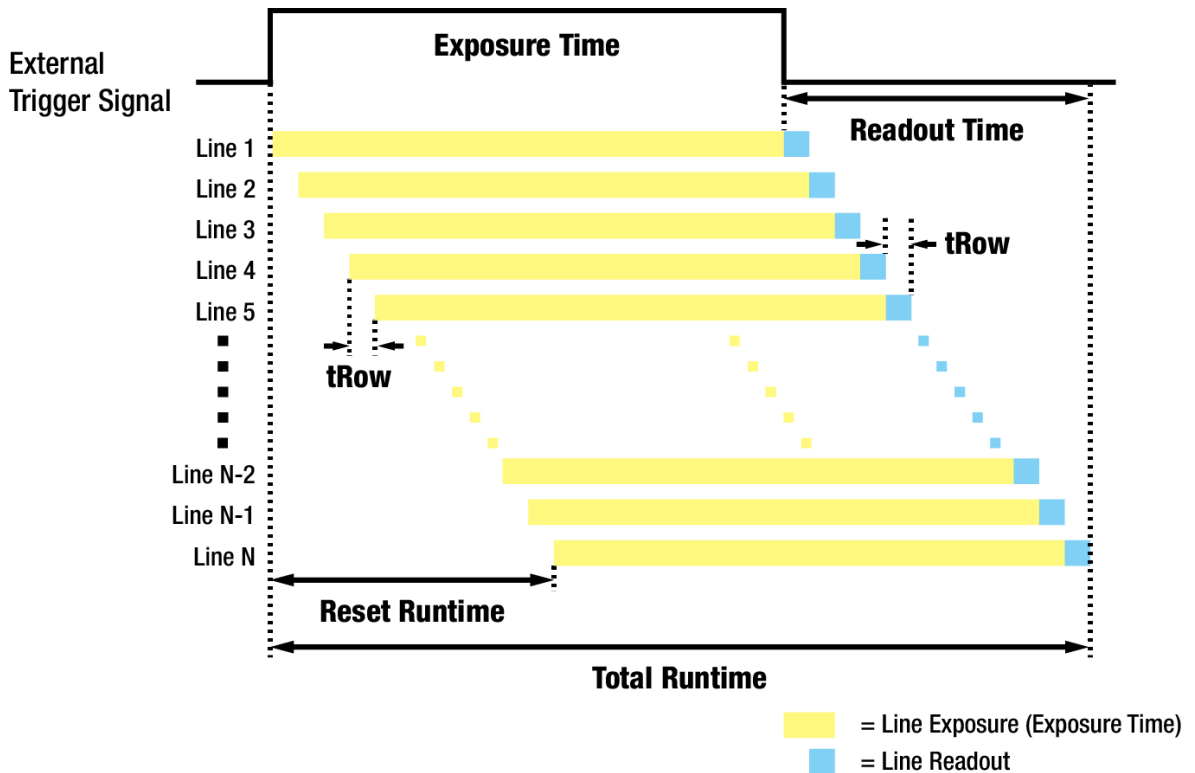

Figure 8-9 Rolling Shutter Operation

The tRow value for the VC-101MX camera depending on the camera's CoaXPress setting is as follows:

Number of Channels	tRow
4 Channels	12.91 $\mu$ s

Table 8-3 Temporal Offset Value for the VC-101MX

The tRow value for the VC-151MX camera depending on the camera's CoaXPress setting is as follows:

Number of Channels	tRow
4 Channels	15.0 $\mu$ s

Table 8-4 Temporal Offset Value for the VC-151MX

## 8.7 Maximum Allowed Frame Rate

In general, the maximum allowed acquisition frame rate on the camera may be limited by several factors:

- The amount of time that it takes to transmit an acquired frame from the camera to your computer. The amount of time needed to transmit a frame depends on the bandwidth assigned to the camera.
- The amount of time it takes to read an acquired frame out of the image sensor and into the camera's frame buffer. This time varies depending on the setting for the Height parameter. Frames with a smaller height take less time to read out of the sensor. The frame height is determined by the camera's Height settings in the Image Format Control category.
- The exposure time for acquired frames. If you use very long exposure time, you can acquire fewer frames per second.

### 8.7.1 Increasing the Maximum Allowed Frame Rate

You may find that you would like to acquire frames at a rate higher than the maximum allowed with the camera's current settings. In this case, you must adjust one or more of the factors that can influence the maximum allowed frame rate and then check to see if the maximum allowed frame rate has increased.

- The time that it takes to transmit a frame out of the camera is the main limiting factor on the frame rate. You can decrease the frame transmission time (and thus increase the maximum allowed frame rate) by using the ROI feature.  
Decreasing the size of the Image ROI may increase the maximum allowed frame rate. If possible, decrease the height of the Image ROI.
- If you are using normal exposure times and you are using the camera at its maximum resolution, your exposure time will not normally restrict the frame rate. However, if you are using long exposure time, it is possible that your exposure time is limiting the maximum allowed frame rate. If you are using a long exposure time, try using a shorter exposure time and see if the maximum allowed frame rate increases (You may need to compensate for a lower exposure time by using a brighter light source or increasing the opening of your lens aperture.).

**Note:**

A very long exposure time severely limits the camera's maximum allowed frame rate. As an example, assume that your camera is set to use a 1 second exposure time. In this case, because each frame acquisition will take at least 1 second to be completed, the camera will only be able to acquire a maximum of one frame per second.

## Chapter 9. Camera Features

### 9.1 Image Region of Interest

The Image Region of Interest (ROI) feature allows you to specify a portion of the sensor array. You can acquire only the frame data from the specified portion of the sensor array while preserving the same quality as you acquire a frame from the entire sensor array.

With the ROI feature, you can increase the maximum allowed frame rate by decreasing the Height parameter; however, decreasing the Width parameter does not affect the frame rate.

The ROI is referenced to the top left corner [origin (0, 0)] of the sensor array as shown below.

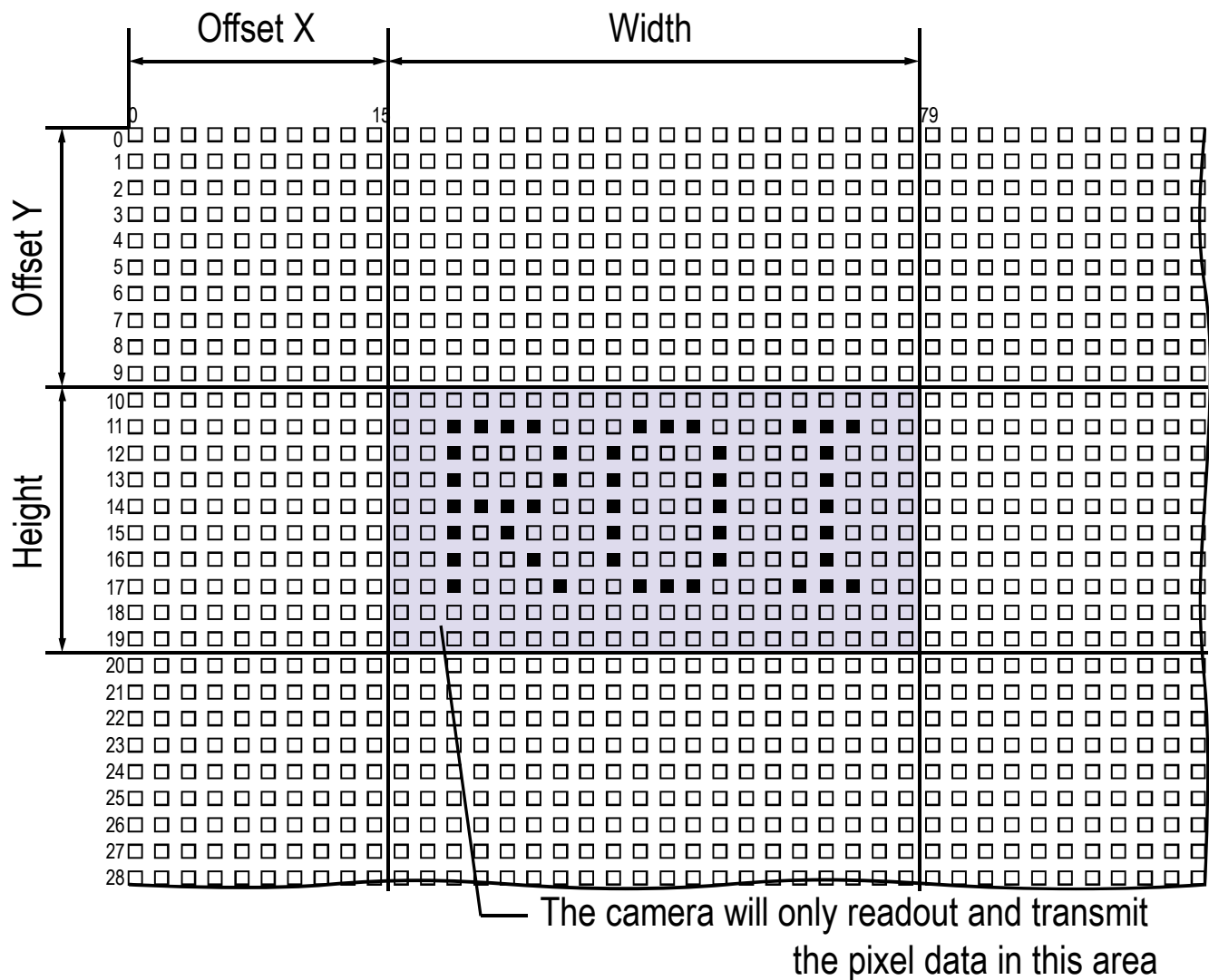

Figure 9-1 Region of Interest

The XML parameters related to ROI settings are as follows.

XML Parameters	Value	Description	
ImageFormatControl	SensorWidth <sup>a</sup>	-	Effective width of the sensor
	SensorHeight <sup>a</sup>	-	Effective height of the sensor
	WidthMax	-	Maximum allowed width of the image with the current camera settings
	HeightMax	-	Maximum allowed height of the image with the current camera settings
	Width <sup>b</sup>	-	Sets the Width of the Image ROI.
	Height <sup>b</sup>	-	Sets the Height of the Image ROI.
	OffsetX <sup>c</sup>	-	Sets the horizontal offset from the origin to the Image ROI.
	OffsetY <sup>c</sup>	-	Sets the vertical offset from the origin to the Image ROI.

The unit of all parameters in this table is pixel.

a: Read only. User cannot change the value.

b: User configurable parameters for setting ROI

c: User configurable parameters for setting the origin of the ROI.

Table 9-1 XML Parameters related to ROI

You can change the size of ROI by setting the **Width** and **Height** parameters in the Image Format Control category. You can also change the position of the ROI origin by setting the **Offset X** and **Offset Y** parameters. Make sure that the **Width + Offset X** value is less than the **Width Max** value, and the **Height + Offset Y** value is less than the **Height Max** value. You must set the size of the ROI first, and then set the Offset values since the **Width** and **Height** parameters are set to its maximum value by default.

- On the VC-101MX and VC-151MX cameras, the **Width** parameter must be set to a multiple of 16, and the **Height** parameter must be set to a multiple of 2.

The minimum allowed setting values for the ROI Width and Height are shown below.

Camera Model	Minimum Width Settings	Minimum Height Settings
VC-101MX	64	2
VC-151MX		

Table 9-2 Minimum ROI Width and Height Settings

On the VC-101MX camera, the maximum allowed frame rates depending on Vertical ROI changes are shown below.

ROI Size (H × V)	Max. Frame Rate
11648 × 2	679.1 fps
11648 × 2000	36.6 fps
11648 × 4000	18.8 fps
11648 × 6000	12.6 fps
11648 × 8000	9.5 fps
11648 × 8742	8.7 fps

Table 9-3 Maximum Frame Rates by VC-101MX Vertical ROI Changes

On the VC-151MX camera, the maximum allowed frame rates depending on Vertical ROI changes are shown below.

ROI Size (H × V)	Max. Frame Rate
14192 × 2	546.4 fps
14192 × 2000	31.4 fps
14192 × 4000	16.2 fps
14192 × 6000	10.9 fps
14192 × 8000	8.2 fps
14192 × 10640	6.2 fps

Table 9-4 Maximum Frame Rates by VC-151MX Vertical ROI Changes



**Caution!**

Your CXP Frame Grabber may place additional restrictions on how the ROI location and size must be set. Refer to your CXP Frame Grabber user manual for more information.

## 9.2 Binning (Monochrome Only)

The Binning has the effects of increasing the level value and decreasing resolution by summing the values of the adjacent pixels and sending them as one pixel. The XML parameters related to Binning are as follows.

XML Parameters		Value	Description
Image Format Control	BinningSelector	Sensor	Selects the Sensor for the binning engine. Applies the Binning in analog by the image sensor.
		Logic	Selects the Logic for the binning engine. Applies the Binning in digital by the logic.
BinningHorizontal Mode	BinningHorizontal	Sum	According to the Binning Selector setting: <ul style="list-style-type: none"> <li>Sensor: N/A</li> <li>Logic: Adds pixel values from the adjacent pixels as specified in the Binning Horizontal, and then sends them as one pixel.</li> </ul>
		Average	According to the Binning Selector setting: <ul style="list-style-type: none"> <li>Sensor: Updated automatically according to the Binning Vertical Mode.</li> <li>Logic: Adds pixel values from the adjacent pixels as specified in the Binning Horizontal and divides them by the number of combined pixels, and then sends them as one pixel.</li> </ul>
BinningHorizontal	BinningHorizontal	×1, ×2, ×3, ×4	According to the Binning Selector setting: <ul style="list-style-type: none"> <li>Sensor: Updated automatically according to the BinningVertical.</li> <li>Logic: The number of horizontal pixels to combine together (×1, ×2, ×4).</li> </ul>
BinningVertical Mode	BinningVertical	Sum	According to the Binning Selector setting: <ul style="list-style-type: none"> <li>Sensor: N/A</li> <li>Logic: Adds pixel values from the adjacent pixels as specified in the Binning Vertical, and then sends them as one pixel.</li> </ul>
		Average	Adds pixel values from the adjacent pixels as specified in the Binning Vertical parameter and divides them by the number of combined pixels, and then sends them as one pixel.
BinningVertical	BinningVertical	×1, ×2, ×3, ×4	The number of vertical pixels to combine together. <ul style="list-style-type: none"> <li>Sensor: ×1, ×3</li> <li>Logic: ×1, ×2, ×4</li> </ul>

Table 9-5 XML Parameters related to Binning



### Caution!

- The Binning feature is only available when the Pixel Format is set to 8, 10 or 12-bit.
- When the Binning Selector is set to Sensor, the Average binning is only available.
- When the Binning Selector is set to Sensor, ×1 or ×3 is only available.
- When the Binning Selector is set to Logic, ×1, ×2 or ×3 is only available.



For example, if you set the **Binning Selector** to **Logic** and set  $2 \times 2$  binning, the camera's resolution is reduced to  $1/4$ . If you set the **Binning Horizontal/Vertical Mode** to **Sum**, the maximum allowed resolution of the image is reduced to  $1/2$  and the responsivity of the camera is quadrupled. If you set the **Binning Horizontal/Vertical Mode** to **Average**, the maximum allowed resolution of the image is reduced to  $1/2$ , but there is no difference in responsivity between a binned image and an original image.

You can also use both the Sensor and Logic binning engines simultaneously. For example, you can set the **Binning Selector** to **Sensor**, **Binning Horizontal/Vertical Mode** to **Average**, and the **Binning Vertical** to  $\times 3$ . Then, you can set the **Binning Selector** to **Logic**, **Binning Horizontal/Vertical Mode** to **Average**, and the **Binning Horizontal/Vertical** to  $\times 4$ . With these settings, you can implement  $12 \times 12$  binning.

The **Width Max** and **Height Max** parameters, indicating the maximum allowed resolution of the image with the current camera settings, will be updated according to the binning settings. The **Width**, **Height**, **Offset X** and **Offset Y** parameters also will be updated according to the binning settings. You can verify the current resolution through the **Width** and **Height** parameters.

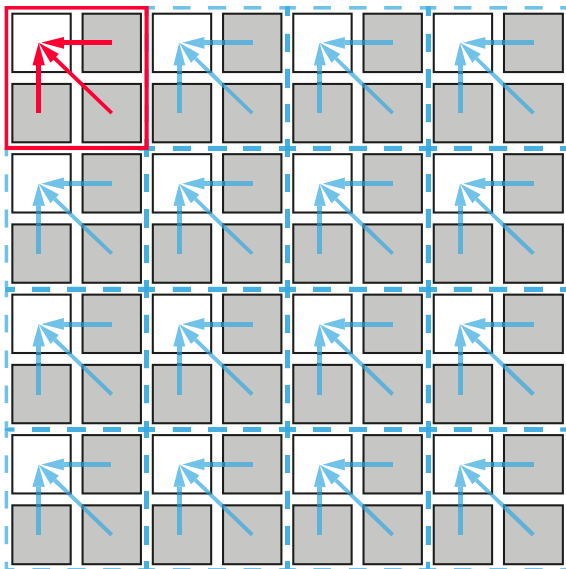

Figure 9-2  $2 \times 2$  Binning

### 9.3 CXP Link Configuration

The VC-101MX/151MX cameras must be connected to a CXP Frame Grabber installed in your computer via CoaXPRESS interface. CoaXPRESS interface allows you to connect a camera to a CXP Frame Grabber by using simple coax cabling and allows up to 6.25 Gbps data rate per cable. The VC-101MX/151MX cameras support one master connection and up to three extension connections to configure a link. In compliance with the CoaXPRESS standard, the VC-101MX/151MX cameras include an automatic link detection mechanism (Plug and Play) to correctly detect the camera to CXP Frame Grabber connections.

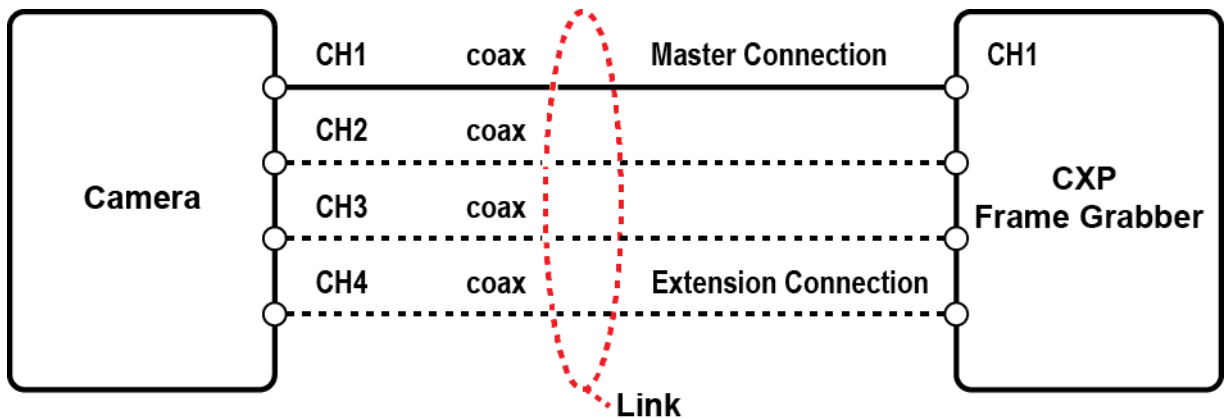

Figure 9-3 CXP Link Configuration

The XML parameters related to the link configuration between the camera and CXP Frame Grabber are as follows.

XML Parameters	Value	Description
CoaXPRESS CxpLinkConfiguration PreferredSwitch	CXP6_X1	Sets the ^ parameter value to CXP6_X1.
	CXP6_X2	Sets the ^ parameter value to CXP6_X2.
	CXP6_X4	Sets the ^ parameter value to CXP6_X4.
CxpLinkConfiguration Preferred^	Read Only	Displays bit rate and the number of connections to be set for the link configuration between the camera and Host (Frame Grabber) while discovering devices.
CXPLinkConfiguration	CXP6_X1	Forcefully sets bit rate and the number of connections for the link configuration. ex) CXP6_X4: Four connections running at a maximum of CXP6 speed (6.25 Gbps).
	CXP6_X2	
	CXP6_X4	

Table 9-6 XML Parameters related to CXP Link Configuration

## 9.4 Pixel Format

You can determine the pixel format (8 bits, 10 bits, 12 bits, 14 bits or 16 bits) of these image data transmitted from the camera by selecting the **Pixel Format** parameter.

The XML parameter related to Pixel Format is as follows.

XML Parameter	Description
ImageFormatControl    PixelFormat	Sets the pixel format supported by the device.

Table 9-7 XML Parameter related to Pixel Format

The available pixel formats on the monochrome and color cameras are as follows.

Mono Sensor	Color Sensor
Mono 8	Mono 8
Mono 10	Mono 10
Mono 12	Mono 12
Mono 14	Mono 14
Mono 16	Mono 16
	Bayer RG 8
	Bayer RG 10
	Bayer RG 12
	Bayer RG 14
	Bayer RG 16

Table 9-8 Pixel Format Values

### 9.5 Data ROI (Color Camera)

The Balance White Auto feature provided by the color camera uses the pixel data from a Data Region of Interest (ROI) to adjust the related parameters. The XML parameters related to Data ROI are as follows.

XML Parameters	Value	Description
DataRoiControl	RoiSelector	WhiteBalance Auto
	RoiOffsetX	-
	RoiOffsetY	-
	RoiWidth	-
	RoiHeight	-

Table 9-9 XML Parameters related to Data ROI

Only the pixel data from the area of overlap between the data ROI by your settings and the Image ROI will be effective if you use Image ROI and Data ROI at the same time. The effective ROI is determined as shown in the figure below.

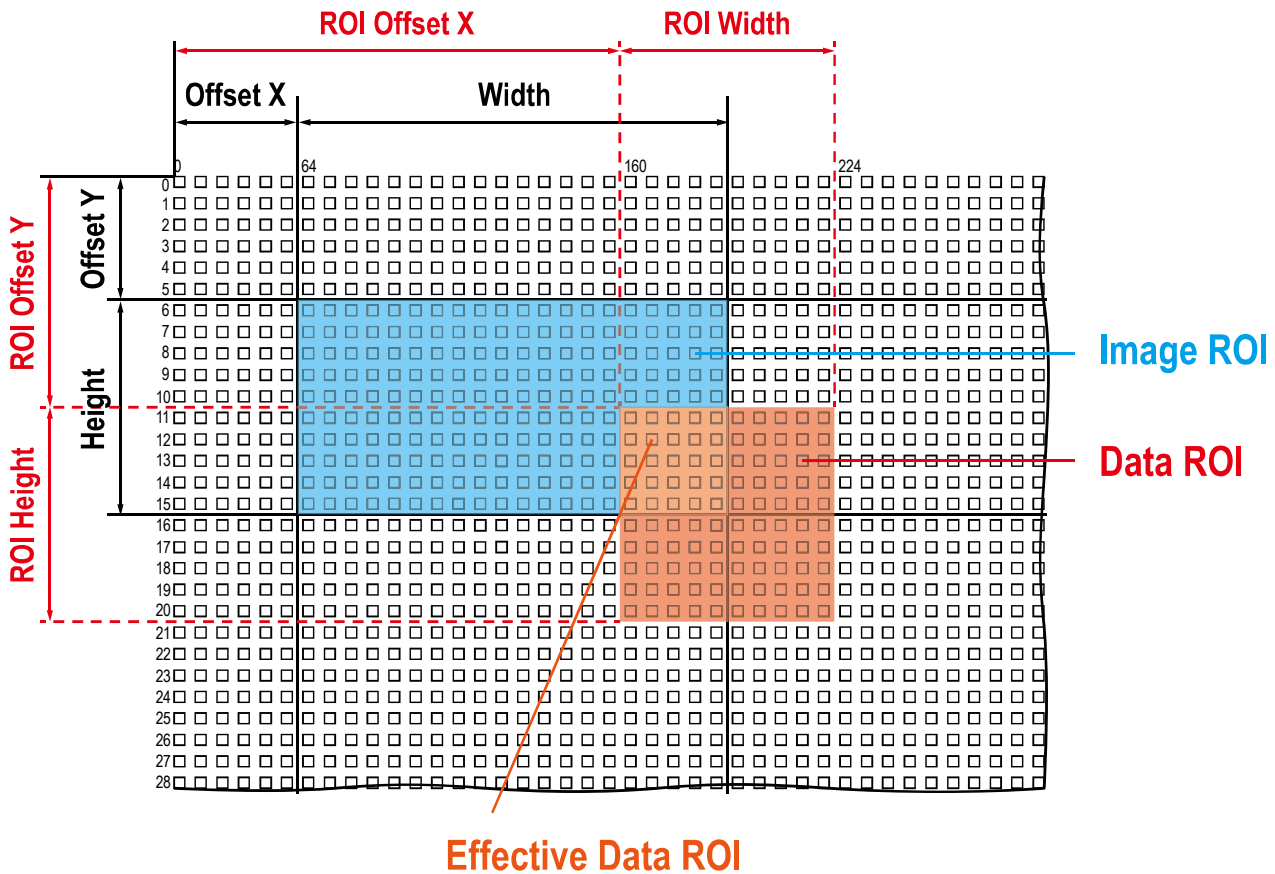

Figure 9-4 Effective Data ROI

## 9.6 White Balance (Color Only)

The color camera includes the white balance capability to adjust the color balance of the images transmitted from the camera. With the white balancing scheme used on the VC-101MX/151MX cameras, the Red, Green and Blue intensities can be adjusted individually. You can set the intensity of each color by using the **Balance Ratio** parameter. The **Balance Ratio** value can range from 1.0 to 4.0. If the **Balance Ratio** parameter is set to 1.0 for a color, the intensity of the color will be unaffected by the white balance mechanism. If the **Balance Ratio** parameter is set to greater than 1.0, the intensity of the color will be proportionally increased to the ratio. For example, if the **Balance Ratio** is set to 1.5, the intensity of that color will be increased by 50%. The XML parameters related to White Balance are as follows.

XML Parameters		Value	Description
Analog Control	BalanceRatio Selector	Red	A Balance Ratio value will be applied to red pixels.
		Green	A Balance Ratio value will be applied to green pixels.
		Blue	A Balance Ratio value will be applied to blue pixels.
	BalanceRatio	×1.0 ~ ×4.0	Adjusts the ratio of the selected color.

Table 9-10 XML Parameters related to White Balance

### 9.6.1 Balance White Auto

The Balance White Auto feature is implemented on the color camera. It will control the white balance of the image acquired from the color camera according to the GreyWorld algorithm. Before using the Balance White Auto feature, you need to set the Data ROI for Balance White Auto. If you do not set the related Data ROI, the pixel data from the Image ROI will be used to control the white balance. As soon as the **Balance White Auto** parameter is set to **Once**, the Balance Ratio values for Red and Blue will be automatically adjusted to adjust the white balance by referring to Green.

The XML parameters related to Balance White Auto are as follows.

XML Parameter		Value	Description
AnalogControl	BalanceWhite Auto	Off	Balance White Auto Off
		Once	White Balance is adjusted once and then Off.

Table 9-11 XML Parameter related to Balance White Auto

## 9.7 Gain and Black Level

Increasing the **Gain** parameter increases all pixel values of the image. This results in a higher grey value output from the camera for a given amount of output from the image sensor.

1. Selects the **Gain Control** (**Digital All** is only available) to be adjusted by using the **Gain Selector** parameter.
2. Sets the **Gain** parameter to the desired value.

Adjusting the **Black Level** parameter will result in an offset to the pixel values output from the camera.

1. Selects the **Black Level Control** (**Digital All** is only available) to be adjusted by using the **Black Level Selector** parameter.
2. Sets the **Black Level** parameter to the desired value. The available setting range varies depending on the **Pixel Format** settings.

The XML parameters related to **Gain** and **Black Level** are as follows.

XML Parameters		Value	Description
AnalogControl	GainSelector	DigitalAll	Applies the <b>Gain</b> value to all digital channels.
	Gain	1.0× ~ 32.0×	Sets a digital gain value.
	BlackLevelSelector	DigitalAll	Applies the <b>Black Level</b> value to all digital channels.
	BlackLevel	0 ~ 4095	Sets a black level value (The setting range is based on the 16-bit <b>Pixel Format</b> .).

Table 9-12 XML Parameters related to **Gain** and **Black Level**

## 9.8 Hot Pixel Correction

When you acquire images with long exposure times or operate the camera under the condition of high ambient temperature, hot pixels may be appeared on the images due to the characteristics of the high resolution CMOS image sensor. The VC-101MX/151MX cameras provide the Hot Pixel Correction feature to remove hot pixels.

The XML parameter related to Hot Pixel Correction is as follows.

XML Parameters		Value	Description
DSNUControl	HotPixelCorrection	Off	Disables the Hot Pixel Correction feature.
		On	Enables the Hot Pixel Correction feature.

Table 9-13 XML Parameter related to Hot Pixel Correction

## 9.9 Dynamic Defective Pixel Correction

When you acquire images with the Defective Pixel Correction feature (refer to 9.10 Defective Pixel Correction) enabled, some pixels may appear brighter or darker than the other pixels due to long exposure times, high gain settings or high operating temperatures. The VC-101MX/151MX cameras provide the Dynamic Defective Pixel Correction feature to remove these defect pixels. If you set the Dynamic Defective Pixel Correction parameter to TRUE, pixels considerably brighter or darker than adjacent pixels will be replaced with the Median value of adjacent 3 × 3 pixels. You can adjust the range of defect pixel values to be replaced with the Median value by setting the Defective Pixel Offset Threshold parameter.

The XML parameters related to Dynamic Defective Pixel Correction are as follows.

XML Parameters		Value	Description
ImageFormatControl	DynamicDefectivePixel Correction	FALSE	Disables the Dynamic DPC feature.
		TRUE	Enables the Dynamic DPC feature.
	DefectivePixel OffsetThreshold	0 ~ 32768 (at 16 bit)	Sets the Threshold Offset value of the Median filter. You can adjust the range of defect pixel values by setting this value.

Table 9-14 XML Parameters related to Dynamic Defective Pixel Correction

The range of defect pixel values can be determined by  $\pm 20\%$  of adjacent  $3 \times 3$  pixels' average and  $\pm$ Offset Threshold values.

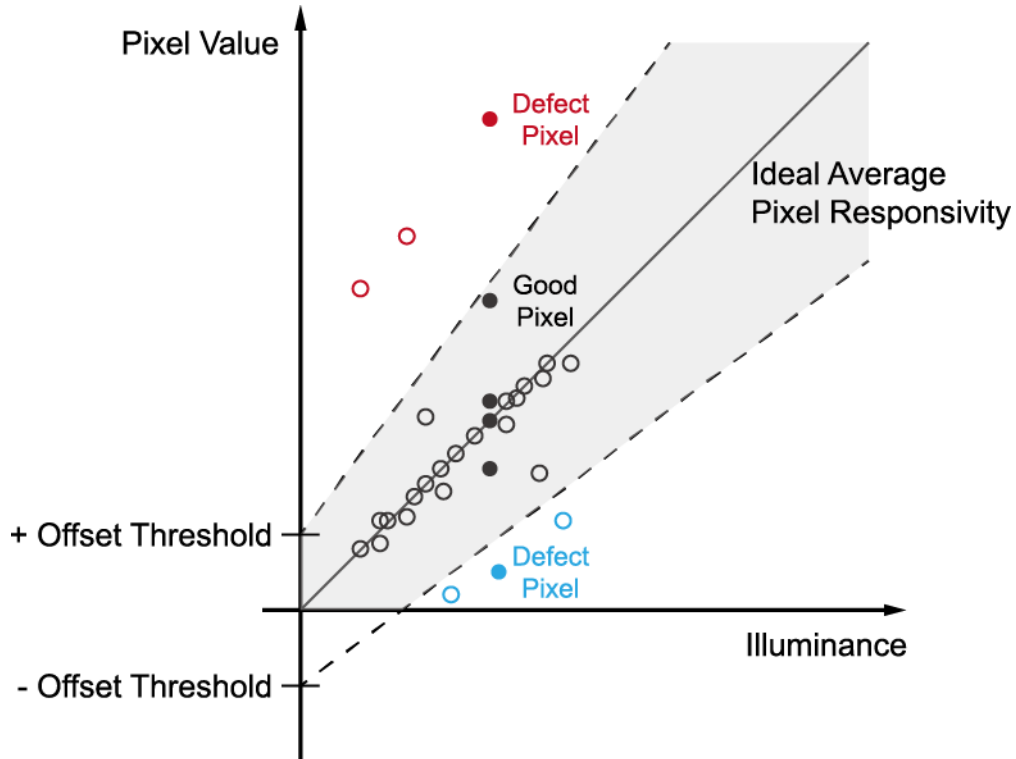

Figure 9-5 Dynamic Defective Pixel Correction



## 9.10 Defective Pixel Correction

The CMOS sensor may have defect pixels which cannot properly react to the light. Correction is required since it may deteriorate the quality of output image. Defect pixel information of CMOS used for each camera is entered into the camera during the manufacturing process. If you want to add defect pixel information, it is required to enter coordinate of new defect pixel into the camera. For more information, refer to Appendix A.

### 9.10.1 Correction Method

A correction value for a defect pixel is calculated based on the valid pixel value adjacent in the same line.

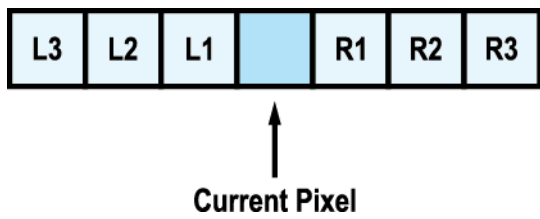

Figure 9-6 Location of Defect Pixel to be corrected

If the Current Pixel is a defect pixel as shown in the figure above, the correction value for this pixel is obtained as shown in the following table depending on whether surrounding pixels are defect pixels or not.

Adjacent Defect Pixel (s)	Correction Value of Current Pixel
None	$(L1 + R1) / 2$
L1	R1
R1	L1
L1, R1	$(L2 + R2) / 2$
L1, R1, R2	L2
L2, L1, R1	R2
L2, L1, R1, R2	$(L3 + R3) / 2$
L2, L1, R1, R2, R3	L3
L3, L2, L1, R1, R2	R3

Table 9-15 Calculation of Defect Pixel Correction Value

## 9.11 Flat Field Correction

The Flat Field Correction feature improves the image uniformity when you acquire a non-uniformity image due to external conditions. The Flat Field Correction feature of the VC-101MX and VC-151MX cameras can be summarized by the following equation:

$$IC = (IR \times M) / IF$$

IC: Level value of corrected image

IR: Level value of original image

M: Target value of image after correction

IF: Level value of Flat Field data

In actual use conditions, generate a Flat Field correction data and then save the data into the non-volatile memory of the camera by following the procedure below.

1. Select Auto or User Set by using the Flat Field Target Selector parameter.
  - Auto: The camera automatically adjusts the target value of the image after correction.
  - User Set: Allows you to set the user-defined target value of the image by using the Flat Field Target Level parameter.
2. Execute the Flat Field Data Generate parameter.

After executing the Flat Field Data Generate parameter, you must acquire one image to generate the scaled-down Flat Field correction data.
3. Use the Flat Field Data Selector parameter to specify a location to save the generated Flat Field correction data.
4. Execute the Flat Field Data Save parameter to save the generated Flat Field data into the non-volatile memory. When the scaled-down Flat Field data are used for correction, they are expanded and applied with a Bilinear Interpolation as shown in the **Figure 9-8**.

To disregard the generated Flat Field correction data and use the previous Flat Field correction data, execute the Flat Field Data Load parameter before executing the Flat Field Data Save parameter.

5. Set the Flat Field Correction parameter to On to apply the Flat Field data to the camera.

**Caution!**

- It is recommended that you enable the Defective Pixel Correction feature before executing the Flat Field Data Generate parameter.
- Before executing the Flat Field Data Generate parameter, you must set the camera as follows:  
OffsetX, Y: 0  
Width, Height: Maximum values
- After executing an Acquisition Start command, you need to operate the camera with free-run mode or apply a trigger signal to acquire an image.

The XML parameters related to Flat Field Correction are as follows.

XML Parameters	Value	Description
FlatField Control	FlatFieldCorrection Off	Disables the Flat Field Correction feature.
	FlatFieldCorrection On	Enables the Flat Field Correction feature.
FlatFieldDataSelector	Space0 - Space15	Selects a location to save Flat Field data to or load Flat Field data from. Space0~Space15:User defined location
FlatFieldTargetSelector	Auto	Auto-adjusts the target value of the image after correction.
	User Set	Manually sets the target value of the image after correction.
FlatFieldTargetLevel	1 - 65535	Sets the target value of the image after correction when FlatFieldTargetSelector is set to User Set. The setting range is based on the 16-bit Pixel Format.
FlatFieldDataGenerate	-	Generates the Flat Field data.
FlatFieldDataSave	-	Saves the generated Flat Field correction data in the non-volatile memory. The generated data by executing the Flat Field Data Generate parameter are saved in the volatile memory so that the data are lost if the camera is reset or if power is turned off. To use the data after the camera is powered on or reset, save them in the non-volatile memory.
FlatFieldDataLoad	-	Loads the Flat Field data from the non-volatile memory into volatile memory.

Table 9-16 XML Parameters related to Flat Field Correction

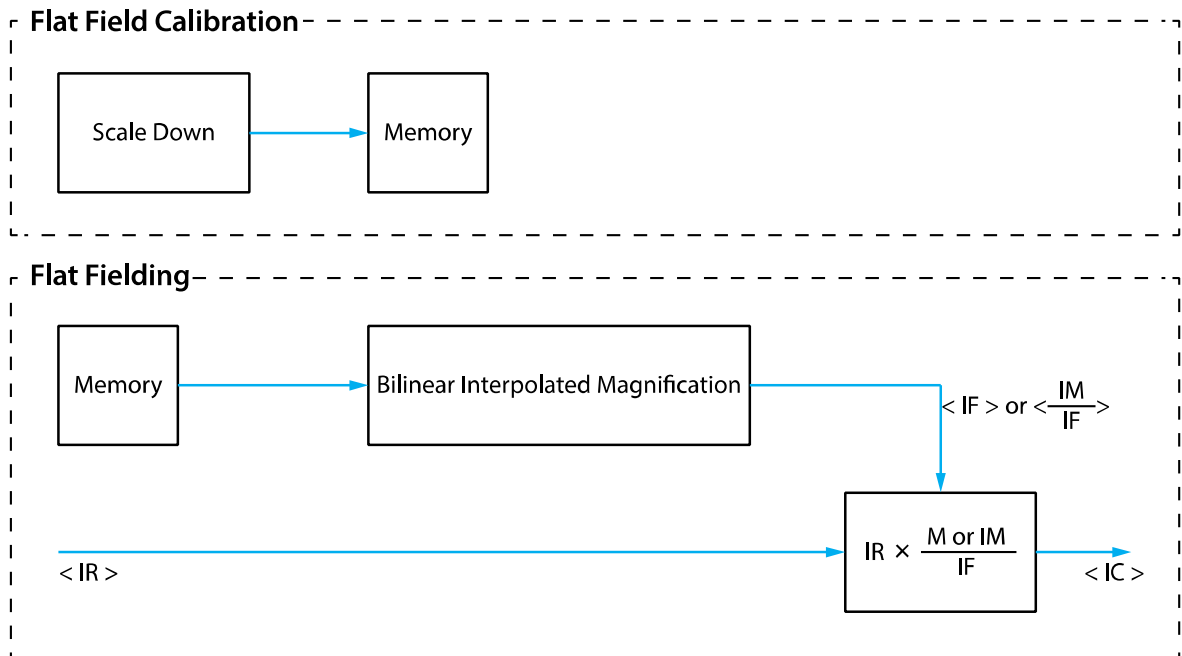

Figure 9-7 Generation and Application of Flat Field Data

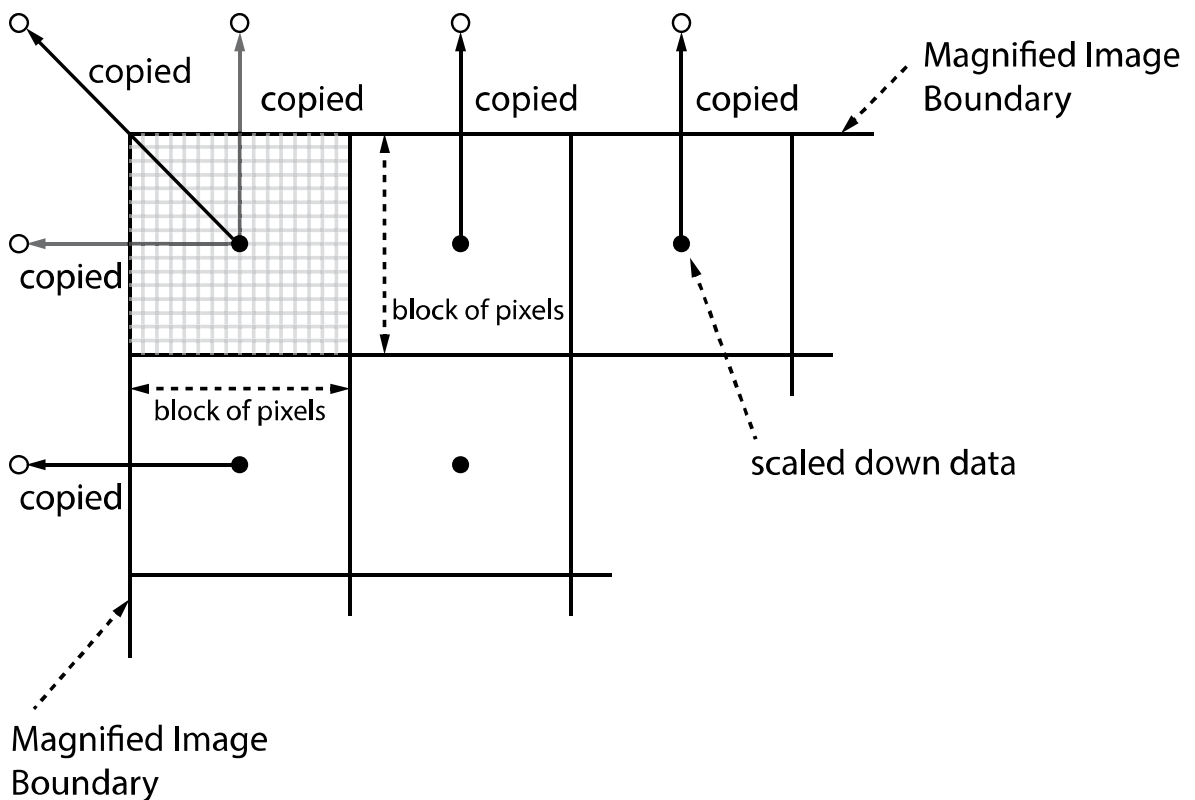

Figure 9-8 Bilinear Interpolated Magnification

### Flat Field Data Selector

As mentioned above, the generated Flat Field correction data is stored in the camera's volatile memory and the data is lost if the camera is reset or powered off. To use the generated Flat Field correction data after the camera is powered on or reset, you need to save them in the camera's non-volatile memory. The VC-101MX and VC-151MX cameras provide sixteen reserved locations in the camera's non-volatile memory available for saving and loading the Flat Field correction data. You can use the Flat Field Data Selector parameter to select a location as desired.

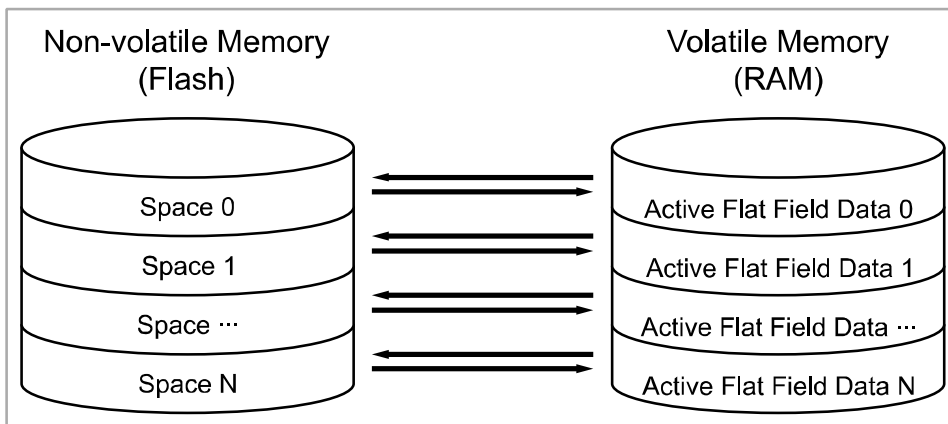

Figure 9-9 Flat Field Data Selector

### Saving Flat Field Data

There is a one-to-one correspondence between active Flat Field data locations in the volatile memory and Flat Field data storage locations in the non-volatile memory. In order to save the generated Flat Field data into a reserved location in the camera's flash memory, you must choose a Flat Field data location before generating Flat Field data by using the **Flat Field Data Selector** parameter.

1. Use the **Flat Field Data Selector** parameter to specify a Flat Field data location, and then generate Flat Field data.
2. Execute the **Flat Field Data Save** parameter to save the generated Flat Field data to the selected location.

### Loading Flat Field Data

If Flat Field data are saved in the camera's non-volatile memory, you can load the saved Flat Field data from the camera's non-volatile memory into the camera's active Flat Field correction data location.

1. Use the **Flat Field Data Selector** parameter to specify the desired Flat Field data storage location. The Flat Field correction data will be applied when the Flat Field Correction feature is enabled on the camera.
2. To ignore newly generated Flat Field correction data and load the previous Flat Field correction data, execute the **Flat Field Data Load** parameter.

### 9.12 Digital I/O Control

The control I/O receptacle of the camera can be operated in various modes.

The XML parameters related to Digital I/O Control are as follows.

XML Parameters	Value	Description
DigitalIOControl	LineSelector	Line1 Selects the number 4 pin of the camera's control I/O receptacle as an output line.
	LineInverter	FALSE Disables inversion on the output signal of the line.
		TRUE Enables inversion on the output signal of the line.
	LineSource	Off Disables the line output.
		ExposureActive Outputs pulse signals indicating the current exposure time.
		FrameActive Outputs pulse signals indicating a frame readout time.
		UserOutput0 Outputs pulse signals set by User Output Value.
		Timer0Active Outputs user-defined Timer signals as pulse signals.
		Strobe Outputs strobe signals (goes high when the exposure time for the bottom line of pixels begins and goes low when the exposure time for the top line of pixels ends) as pulse signals.
	UserOutput Value	FALSE Sets the bit state of the line to Low.
		TRUE Sets the bit state of the line to High.
	Debounce Time	0 ~ 1,000,000 Sets a Debounce time value in microseconds (Default: 0.5 $\mu$ s).

Table 9-17 XML Parameters related to Digital I/O Control

When you set the Line Source to User Output0, you can use the user setting values as output signals.

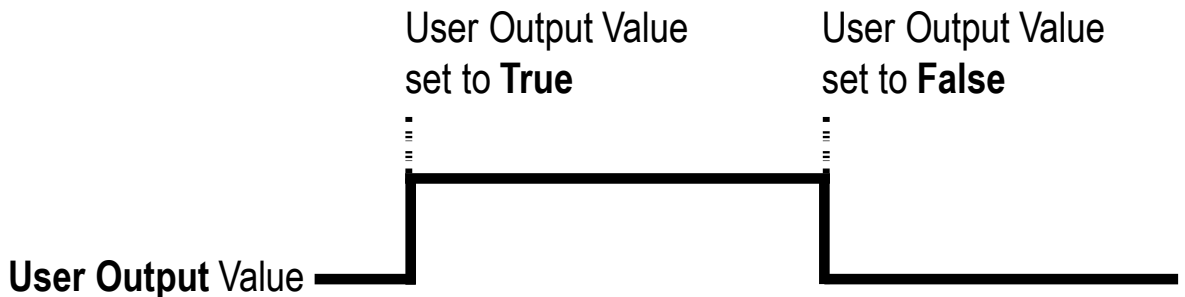

Figure 9-10 User Output

The camera can provide an Exposure Active output signal. The signal goes high when the exposure time for each frame acquisition begins and goes low when the exposure time ends as shown in the figure below. This signal can be used as a flash trigger and is also useful when you are operating a system where either the camera or the object being imaged is movable. Typically, you do not want the camera to move during exposure. You can monitor the Exposure Active signal to know when exposure is taking place and thus know when to avoid moving the camera.

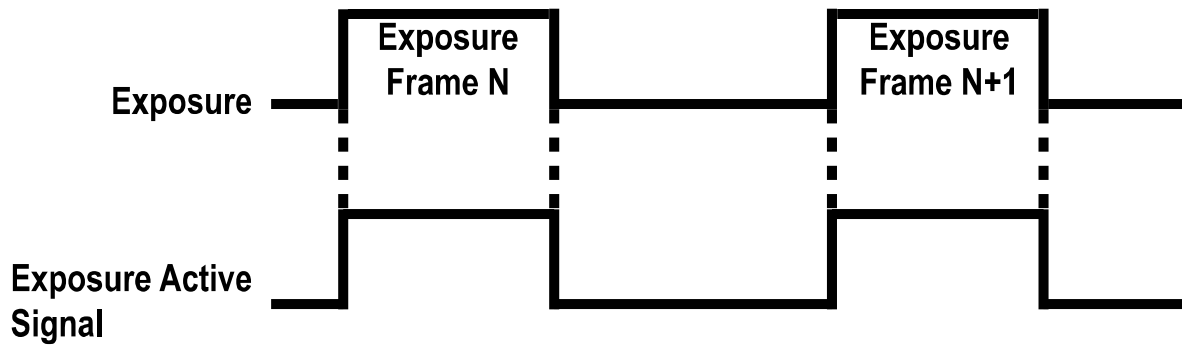

Figure 9-11 Exposure Active Signal



**Strobe**

When the Line Source parameter is set to **Strobe**, the camera can output Strobe signals. Typically, the strobe signal goes high when the exposure time begins and goes low when the exposure time ends. This signal can be used as a flash trigger and is also useful when you are operating a system where either the camera or the object being imaged is movable. Typically, you do not want the camera to move during exposure. You can monitor the Strobe signal to know when exposure is taking place and thus know when to avoid moving the camera.

The VC-101MX/151MX cameras provide the Strobe signal as shown in the figure below. The Strobe signal goes high when the exposure time for the bottom line of pixels begins and goes low when the exposure time for the top line of pixels ends. The Strobe signal is only available when the exposure time is longer than the readout time and is useful when you are operating the camera under the flash lighting conditions.

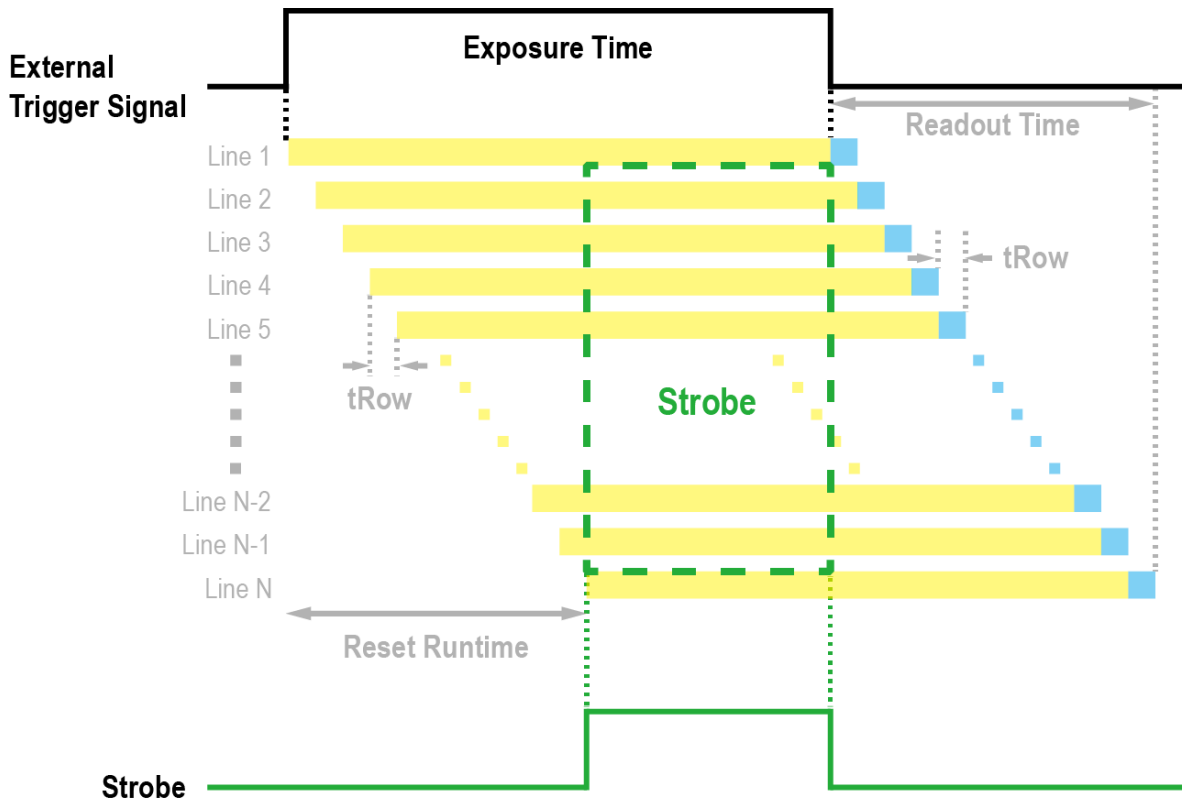

Figure 9-12 Strobe Signal

**Debounce**

The Debounce feature of the VC-101MX/151MX cameras allows to supply only valid signals to the camera by discriminating between valid and invalid input signals. The Debounce Time parameter specifies the minimum time that an input signal must remain High or Low in order to be considered as a valid input signal. When you use the Debounce feature, be aware that there is a delay between the point where the valid input signal arrives and the point where the signal becomes effective. The duration of the delay is determined by the Debounce Time parameter setting value. When you set the Debounce Time parameter, High and Low signals shorter than the setting value are considered invalid and ignored as shown in the figure below.

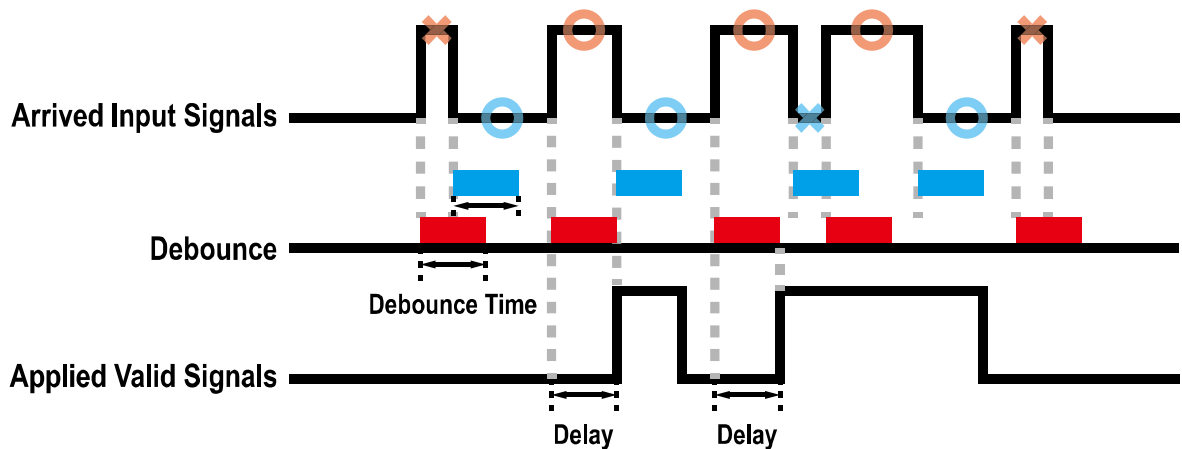

Figure 9-13 Debounce

The XML parameter related to Debounce Time is as follows.

XML Parameters	Value	Description
DigitalIOControl Debounce Time	0 – 1,000,000 $\mu$ s	Sets a Debounce Time value in microseconds (Default: 0.5 $\mu$ s).

Table 9-18 XML Parameter related to Debounce Time

## 9.13 Timer Control

When the Line Source parameter is set to `Timer0Active`, the camera can provide output signals by using the Timer. On the VC-101MX/151MX cameras, the Frame Active, Exposure Active event, Strobe or external trigger signal is available as Timer source signal.

The XML parameters related to Timer are as follows.

XML Parameters	Value	Description
CounterAnd TimerControl	TimerDuration	0 ~ 60,000,000 $\mu$ s
	TimerDelay	0 ~ 60,000,000 $\mu$ s
	TimerReset	-
	TimerTrigger Source	Off
		ExposureActive
		FrameActive
		Line0
		Strobe
	TimerTrigger Activation	RisingEdge
		FallingEdge
		LevelHigh
		LevelLow

Table 9-19 XML Parameters related to Timer Control

For example, when the Timer Trigger Source is set to Exposure Active and the Timer Trigger Activation is set to Level High, the Timer will act as follows:

1. When the source signals set by the Timer Trigger Source parameter are applied, the Timer will start operations.
2. The delay set by the Timer Delay parameter begins to expire.
3. When the delay expires, the Timer signal goes high as long as the source signal is high.

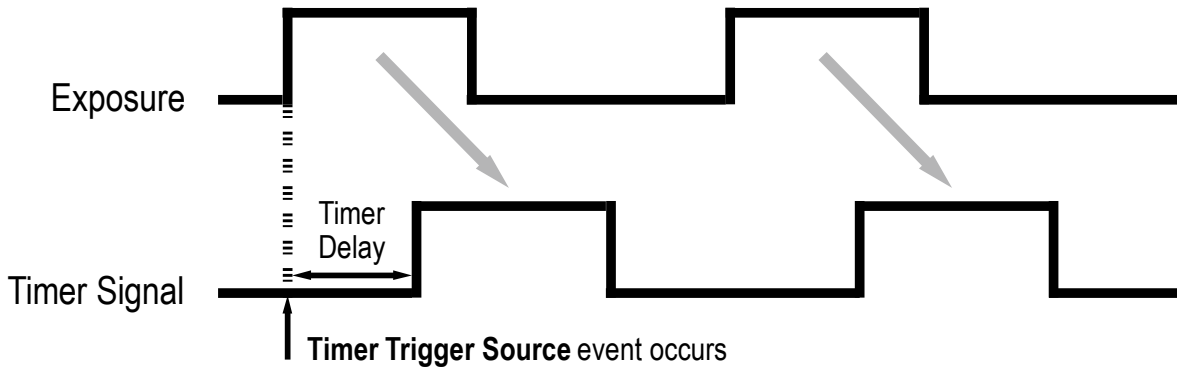

\* **Timer Trigger Activation** is set to **Level High**.

Figure 9-14 Timer Signal

### 9.14 Cooling Control

A fan is installed on the rear panel of the camera to radiate heat. You can set the fan to turn on or off. You can also set the fan to turn on when a specified internal temperature is reached.

The XML parameters related to Cooling Control are as follows.

XML Parameters	Value	Description
CoolingControl TargetTemperature	-10°C ~ 80°C	Sets the temperature to operate the fan when the FanOperationMode parameter is set to Temperature.
FanOperationMode	Off	Turns off the fan.
	On	Turns on the fan.
	Temperature	Turns on the fan when the internal temperature exceeds the value set in the Target Temperature parameter.
FanSpeed	-	Displays the current Fan RPM.

Table 9-20 XML Parameters related to Cooling Control

## 9.15 Temperature Monitor

The camera has an embedded sensor chip to monitor the internal temperature.

The XML parameters related to Device Temperature are as follows.

XML Parameters	Value	Description
DeviceControl DeviceTemperatureSelector	Mainboard	Sets a temperature measuring spot to the mainboard.
DeviceTemperature	-	Displays device temperature in Celsius.

Table 9-21 XML Parameters related to Device Temperature

## 9.16 Status LED

A LED is installed on the rear panel of the camera to inform the operation status of the camera.

LED status and corresponding camera status are as follows:

Status LED	Description
Steady Red	The camera is not initialized.
Slow Flashing Red	A CXP Link is not configured.
Fast Flashing Orange	The camera is checking a CXP Link configuration.
Steady Green	A CXP Link is configured.
Fast Flashing Green	The camera is transmitting image data.

Table 9-22 Status LED

## 9.17 Test Pattern

To check whether the camera operates normally or not, it can be set to output test patterns generated in the camera, instead of image data from the image sensor. Three types of test patterns are available; image with different value in horizontal direction (Grey Horizontal Ramp), image with different value in diagonal direction (Grey Diagonal Ramp) and moving image with different value in diagonal direction (Grey Diagonal Ramp Moving).

The XML parameter related to Test Pattern is as follows.

XML Parameters	Value	Description
ImageFormat TestPattern Control	Off	Disables the Test Pattern feature.
	GreyHorizontalRamp	Sets to Grey Horizontal Ramp.
	GreyDiagonalRamp	Sets to Grey Diagonal Ramp.
	GreyDiagonalRampMoving	Sets to Grey Diagonal Ramp Moving.
	SensorSpecific	Sets to the Test Pattern provided by the image sensor.

Table 9-23 XML Parameters related to Test Pattern

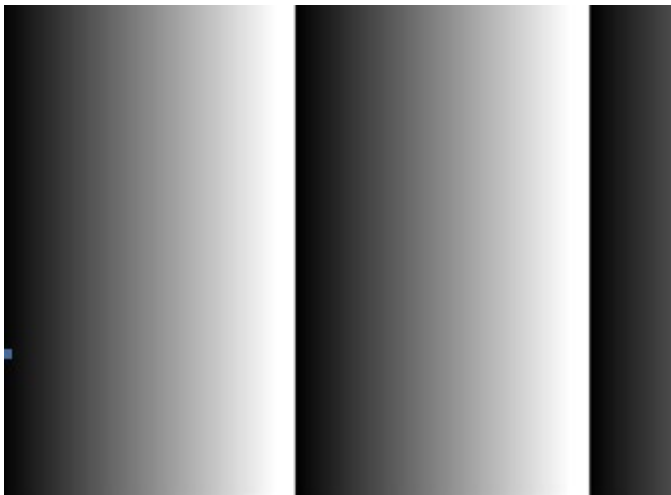

Figure 9-15 Grey Horizontal Ramp

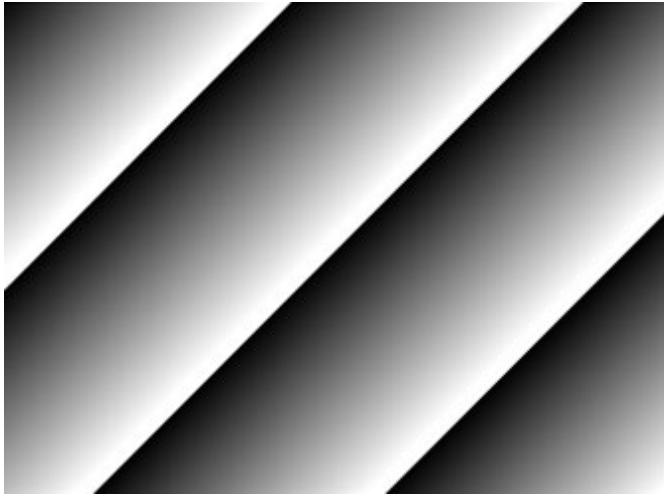

Figure 9-16 Grey Diagonal Ramp



Figure 9-17 Grey Diagonal Ramp Moving



**Caution!**

The test pattern may look different because the region of the test pattern may vary depending on the camera's resolution.

---

## 9.18 Reverse X

The Reverse X feature lets you flip images horizontally. This feature is available in all operation modes of the camera. The XML parameter related to Reverse X is as follows.

XML Parameters		Value	Description
ImageFormatControl	ReverseX	FALSE	Disables the Reverse X feature.
		TRUE	Flips images horizontally.

Table 9-24 XML Parameter related to Reverse X



Figure 9-18 Original Image

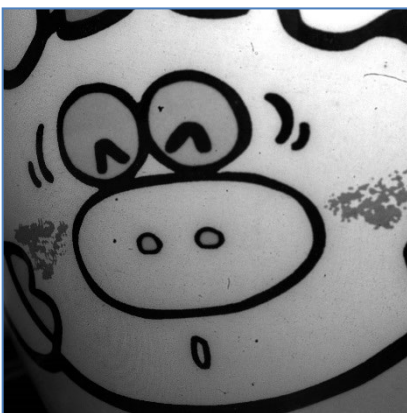

Figure 9-19 Reverse X Image



## 9.19 Device User ID

You can input user defined information up to 16 bytes.

The XML parameter related to Device User ID is as follows.

XML Parameters		Description
DeviceControl	DeviceUserID	Input user defined information (16 bytes).

Table 9-25 XML Parameter related to Device User ID

## 9.20 Device Reset

Resets the camera physically to power off and on. You must configure a link again because the camera will be released from the link between the camera and CXP Frame Grabber after reset.

The XML parameter related to Device Reset is as follows.

XML Parameters		Description
DeviceControl	DeviceReset	Resets the camera physically.

Table 9-26 XML Parameter related to Device Reset

## 9.21 Field Upgrade

The camera provides a feature to upgrade the Firmware and FPGA logic through the CoaXPress interface rather than disassemble the camera in the field. Refer to **Appendix B** for more details about how to upgrade.

## 9.22 User Set Control

You can save the current camera settings to the camera's internal Flash memory. You can also load the camera settings from the camera's internal Flash memory. The camera provides two setups to save and three setups to load settings. The XML parameters related to User Set Control are as follows.

XML Parameters	Value	Description	
UserSetControl	UserSetSelector	Default	Selects the Factory Default settings.
		UserSet1	Selects the UserSet1 settings.
		UserSet2	Selects the UserSet2 settings.
UserSetLoad	-	Loads the User Set specified by User Set Selector to the camera.	
UserSetSave	-	Saves the current settings to the User Set specified by User Set Selector. The Default is a Factory Default Settings and allowed to load only.	
UserSetDefault		Default	Applies the Factory Default settings when reset.
		UserSet1	Applies the UserSet1 settings when reset.
		UserSet2	Applies the UserSet2 settings when reset.

Table 9-27 XML Parameters related to User Set Control

The camera settings stored in the Default can be loaded into the camera’s workspace, but cannot be changed. The settings set in the workspace will be lost if the camera is reset or powered off. To use the current setting values in the workspace after a reset, you must save the settings to one of the user spaces.

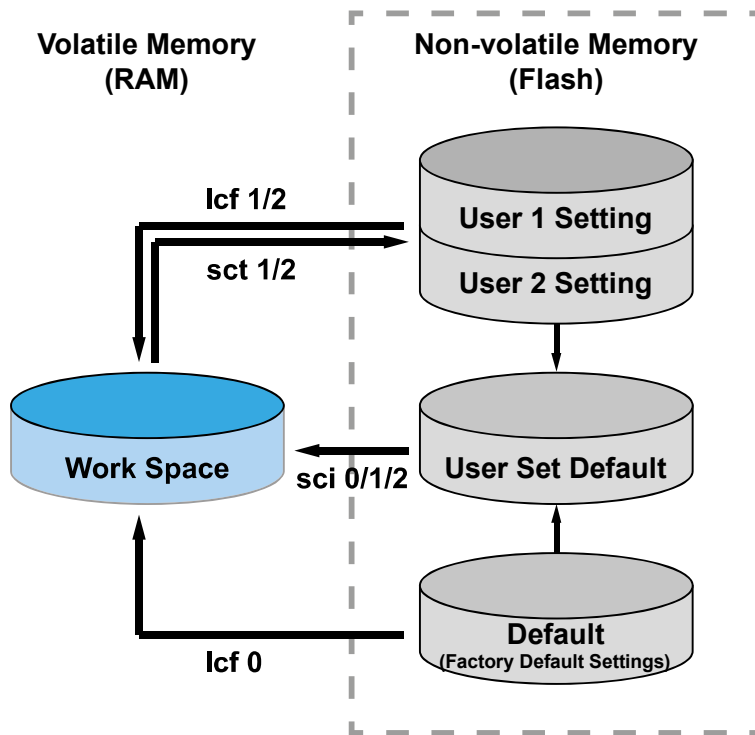

Figure 9-20 User Set Control

## 9.23 Sequencer Control

The Sequencer Control provided by the VC-101MX/151MX cameras allows you to apply different sets of parameter settings, called 'Sequencer Set', to a sequence of image acquisitions. As the camera acquires images, it applies one Sequencer Set after the other. This allows the camera to respond quickly to changing imaging requirements. For example, changes in illumination conditions influence the imaging requirements.

With the User Set Control feature, you can save user defined Sequencer Sets in the camera's non-volatile memory. Then after the camera is powered on or reset, the Sequencer Sets are available according to the **User Set Default** parameter. Each Sequencer Set is identified by an index number ranging from 0 to 31. Accordingly, you can define up to 32 different Sequencer Sets.

On the VC-101MX/151MX cameras, only the Flat Field correction data can be configured for Sequencer Sets. The XML parameters related to Sequencer Sets are as follows.

XML Parameters	Value	Description	
Sequencer Control	SequencerMode	Off	Disables the Sequencer.
		On	Enables the Sequencer.
	Sequencer ConfigurationMode	Off	Disables the Sequencer Configuration Mode.
		On	Enables the Sequencer Configuration Mode.
	SequencerSetSelector	0 ~ 31	Selects an index number of a Sequencer Set to be configured.
	SequencerSetActive	-	Displays the index number (0 ~ 31) of the Sequencer Set that is currently active.
	SequencerSetCount	1 ~ 32	Sets the number of Sequencer Sets to be applied.
	SequencerReset	-	Returns to Sequencer Set 0.

Table 9-28 XML Parameters related to Sequencer Control



### Caution!

To apply Sequencer Sets, you must set the Trigger Mode parameter to On.

### Use Case – Applying Four Different Flat Field Correction Data to Sequencer Sets

For example, assume that four different Flat Field correction data optimized for White, Green, Red and Blue pixels are applied to four different Sequencer Sets to inspect LCD panels.

1. Set the Sequencer Mode parameter to Off.
2. Set the Sequencer Configuration Mode parameter to On.
3. Set the Sequencer Set Selector parameter to 0 and set the Flat Field Data Selector parameter to 0. Then, set the Sequencer Set Selector parameter to 1, 2 and 3, and then set the Flat Field Data Selector parameter to 1, 2 and 3 respectively.
4. Set the Sequencer Set Count parameter to 4.
5. Set the Sequencer Configuration Mode parameter to Off, and then set the Sequencer Mode parameter to On.

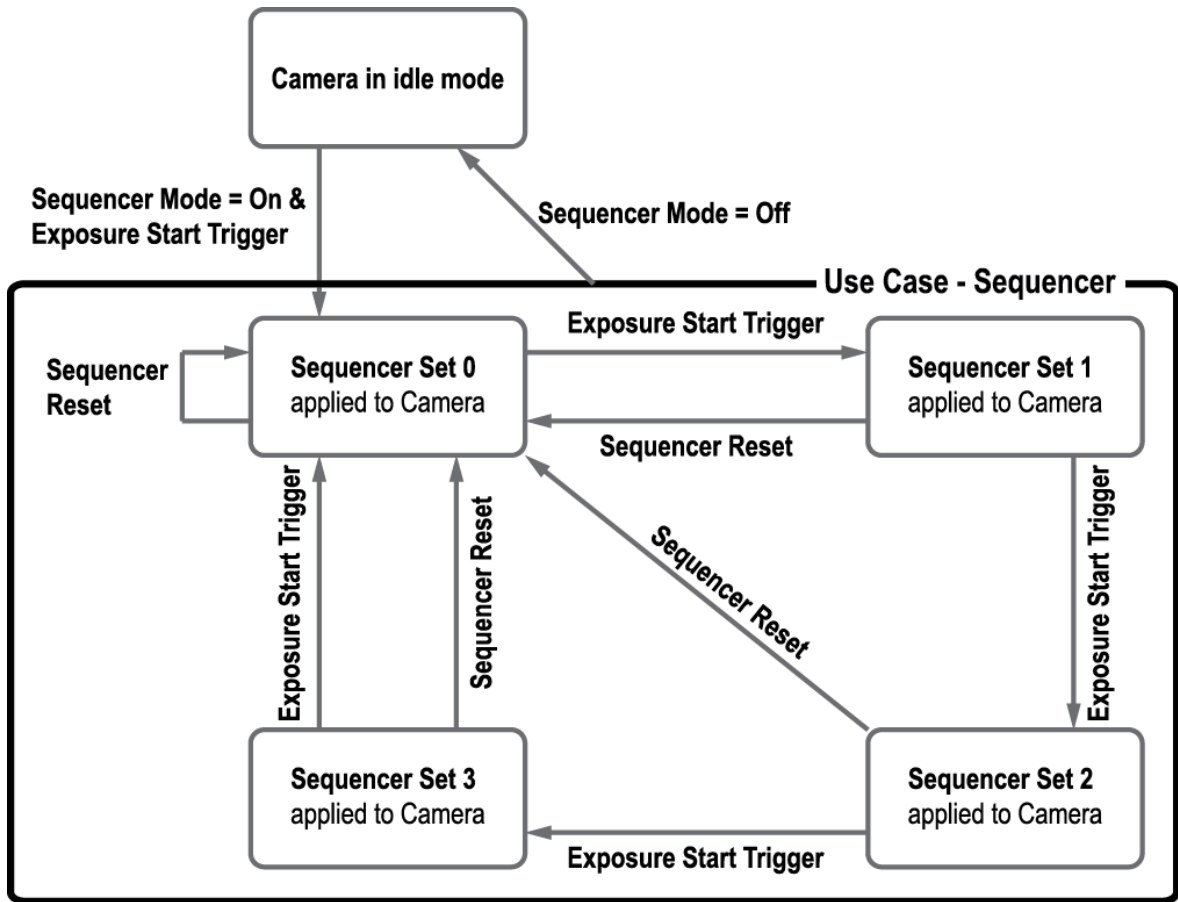

Figure 9-21 Sequencer Diagram (Use Case)



**Caution!**

- You can save the user defined Sequencer Sets in the camera's non-volatile memory by using the User Set Control feature. For more information, refer to 9.22 User Set Control.
- Executing the Sequencer Reset parameter allows to return to the Sequencer Set 0 status at any time while cycling through the Sequencer.

## Chapter 10. Troubleshooting

When you have a problem with a Vieworks camera, please check the following:

- If no image is displayed on your computer,
  - Ensure that all the cable connections are secure.
  - Ensure that the power supply is properly connected.
  - Ensure that trigger signals are applied correctly when you operate the camera with trigger signals.
- If images are not clear,
  - Ensure the camera lens or glass is clean.
  - Check the lens aperture is adjusted properly.
- If images are dark,
  - Ensure the camera lens is not blocked.
  - Check the exposure time is set properly.
  - Check the aperture is opened properly.
  - Check the Gain value is not set to small.
- If you identify abnormal operation or overheating sign,
  - Ensure the power supply is properly connected.
  - Stop using the camera when you notice smoke or abnormal overheating.
- If you have a problem using the Trigger Mode,
  - Ensure that the Software trigger related parameters are configured correctly.
  - Ensure that the trigger related parameters on you CXP Frame Grabber are configured correctly when you set the Trigger Source parameter to CXPIn.
  - Ensure that cable connections are secure when you set the Trigger Source parameter to Line0.
- If there is communication failure between the camera and computer,
  - Ensure coax cables are connected properly.
  - Ensure that you have configured a CXP Frame Grabber in your computer correctly and the camera is connected properly to the CXP Frame Grabber.





## Appendix A. Defective Pixel Map Download

1. Create the Defective Pixel Map data in Microsoft Excel format as shown in the left picture below and save as a CSV file (\*.csv). The picture in the right shows the created Excel file opened in Notepad. The following rules need to be applied when creating the file.

Lines beginning with ':' or '--' are treated as notes.

You must enter the horizontal value first and then vertical value for coordinates of each defect pixel.

Coordinate values for each pixel can be placed in any order.

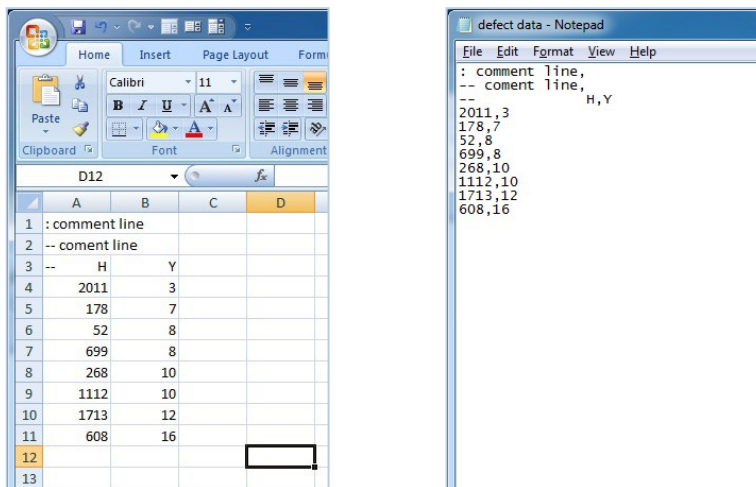

2. Run Vieworks Imaging Solution 7.X and click the **Configure** button to display the window as shown below. Select the **Defect** tab, click the File Path button, search and select the defective pixel map (\*.csv), and then click the **Download** button.

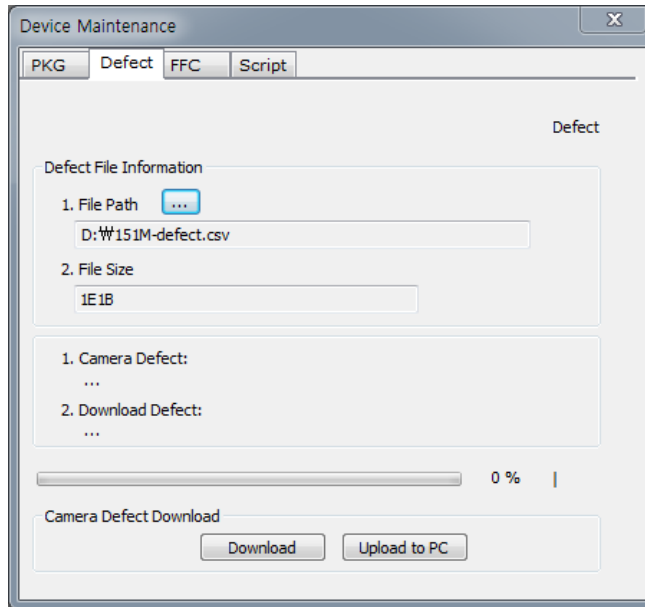

3. Once the download is complete, the saving process will begin. During the saving process, make sure not to disconnect the power cord.

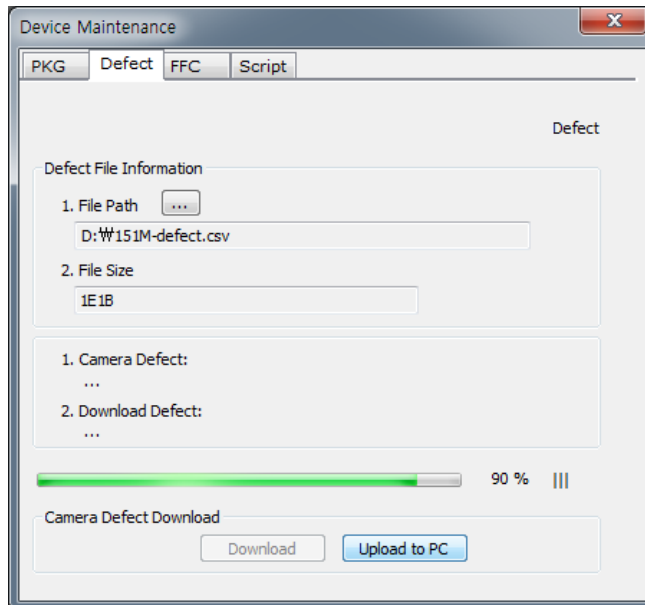

4. After completing the download, click the **OK** button to close the confirmation.

## Appendix B. Field Upgrade

You can upgrade the MCU, FPGA and XML file of the camera by following the procedures below.

1. Run Vieworks Imaging Solution 7.X and click the **Configure** button to display the window as shown below.
2. Select the **PKG** tab, click the File Path button, search and select the MCU, FPGA or XML upgrade file, and then click the **Download** button.

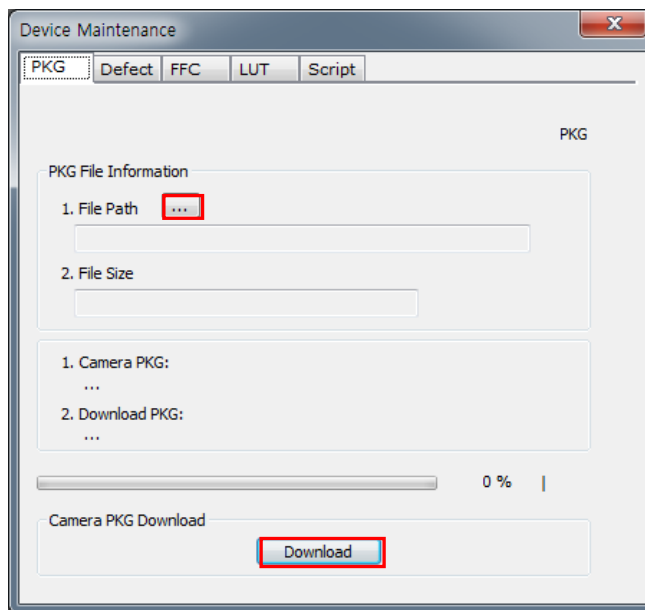

3. The camera begins downloading the upgrade file and the downloading status is displayed at the bottom of the window.

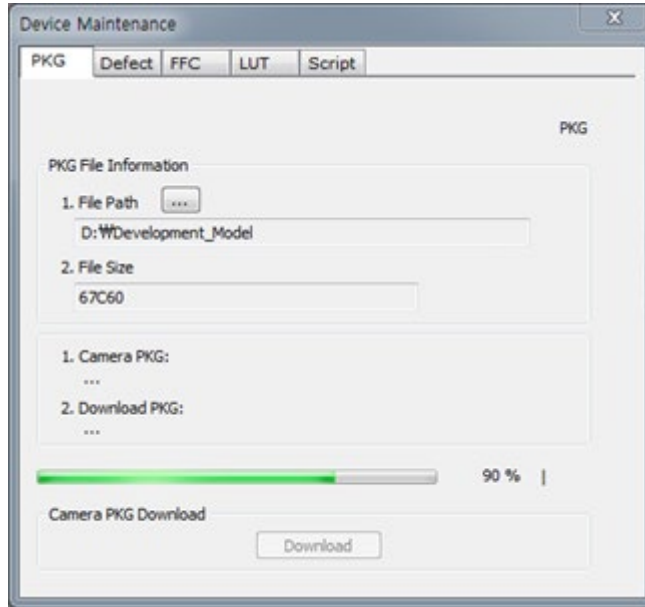

## Appendix C. Index

### 4

4-pin connector.....32

### 6

6-pin connector.....31

### A

acquisition control.....34

Acquisition Mode

    Continuous parameter.....34

Acquisition Mode parameter .....34

acquisition process.....48

Acquisition Start command.....34

Acquisition Stop command.....34

any edge.....39

### B

back panel.....28

Bayer RG 8/10/12/14/16.....59

block diagram .....19

### C

camera ON&OFF .....81

camera's pixel formats.....59

camera's temperature, parameters .....77

circuit .....33

Continuous parameter.....34

CXP connector ..... 28, 30

CXPin.....36

### D

diagram.....19

dimension .....24

downloading Vieworks Imaging Solution .....27

downloading VIS.....27

### E

Exposure Mode

    Timed.....36

    TriggerWidth .....36

Exposure Mode parameter .....36

**F**

falling edge .....	39
Flat Field Correction data, generation .....	66
frame acquisition process .....	48
Free-run.....	38

**G**

generating data of Flat Field correction.....	66
---	----

**H**

Hirose .....	31, 32
Hirose 4-pin connector .....	32
Hirose 6-pin connector .....	31

**I**

inputting information of user's choice .....	81
--	----

**K**

key features .....	17
--------------------	----

**L**

LED status.....	77
level high.....	39
level low .....	39
Line0.....	36

**M**

main features.....	17
mechanical dimension .....	24
Mono 8/10/12/14/16.....	59

**O**

overlapped exposure .....	48
---------------------------	----

**P**

pixel formats.....	59
preface.....	2, 4

**Q**

QE.....	20
quantum efficiency.....	20

**R**

reset physically .....	81
rising edge .....	39
ROI-origin position.....	54
ROI-size setting.....	54

**S**

schematic diagram .....33

Software .....36

specification.....18

spectral sensitivity .....20

strobe output .....33

**T**

tilt settings .....27

Timed .....36

trigger input .....33

Trigger Signals.....36

Trigger Source

    CXPin .....36

    Line0 .....36

    Software .....36

    UserOutput0.....36

Trigger Source parameter .....36

TriggerWidth .....36

TriggerWidth mode .....46

**U**

UserOutput0 .....36

**V**

VC-101MX specification ..... 18

VC-151MX specification ..... 18

Vieworks Imaging Solution ..... 4

Vieworks Imaging Solution download ..... 27

VIS .....4, 27

VIS installation ..... 27

**X**

XML parameter

    Analog Control.....62

    AnalogControl.....61

    BalanceRatio .....61

    BalanceRatioSelector.....61

    BalanceWhiteAuto .....61

    BlackLevel.....62

    BlackLevelSelector .....62

    CounterAndTimeControl.....75

    DataRoiControl .....60

    Debounce Time .....74

    DebounceTime .....71

    Device Reset .....81

    DeviceControl.....77

    DeviceTemperature.....77

    DeviceTemperatureSelector .....77

    DeviceUserID .....81

    DigitalIOControl .....71, 74

    DSNU Control.....63

    ExposureActive.....71

    FanOperationMode .....76

    FanSpeed.....76

    Flat Field Data Selector .....69

    FlatFieldControl.....67

    FlatFieldCorrection .....67

    FlatFieldDataGenerate.....67

    FlatFieldDataLoad .....67

    FlatFieldDataSave .....67

    FlatFieldDataSelector .....67

    FrameActive .....71

    Gain .....62

    GainSelector.....62

    GreyDiagonalRamp.....78

    GreyDiagonalRampMoving.....78

    GreyHorizontalRamp.....78

Height.....	54	SequencerSetCount.....	84
HeightMax.....	54	SequencerSetReset.....	84
Hot Pixel Correction.....	63	SequencerSetSelector.....	84
ImageFormatControl.....	54, 80	Strobe.....	71
Line 1.....	71	TargetTemperature.....	76
LineInverter.....	71	TestPattern.....	78
LineSelector.....	71	Timer0Active.....	71
LineSource.....	71	TimerDelay.....	75
OffsetX.....	54	TimerDuration.....	75
OffsetY.....	54	TimerReset.....	75
ReverseX.....	80	TimerTriggerActivation.....	75
RoiHeight.....	60	TimerTriggerSource.....	75
RoiOffsetX.....	60	UserDefault.....	82
RoiOffsetY.....	60	UserOutput0.....	71
RoiSelector.....	60	UserOutputValue.....	71
RoiWidth.....	60	UserSet1.....	82
SensorHeight.....	54	UserSet2.....	82
SensorSpecific.....	78	UserSetControl.....	82
SensorWidth.....	54	UserSetLoad.....	82
SequencerConfigurationMode.....	84	UserSetSave.....	82
SequencerControl.....	84	UserSetSelector.....	82
SequencerFeatureEnable.....	84	White Balance Auto.....	60
SequencerMode.....	84	Width.....	54
SequencerSetActive.....	84	WidthMax.....	54



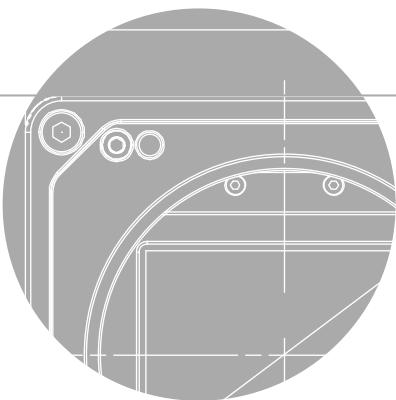
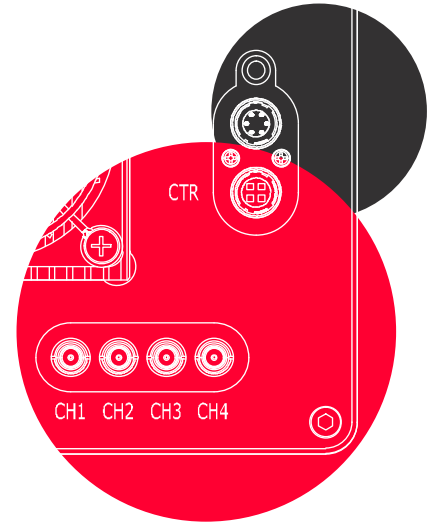
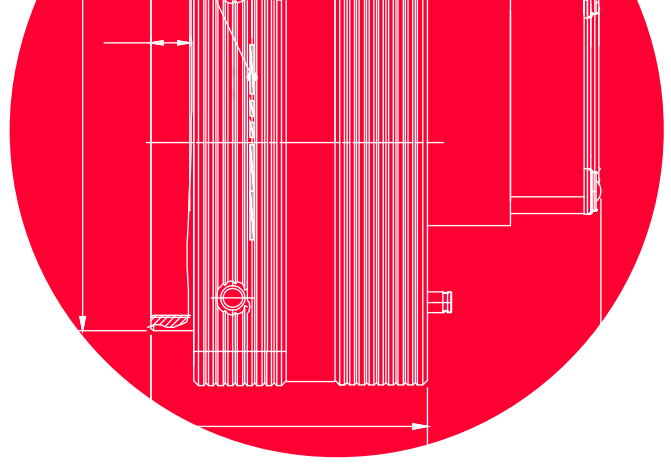

## Vieworks Co., Ltd.

41-3, Burim-ro, 170beon-gil,  
Dongan-gu, Anyang-si, Gyeonggi-do  
14055 Republic of Korea

Tel: +82-70-7011-6161

Fax: +82-31-386-8631

<http://vision.vieworks.com>

[vision@vieworks.com](mailto:vision@vieworks.com)