

VC series

User Manual

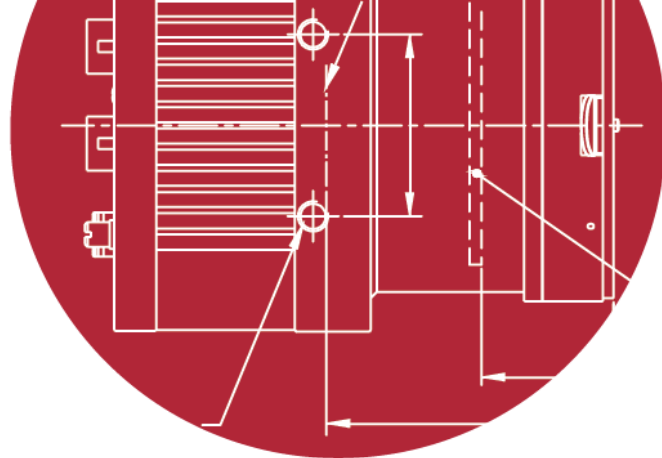

English

VC-2MC-M/C 150
VC-2MC-M/C 340
VC-3MC-M/C 280
VC-4MC-M/C 80
VC-4MC-M/C 180
VC-12MC-M/C 65
VC-25MC-M/C 30
VC-25MC-M/C 30 D

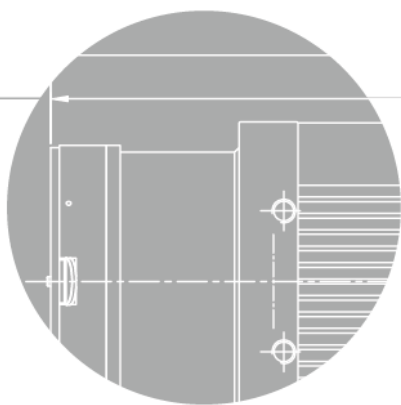

VIEWWORKS
Imaging Expert

Revision History

Revision	Date	Description
1.0	2010-10-01	Initial release
1.1	2010-12-13	Added 'scl' and 'gcl' command
1.2	2010-12-21	Added VC-2MC-M/C340 model
1.3	2011-04-07	Revised Max. Frame Rate
1.4	2011-07-12	Added 2 Tap and 4 Tap 10 bit
1.5	2011-10-25	<ul style="list-style-type: none"> • Added VC-2MC-150 and VC-4MC-80 • Added Camera Block Diagram description • Added Data Format • Added Defective Pixel Correction • Added Appendix A and B
1.6	2011-11-11	Added VC-4MC-40
1.7	2012-06-19	Added 8 Tap 10 bit data output to VC-2MC-340 and VC-4MC-180 models
1.8	2012-08-27	Revised the description of the Get Trigger Mode command
1.9	2012-10-15	<ul style="list-style-type: none"> • Changed the User Manual file name • Deleted VC-4MC-40 model • Added VC-3MC-280 model • Added VC-25MC-30 model
2.0	2013-06-14	<ul style="list-style-type: none"> • Added description of M5 set screws for tilt adjustment • Added Actual Time Applied for Commands
2.1	2013-09-09	<ul style="list-style-type: none"> • Added VC-12MC-65
2.2	2013-11-11	<ul style="list-style-type: none"> • Added 2 Tap and 4 Tap output mode to VC-12MC-65 • Revised the maximum FPS values depending on ROI Size of VC-2MC
2.3	2014-07-25	Added the maximum FPS values depending on ROI Size of VC-4MC
2.4	2014-09-19	Applied new CI
2.5	2015-04-30	Added the Flat Field Correction feature to VC-25MC-30
2.6	2015-06-19	Added the Flat Field Correction and HDR features to VC-2MC-340 and VC-4MC-180
2.7	2015-09-07	Changed the VC-25MC's mechanical dimension
2.8	2016-04-22	Added typical power requirements
2.9	2016-06-17	<ul style="list-style-type: none"> • Added the Multi-ROI feature (VC-25MC) • Added the Strobe Delay feature (VC-25MC) • Added the AWB feature (VC-25MC)

Revision	Date	Description
3.0	2017-03-24	Added the VC-25MC2-30 (PYTHON-25K)
3.1	2018-01-19	Added the Flat Field Selector feature to VC-12MC-65
3.2	2018-07-20	Added a note indicating the Strobe Offset (Strobe Delay) feature is only available on VC-25MC/VC-25MC2
3.3	2018-10-31	Changed the model name (VC-25MC2-M/C 30 → VC-25MC-M/C 30 D)
3.4	2019-04-05	Revised the frame rate and added features (Sequencer and FFC storage) to VC-25MC-M/C 30 D
3.5	2021-10-25	Corrected the explanation for the “High Dynamic Range (VC-2MC-M340/VC-4MC-M180 Only)” function
	2022-03-11	<ul style="list-style-type: none"> Corrected errors in the “How to Correct Dark Image using Configurator” section Corrected error of specification from 8 bit to 10 bit in the “Gain and Offset” section
3.6	2023-02-15	<ul style="list-style-type: none"> Added some contents related to UL certification

Contents

1	Precautions	7
2	Warranty	8
3	Compliance & Certifications	9
3.1	FCC Compliance	9
3.2	CE: DoC	9
3.3	KC	9
4	Package Components	10
5	Product Specifications	11
5.1	Overview.....	11
5.2	Specifications	12
5.3	Camera Block Diagram.....	15
5.4	Sensor Information	16
5.5	Mechanical Specification	21
6	Connecting the Camera	25
6.1	Mount Plate	25
6.2	Precaution to center the image sensor.....	26
6.3	Precaution about blurring compared to the center.....	26
6.4	Controlling the Camera	26
7	Camera Interface	27
7.1	General Description	27
7.2	Camera Link Connector	27
7.3	Power Input Connector	31
7.4	Control Connector.....	32
7.5	Trigger Input Circuit	33
7.6	Strobe Output Circuit	34
8	Camera Features	35
8.1	Region Of Interest (ROI).....	35
8.2	Multi-ROI (VC-12MC/VC-25MC Only).....	38
8.2.1	Multi-ROI on VC-12MC.....	38
8.2.2	Multi-ROI on VC-25MC.....	40
8.3	Binning (VC-25MC Monochrome Only).....	42
8.4	Exposure	43
8.4.1	Real Exposure (VC-12MC Only)	44

8.5	Trigger Mode	45
8.5.1	Free-Run Mode.....	45
8.5.2	External Sync Mode	46
8.5.3	Overlap Trigger Input.....	47
8.6	Camera Link Output.....	48
8.7	Gain and Offset.....	49
8.8	Defective Pixel Correction.....	50
8.8.1	Correction Method	50
8.9	Flat Field Correction (VC-2MC-340/VC-4MC-180/VC-12MC/VC-25MC Only).....	51
8.9.1	Sequence of Flat Field Correction	51
8.9.2	Flat Field Selector (VC-12MC/VC-25MC Only)	54
8.10	High Dynamic Range (VC-2MC-M340/VC-4MC-180 Only)	55
8.11	Sequencer for Multi-FFC (VC-25MC-30 D Only).....	56
8.12	Auto White Balance (VC-12MC/VC-25MC Only).....	58
8.13	Temperature Monitor.....	58
8.14	Status LED	58
8.15	Data Format.....	59
8.16	Test Image	60
8.17	Strobe.....	61
8.17.1	Strobe Offset (VC-25MC Only).....	61
8.17.2	Strobe Polarity	61
8.18	Field Upgrade	62
8.19	Dark Image Correction.....	63
8.19.1	Sequence of Dark Image Correction	63
8.20	White Pixel.....	64
9	Camera Configuration.....	65
9.1	Setup Command.....	65
9.2	Actual Time Applied for Commands	67
9.3	Parameter Storage Space	68
9.4	Command List	69

10	Configurator GUI	73
10.1	Camera Scan.....	73
10.2	Menu	74
10.2.1	File	74
10.2.2	Start-Up	75
10.2.3	Tool	76
10.2.4	About	77
10.3	Tab.....	78
10.3.1	VIEW tab.....	78
10.3.2	MODE/EXP Tap	80
10.3.3	ANALOG Tab	81
10.3.4	FFC Tab	82
11	Troubleshooting	83
Appendix A	Defective Pixel Map Download	84
Appendix B	Field Upgrade	87
B.1	MCU	87
B.2	FPGA.....	90

1 Precautions

General



- Do not drop, disassemble, repair or alter the device. Doing so may damage the camera electronics and cause an electric shock.
- Do not let children touch the device without supervision.
- Stop using the device and contact the nearest dealer or manufacturer for technical assistance if liquid such as water, drinks or chemicals gets into the device.
- Do not touch the device with wet hands. Doing so may cause an electric shock.
- Make sure that the temperature of the camera does not exceed the temperature range specified in [6.2 Specifications](#). Otherwise the device may be damaged by extreme temperatures.

Installation & Maintenance



- Do not install in dusty or dirty areas - or near an air conditioner or heater to reduce the risk of damage to the device.
- Avoid installing and operating in an extreme environment where vibration, heat, humidity, dust, strong magnetic fields, explosive/corrosive mists or gases are present.
- Do not apply excessive vibration and shock to the device. This may damage the device.
- Avoid direct exposure to a high intensity light source. This may damage the image sensor.
- Do not install the device under unstable lighting conditions. Severe lighting change will affect the quality of the image produced by the device.
- Do not use solvents or thinners to clean the surface of the device. This can damage the surface finish.

Power Supply



- Applying incorrect power can damage the camera. If the voltage applied to the camera is greater or less than the camera's nominal voltage, the camera may be damaged or operate erratically. Please refer to [6.2 Specifications](#) for the camera's nominal voltage.
 - ※ Vieworks Co., Ltd. does NOT provide power supplies with the devices.When using a Power Supply device, use a device below PS2 certified as UL 62368-1.
- Make sure the power is turned off before connecting the power cord to the camera. Otherwise, damage to the camera may result.

2 Before Using This Product

Thank you for choosing a camera in the VC Camera Link series.

- Make sure to read this manual before using the product.
- Make sure to check whatever a professional engineer has finished installation and configuration.
- Make sure to keep this manual at hand as a reference while using the product.
- This manual assumes that you have expertise in how to use an industrial camera.

2.1 The Series

This manual is intended for users of the following products:

- Products of the VC-2MC-M150E line
- Products of the VC-2MC-C150E line
- Products of the VC-2MC-M340E line
- Products of the VC-2MC-C340E line
- Products of the VC-3MC-M280D line
- Products of the VC-3MC-C280D line
- Products of the VC-4MC-M80E line
- Products of the VC-4MC-C80E line
- Products of the VC-4MC-M180E line
- Products of the VC-4MC-C180E line
- Products of the VC-12MC-M65E line including VC-12MC-M65E0
- Products of the VC-12MC-C65E line including VC-12MC-C65E0
- Products of the VC-25MC-M30 line
- Products of the VC-25MC-C30 line
- Products of the VC-25MC-M30D line
- Products of the VC-25MC-C30D line

3 Warranty

For information about the warranty, please contact your local dealer or factory representative.

4 Compliance & Certifications

4.1 FCC Compliance

This equipment has been tested and found to comply with the limits for a Class A digital device, pursuant to part 15 of the FCC Rules. These limits are designed to provide reasonable protection against harmful interference when the equipment is operated in a commercial environment. This equipment generates, uses, and can radiate radio frequency energy and, if not installed and used in accordance with the instruction manual, may cause harmful interference to radio communications. Operation of this equipment in a residential area is likely to cause harmful interference in which case the user will be required to correct the interference at own expenses.

4.2 CE: DoC

EMC Directive 2014/30/EU

EN 55032:2012 (Class A), EN 55024:2010

Class A

4.3 UL



This is the Canadian / US safety compliance mark applies to electric shock, fire and mechanical hazards.

In accordance with UL 62368-1.

* Among the products covered in this manual, only two models, VC-12MC-M65E0 and VC-12MC-C65E0, are UL certified.

4.4 KC

KCC Statement

Type	Description
Class A (Broadcasting Communication Device for Office Use)	This device obtained EMC registration for office use (Class A), and may be used in places other than home. Sellers and/or users need to take note of this.

5 Package Components

Package Components

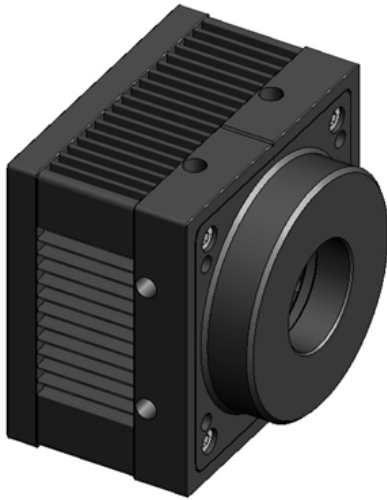

VC Camera <C-mount>



VC Camera <F-mount>



Mount Plate (Optional)



M5 Set Screws for Tilt Adjustment (Provided only with F-mount camera)



- You can adjust the tilt using the M5 set screws, however it is not recommended since it is adjusted as factory default settings.
- If the tilt settings need to be adjusted inevitably, please contact your local dealer or factory representative for technical support.

6 Product Specifications

6.1 Overview

VC Series is a high speed industrial area scan camera equipped with the latest global shutter CMOS image sensor. With its high reliability and durability, this camera is best suitable for machine vision requiring high-speed continuous shooting.

Main features

- High speed 2/3/4/12/25 megapixel CMOS image sensor
- Electronic exposure time control (global shutter)
- Output Pixel Format
 - VC-2MC / 4MC / 12MC / 25MC: 8 / 10 bit
 - VC-3MC: 8 bit
- Strobe Output
- Defective Pixel Correction
- Camera Link Output Mode
 - VC-2MC / 4MC / 12MC: 2 Tap, 4 Tap, 8 Tap, 10 Tap
 - VC-3MC / 25MC: 8 Tap, 10 Tap
- Gain/Offset Control
- Test Image
- LVDS (RS-644) serial communication by Camera Link interface
- Temperature monitor
- Field upgrade
- Dark image correction (Supported only on VC-2MC / 3MC / 4MC / 12MC)
- Flat Field Correction (VC-2MC-340 / VC-4MC-180 / VC-12MC-65 / VC-25MC-30 / VC-25MC-30 D Only)
- HDR (High Dynamic Range - VC-2MC-340 / VC-4MC-180 Only)

6.2 Specifications

Specifications for each VC camera model are as follows.

VC Series	VC-2MC-150	VC-2MC-340	VC-3MC-280
Resolution (H × V)	2048 × 1088		1696 × 1710
Sensor	CMOSIS CMV 2000		On Semiconductor LUPA 3000
Sensor Size	11.26 mm × 5.98 mm (Optical Format: 2/3")		13.57 mm × 13.68 mm (Optical Format: 1")
Sensor Type	High Speed Progressive Scan CMOS Image Sensor		
Pixel size	5.5 μm × 5.5 μm		8.0 μm × 8.0 μm
Interface	Camera Link		
Electronic Shutter	Global Shutter		
Max. Frame Rate	2 Tap: 74.4 fps		2 Tap: N/A
	4 Tap: 148.5 fps		4 Tap: N/A
	8 Tap: N/A	8 Tap: 295.4 fps	8 Tap: 227 fps
	10 Tap: N/A	10 Tap: 337.6 fps	10 Tap: 284 fps
Transfer Time	2 Tap: 13.44 ms		2 Tap: N/A
	4 Tap: 6.73 ms		4 Tap: N/A
	8 Tap: N/A	8 Tap: 3.38 ms	8 Tap: 4.41 ms
	10 Tap: N/A	10 Tap: 2.96 ms	10 Tap: 3.51 ms
Pixel Data Format	8 bit (2/4 Tap) 10 bit (2/4 Tap)	8 bit (2/4/8/10Tap) 10 bit (2/4/8 Tap)	8 bit (8/10Tap)
Camera Link Pixel Clock	85 MHz		
Exposure Time	1/100000 ~ 7 sec (10 μs step)		
Cable Length	< 5 m (Camera Link Cable at 85 MHz)		
Black Offset	0 ~ 63 LSB, 64 step		
Video Gain	0 ~ 12 dB, 64 step		
Trigger Mode	Free-Run, Trigger / Programmable Exposure Time and Trigger Polarity		
External Trigger	External, 3.3 V ~ 5.0 V Logical level input, Optically isolated		
Software Trigger	Camera Link CC1		
Dynamic Range	60 dB		
Lens Mount	C or F-mount		
Power	10 ~ 14 VDC, Typ. 4W	10 ~ 14 VDC, Typ. 4W	10 ~ 14 VDC, Typ. 5 W
Environmental	Operating: 0°C ~ 40°C, Storage: -40°C ~ 70°C		
Mechanical	68 mm × 68 mm × 54 mm, 373 g (with C-mount)		
Configuration SW	Configurator		

Table 6.1 Specifications of VC Series (VC-2MC / VC-3MC)

VC Series	VC-4MC-80	VC-4MC-180	VC-12MC-65
Resolution (H × V)	2048 × 2048		4096 × 3072
Sensor	CMOSIS CMV 4000		CMOSIS CMV 12000
Sensor Size	11.26 mm × 11.26 mm (Optical Format: 1")		22.5 mm × 16.9 mm (Diagonal: 28.14 mm)
Sensor Type	High Speed Progressive Scan CMOS Image Sensor		
Pixel size	5.5 μm × 5.5 μm		
Interface	Camera Link		
Electronic Shutter	Global Shutter		
Max. Frame Rate	2 Tap: 39.6 fps		2 Tap: 13.0 fps
	4 Tap: 78.9 fps		4 Tap: 26.0 fps
	8 Tap: N/A	8 Tap: 157.1 fps	8 Tap: 51.7 fps
	10 Tap: N/A	10 Tap: 179.5 fps	10 Tap: 64.3 fps
Transfer Time	2 Tap: 25.3 ms		2 Tap: 76.9 ms
	4 Tap: 12.67 ms		4 Tap: 38.5 ms
	8 Tap: N/A	8 Tap: 6.37 ms	8 Tap: 19.4 ms
	10 Tap: N/A	10 Tap: 5.58 ms	10 Tap: 15.6 ms
Pixel Data Format	8 bit (2/4 Tap)	8 bit (2/4/8/10Tap)	8 bit (2/4/8/10 Tap)
	10 bit (2/4 Tap)	10 bit (2/4/8 Tap)	10 bit (2/4/8 Tap)
Camera Link Pixel Clock	85 MHz		
Exposure Time	1/100000 ~ 7 sec (10 μs step)		5/100000~7sec (10 μs step)
Cable Length	< 5 m (Camera Link Cable at 85 MHz)		
Black Offset	0 ~ 63 LSB, 64 step		
Video Gain	0 ~ 12 dB, 64 step		
Trigger Mode	Free-Run, Trigger Programmable Exposure Time and Trigger Polarity		
External Trigger	External, 3.3 V ~ 5.0 V Logical level input, Optically isolated		
Software Trigger	Camera Link CC1		
Dynamic Range	60 dB		
Lens Mount	C or F-mount		F-mount
Power	10 ~ 14 VDC, Typ. 4 W	10 ~ 14 VDC, Typ. 4 W	10 ~ 14 VDC, Typ. 5 W
Environmental	Operating: 0°C ~ 40°C, Storage: -40°C ~ 70°C		
Mechanical	68 mm × 68 mm × 54 mm, 373 g (with C-mount)		68×68×80, 432g(F-mount)
Configuration SW	Configurator		

Table 6.2 Specifications of VC Series (VC-4MC / VC-12MC)

VC Series	VC-25MC-30	VC-25MC-30 D
Resolution (H × V)	5120 × 5120	
Sensor	On Semiconductor VITA-25K	On Semiconductor PYTHON-25K
Sensor Size	23.04 mm × 23.04 mm (Optical Format: 35 mm)	23.04 mm × 23.04 mm (Diagonal: 32.6 mm)
Sensor Type	High Speed Progressive Scan CMOS Image Sensor	
Pixel size	4.5 μm × 4.5 μm	
Interface	Camera Link	
Electronic Shutter	Global Shutter	
Max. Frame Rate	2 Tap: N/A	
	4 Tap: N/A	
	8 Tap: 25.0 fps	8 Tap: 25.3 fps
	10 Tap: 30.9 fps	10 Tap: 31.9 fps
Transfer Time	2 Tap: N/A	
	4 Tap: N/A	
	8 Tap: 40.00 ms	8 Tap: 39.52 ms
	10 Tap: 32.36 ms	10 Tap: 31.34 ms
Pixel Data Format	8 bit (8/10 Tap), 10 bit (8 Tap)	
Camera Link Pixel Clock	85 MHz	
Exposure Time	1/100000 ~ 7 sec (10 μs step)	
Cable Length	< 5 m (Camera Link Cable at 85 MHz)	
Black Offset	0 ~ 63 LSB, 64 step	
Video Gain	0 ~ 12 dB, 64 step	
Trigger Mode	Free-Run, Trigger Programmable Exposure Time and Trigger Polarity	
External Trigger	External, 3.3 V ~ 5.0 V Logical level input, Optically isolated	
Software Trigger	Camera Link CC1	
Dynamic Range	54 dB	59 dB
Lens Mount	F-mount	
Power	10 ~ 14 VDC, Typ. 6 W	10 ~ 14 VDC, Typ. 7 W
Environmental	Operating: 0°C ~ 40°C, Storage: -40°C ~ 70°C	
Mechanical	68 mm × 68 mm × 54 mm, 432 g (with F-mount)	
Configuration SW	Configurator	

Table 6.3 Specifications of VC Series (VC-25MC-30 / VC-25MC-30 D)

6.3 Camera Block Diagram

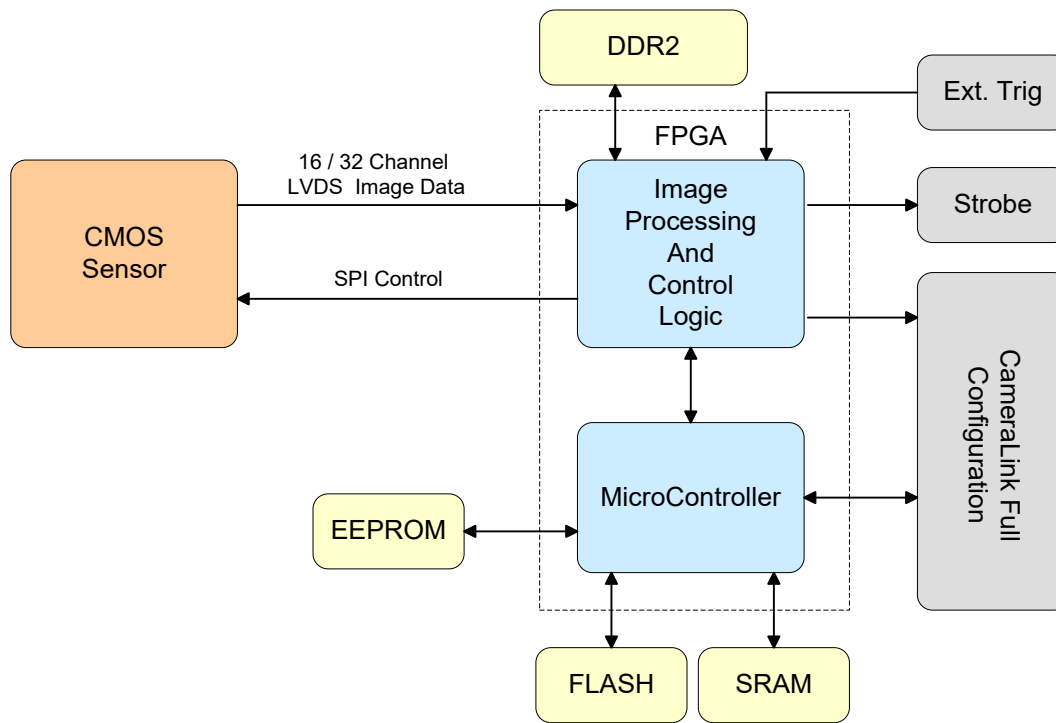

Figure 6-1 Camera Block Diagram

All controls and data processing of VC cameras are carried out in one FPGA chip. The FPGA generally consists of a 32 bit RISC Micro-Controller and Processing & Control Logic. The Micro-Controller receives commands from the user through the Camera Link interface and then processes them. The Processing & Control Logic processes the image data received from the CMOS sensor and then transmits data through the Camera Link interface. And also, the Processing & Control Logic controls the trigger inputs and strobe outputs which are sensitive to time. Furthermore, FLASH and DDR2 is installed outside FPGA. DDR2 is used to process images and FLASH contains the firmware that operates the Micro-Controller.

6.4 Sensor Information

The following graphs show the spectral response for VC-2MC monochrome and color camera.

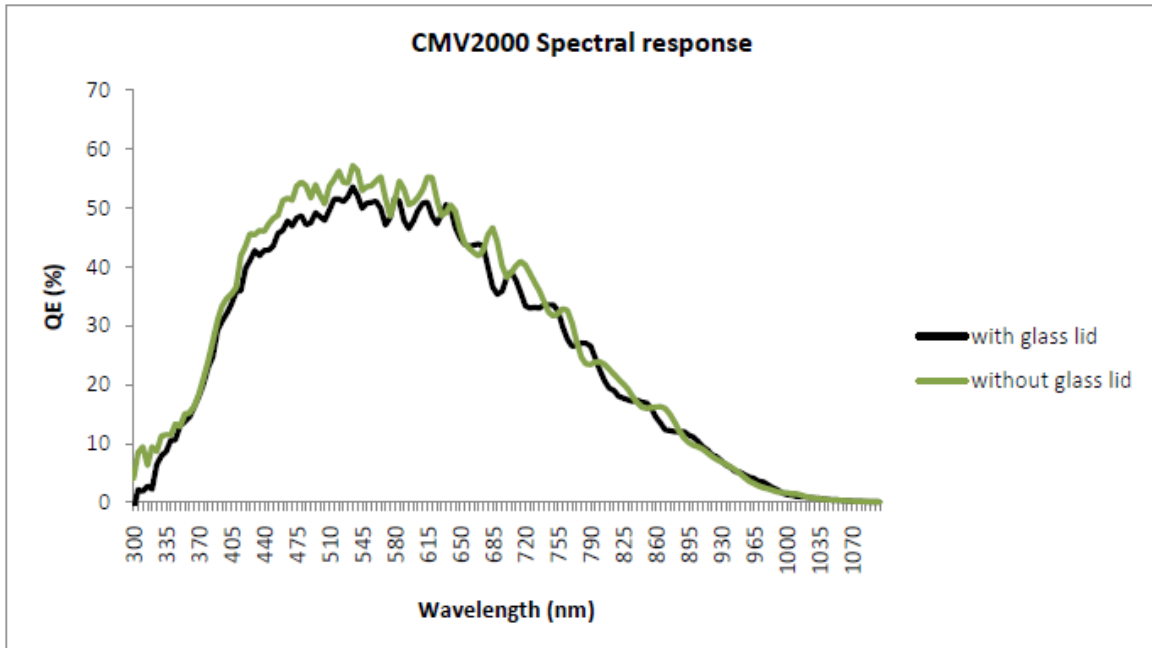

Figure 6-2 Mono Spectral Response for VC-2MC

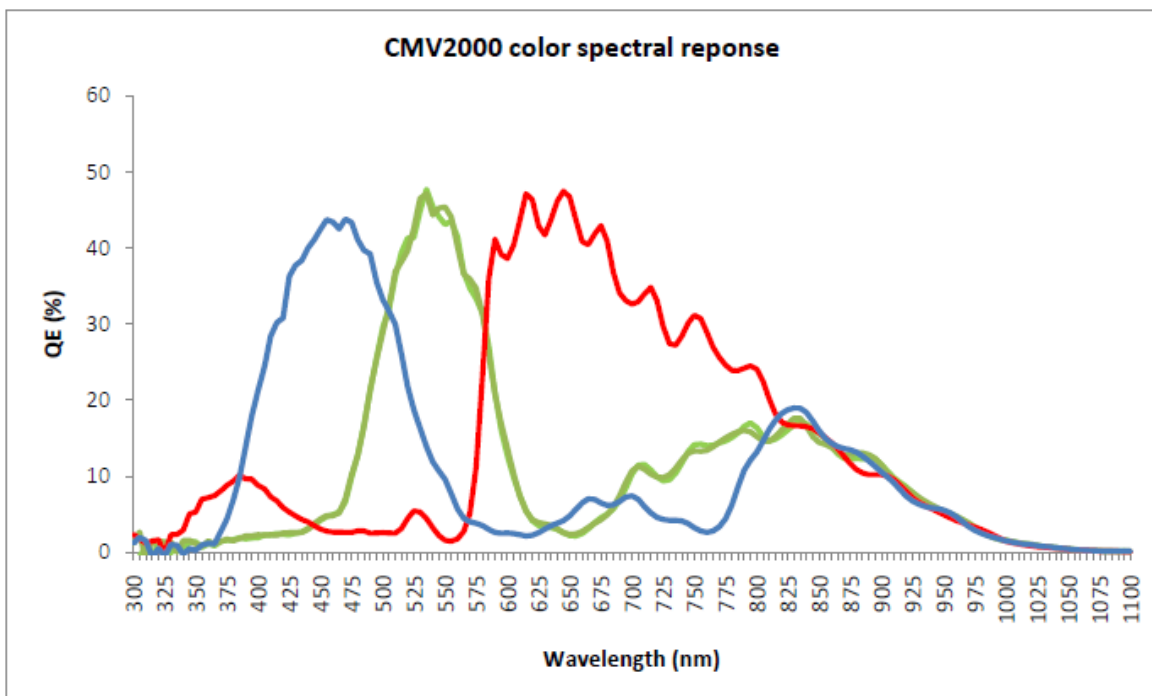

Figure 6-3 Color Spectral Response for VC-2MC

The following graph shows the spectral response for VC-3MC monochrome and color camera.

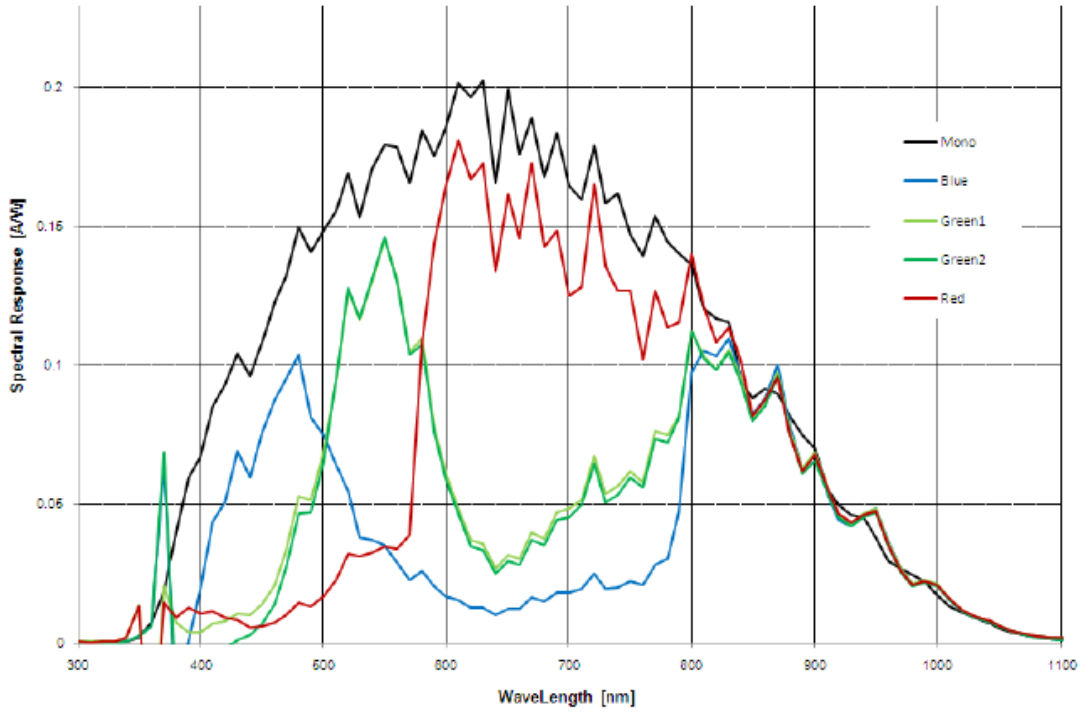

Figure 6-4 Mono and Color Spectral Response for VC-3MC

The following graphs show the spectral response for VC-4MC monochrome and color camera.

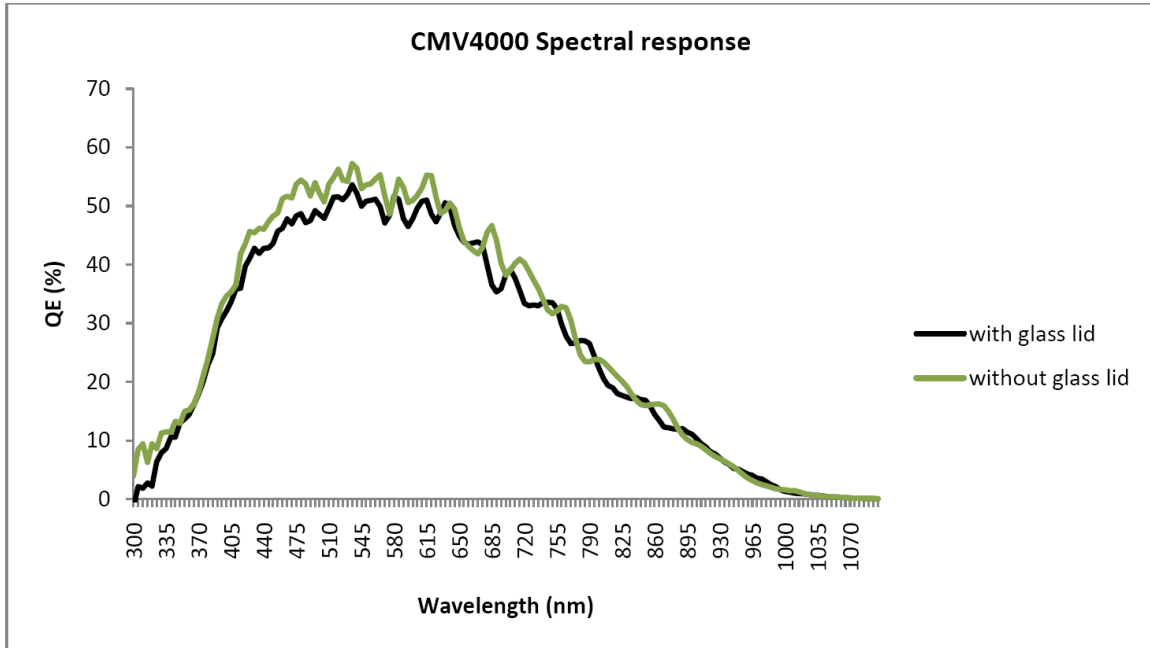

Figure 6-5 Mono Spectral Response for VC-4MC

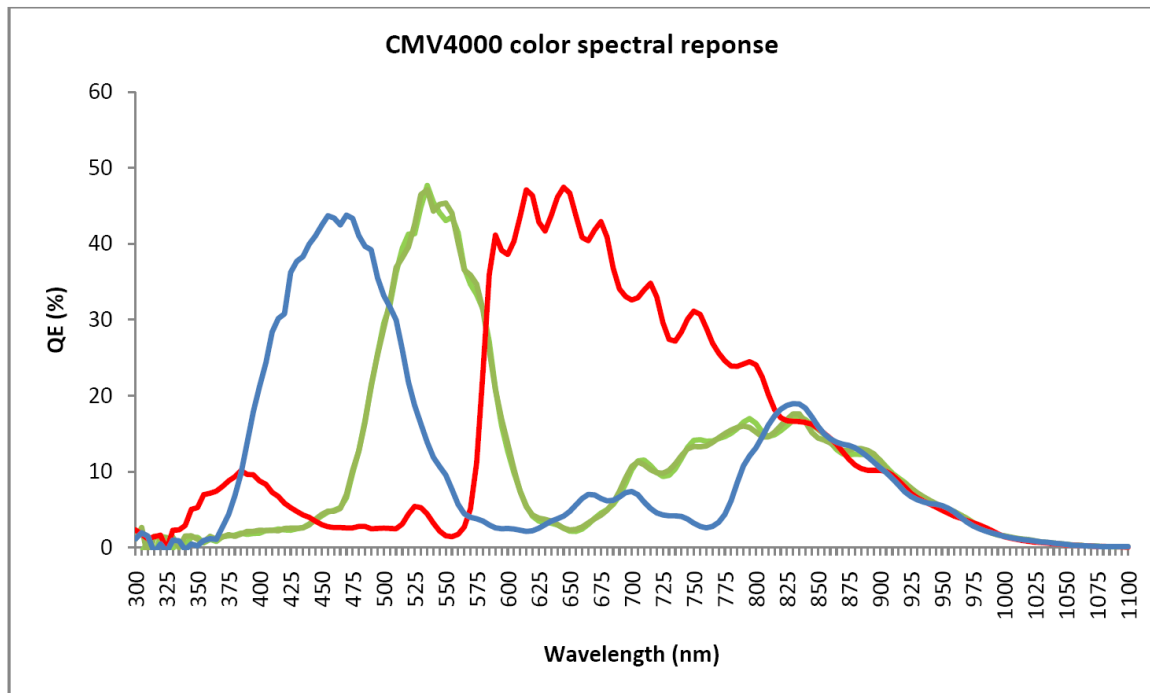

Figure 6-6 Color Spectral Response for VC-4MC

The following graph shows the spectral response for VC-12MC monochrome and color camera.

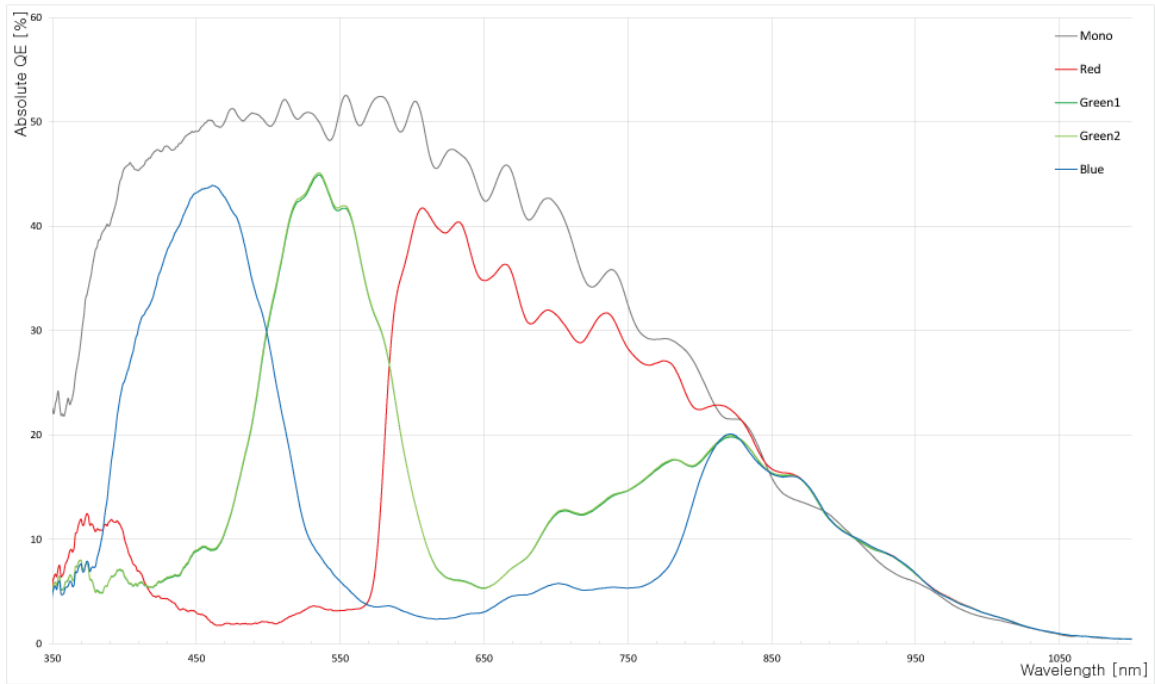

Figure 6-7 Mono and Color Spectral Response for VC-12MC

The following graph shows the spectral response for VC-25MC-30 monochrome and color camera.

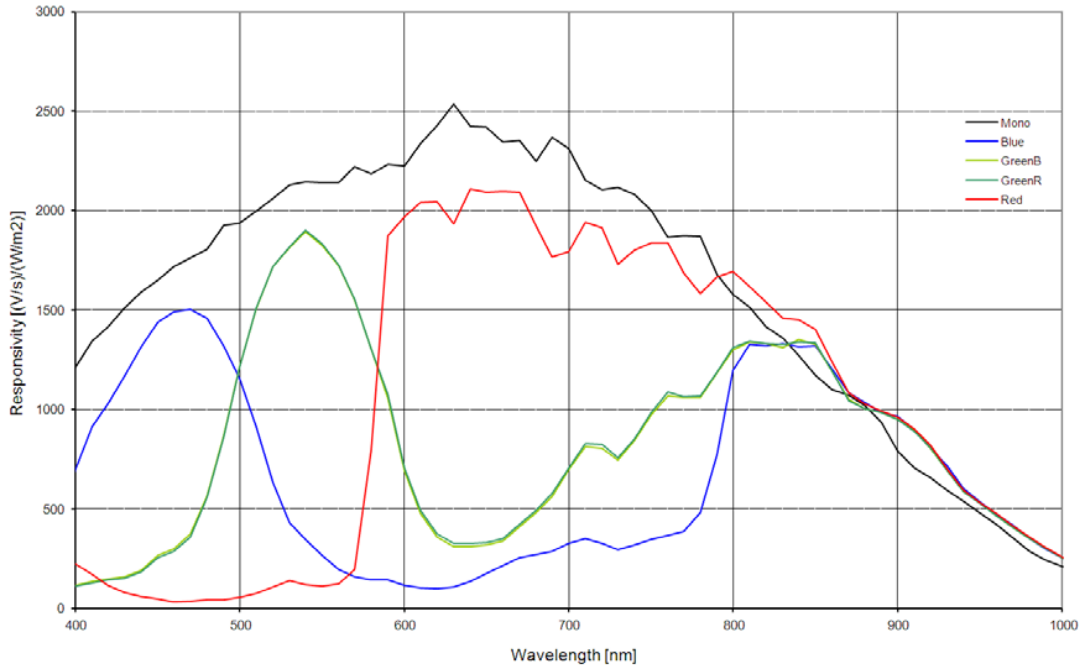

Figure 6-8 Mono and Color Spectral Response for VC-25MC-30

The following graph shows the spectral response for VC-25MC-30 D monochrome and color camera.

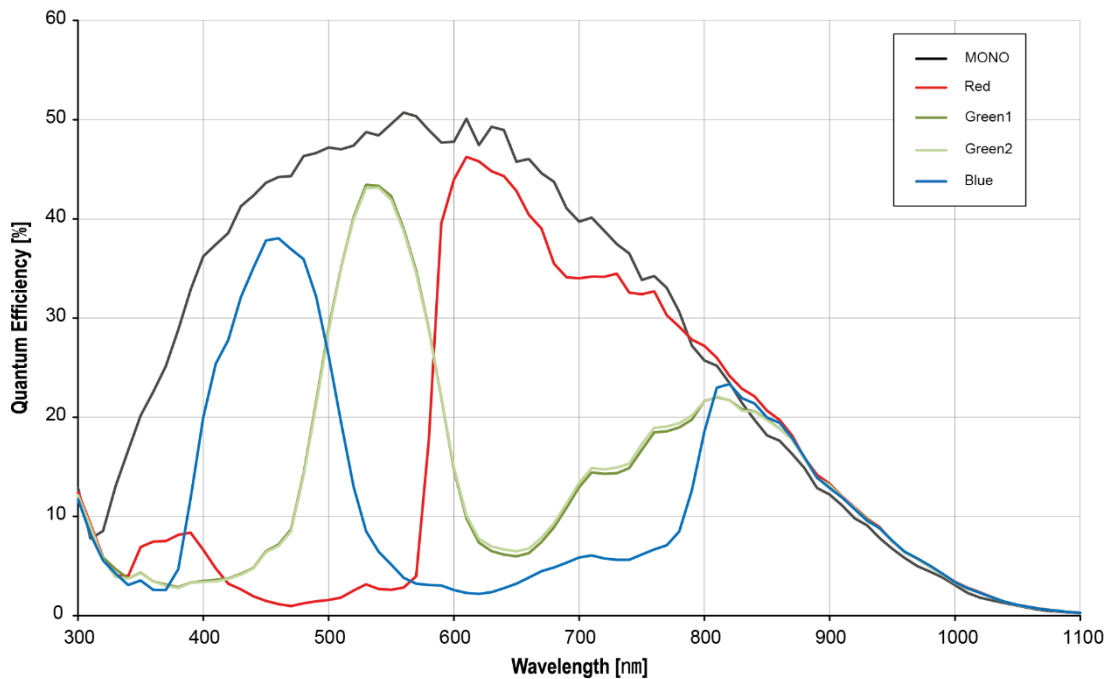

Figure 6-9 Mono and Color Spectral Response for VC-25MC-30 D

6.5 Mechanical Specification

The camera dimensions in millimeters are as shown in the following figures.

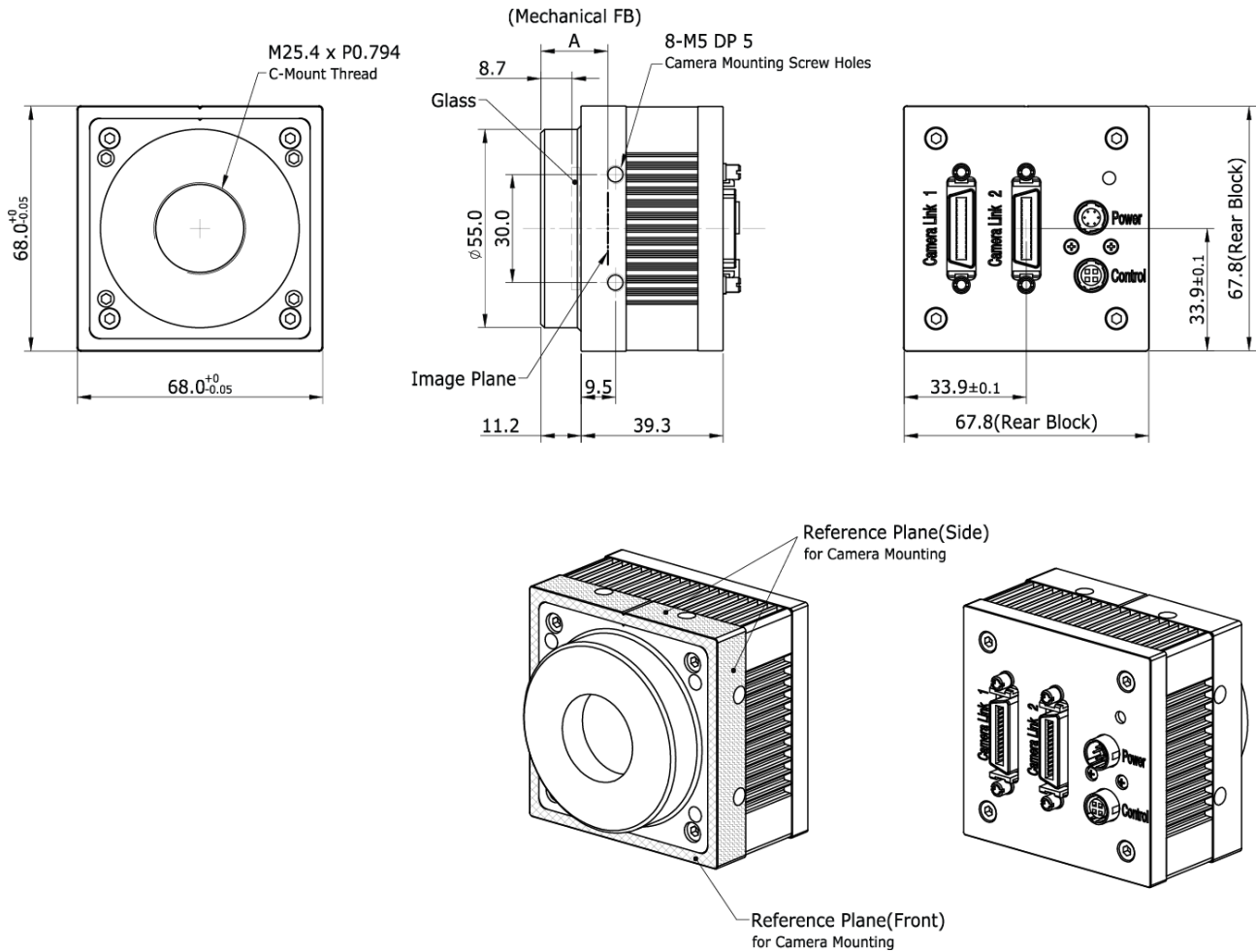

Figure 6-10 VC-2MC / 3MC / 4MC Camera Link C-mount Mechanical Dimension

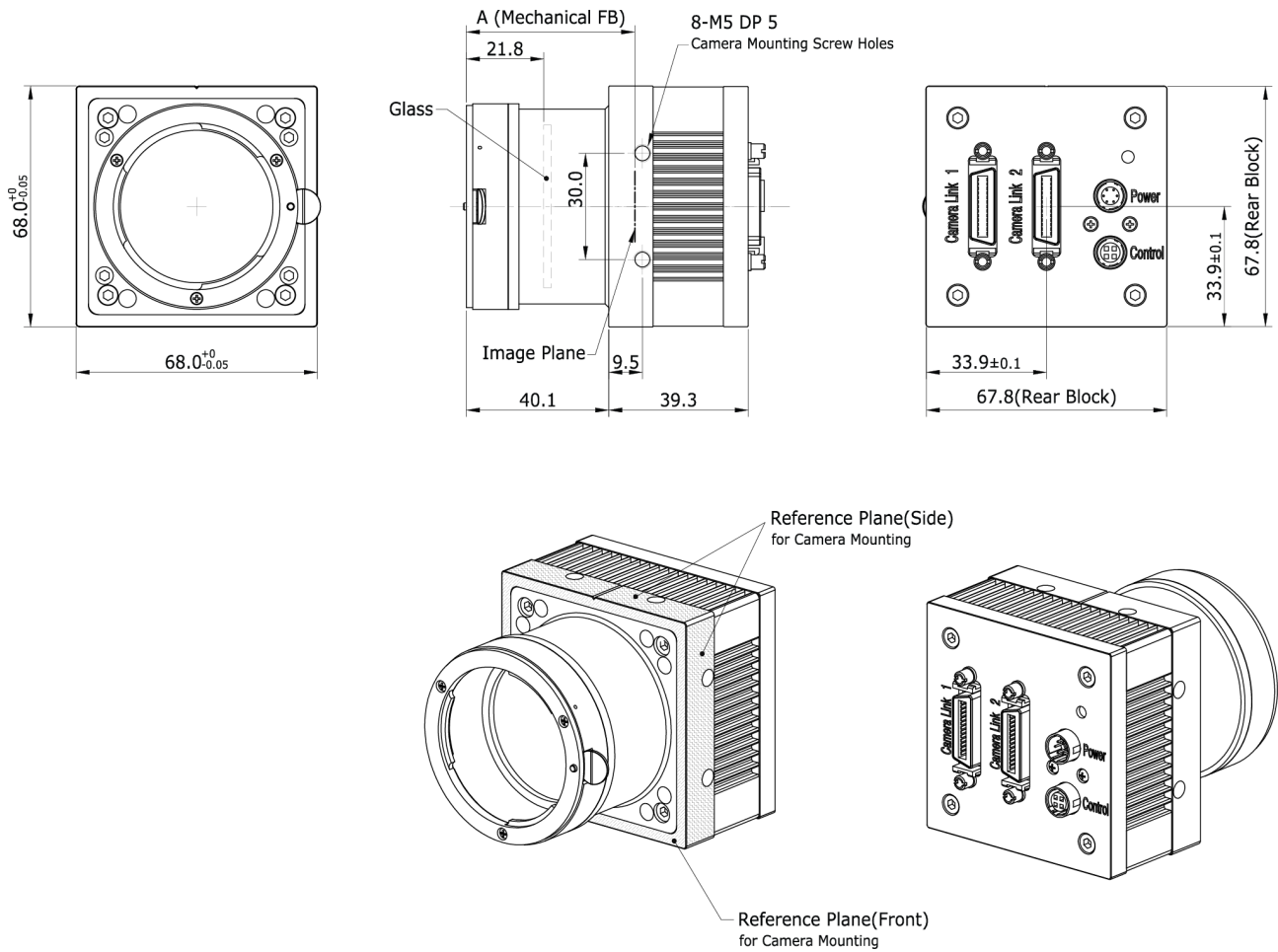

Figure 6-11 VC-2MC / 3MC / 4MC Camera Link F-mount Mechanical Dimension

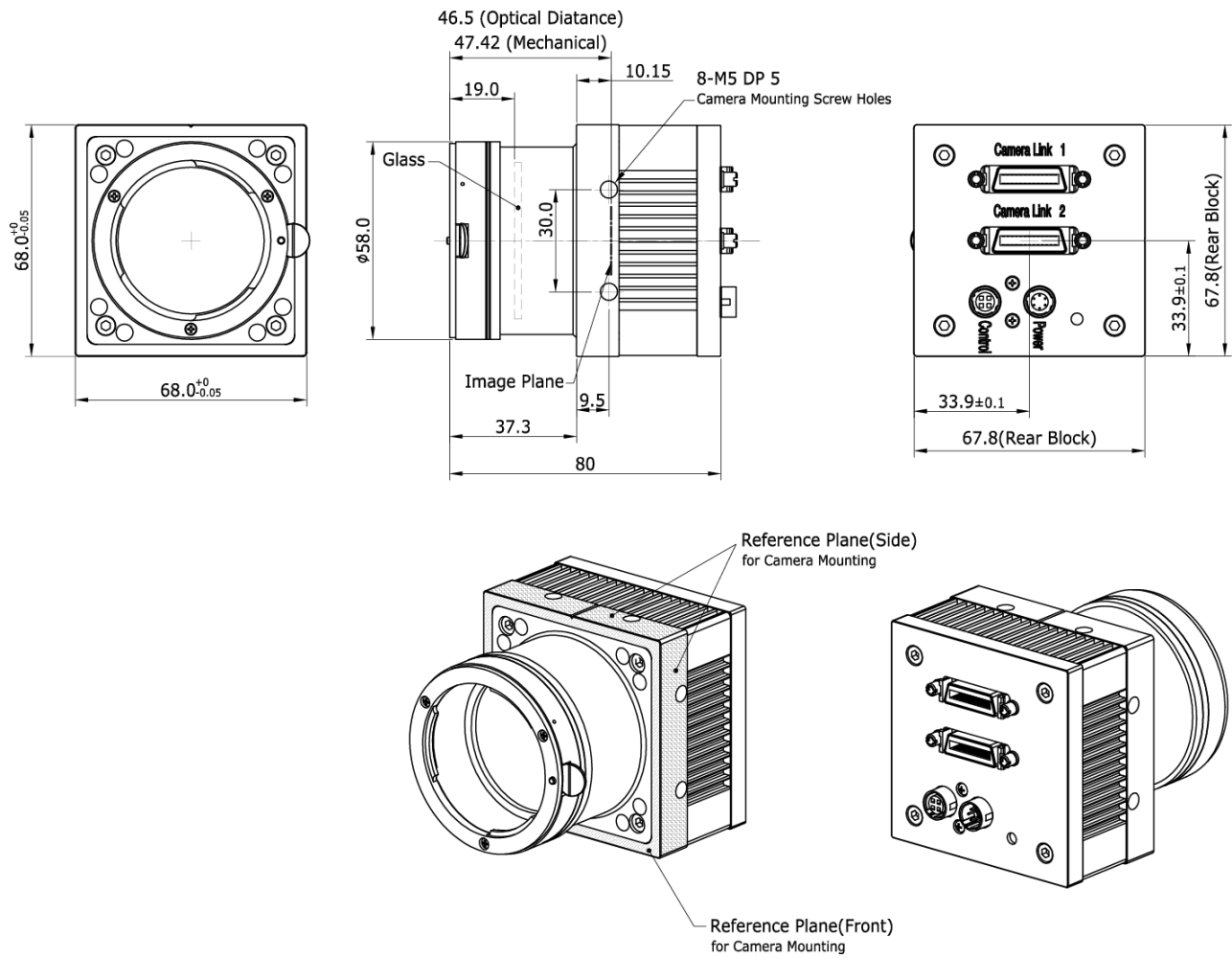

Figure 6-12 VC-12MC / 25MC Camera Link F-mount Mechanical Dimension

6.5.1 Camera Mounting and Heat Dissipation

You must mount the camera on a heat dissipation structure to maintain the temperature of the camera housing at 50°C or less. Given the low power consumption of the VC Camera Link series camera, its housing temperature during operation will generally stay within the specified limits. However, overheating can occur if heat dissipation is restricted or if the camera is mounted on a severe environment. It is recommended to follow the general guidelines below when you mount the camera.

- In all cases, you should monitor the temperature of the camera housing and make sure that the temperature does not exceed 50°C. You can monitor the internal temperature of the camera by using the Device Temperature parameter.
- If your camera is mounted on a metal component in your system, this may provide sufficient heat dissipation.

6.5.2 Fixing the Camera

If needed, it enables to fix the VC Camera Link series product firmly to use. When doing this, the sections available to be used for tightening by the setscrews are 8 parts marked with the dashed lines in the following figure:

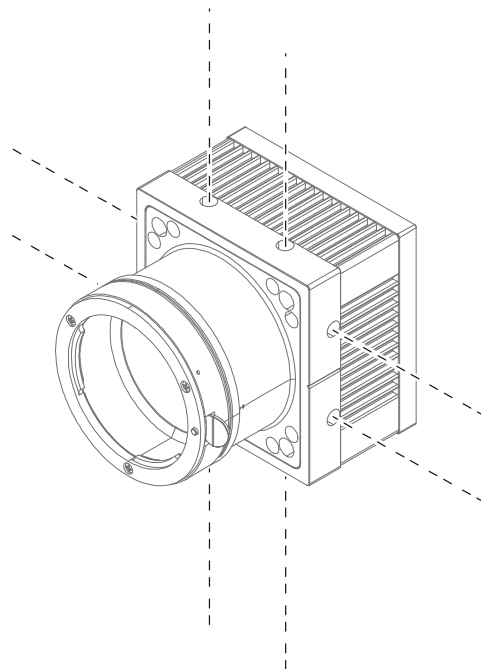

Figure 6-13 Locations available to Tighten the Setscrews when Mounting the Product

At least one of the four surfaces must be fixed, and at this time, all two setscrews must be fastened on one surface. For this product, the type of the fixing setscrew is M5, and this setscrew must be screwed into the camera by at least 4 mm.

7 Connecting the Camera

The following instructions assume that you have installed a Camera Link frame grabber in your PC including related software. For more information, refer to your Camera Link frame grabber User Manual.

To connect the camera to your PC, follow the steps below:

1. Make sure that the power supply is not connected to the camera and your PC is turned off.
2. Plug one end of a Camera Link cable into the Camera Link connector on the camera and the other end of the Camera Link cable into the connector on your Camera Link frame grabber.
3. Connect the plug of the power adaptor to the power input connector on the camera.
4. Plug the power adaptor into a working electrical outlet.
5. Verify that all the cable connections are secure.

7.1 Mount Plate

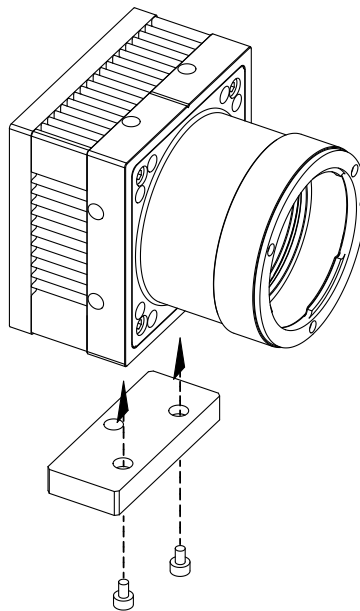

- The Mount Plate is provided as an optional item.
- The camera can be fixed without using this Mount Plate.

7.2 Precaution to center the image sensor

- User does not need to center the image sensor as it is adjusted as factory default settings.
- When you need to adjust the center of image sensor, please contact your local dealer or the manufacturer for technical assistance.

7.3 Precaution about blurring compared to the center

- User does not need to adjust the tilt as it is adjusted as factory default settings.
- If the tilt settings need to be adjusted inevitably, please contact your local dealer or factory representative for technical support.

7.4 Controlling the Camera

- You can control the camera by executing the Configurator.exe file.
- You can download the latest Configurator at <http://vision.viewworks.com>.
- Please refer to your Camera Link frame grabber user manual.

8 Camera Interface

8.1 General Description

As shown in the following figure, 4 types of connectors and status indicator LED are located on the back of the camera and have the functions as follows:

- ① 26 pin Camera Link Connector 1 (Base): controls video data transmission and the camera.
- ② 26 pin Camera Link Connector 2 (Medium/Full): transmits video data
- ③ Status LED: displays power status and operation mode.
- ④ 6 pin Power Input Connector: supplies power to the camera.
- ⑤ 4 pin Control Connector: inputs external trigger signal and outputs strobe.

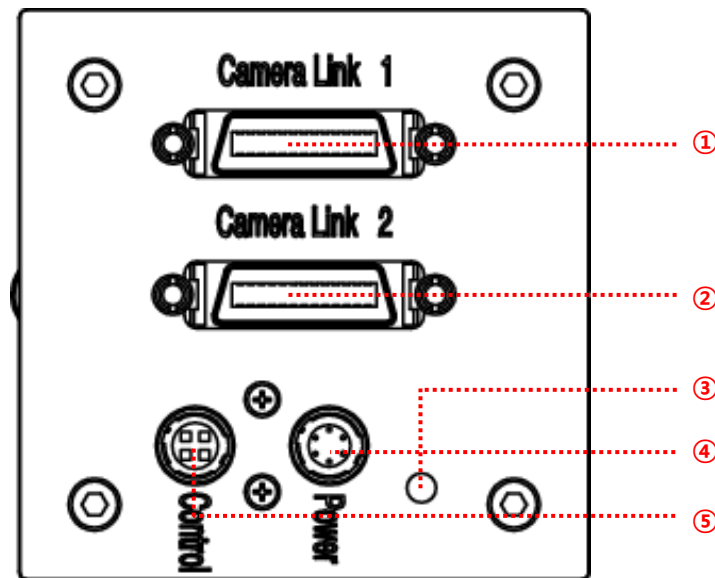

Figure 8-1 VC Series Back Panel

8.2 Camera Link Connector

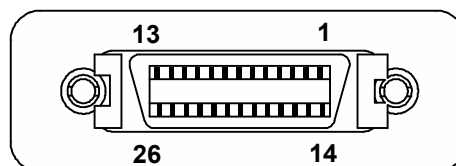

Figure 8-2 Camera Link Connector

Camera output complies with Camera Link Standard and the following list shows the pin configuration of the connector.

PAIR List	Pin	Signal Name	Type	Description
PAIR 0	1	Ground	Ground	Cable Shield
	14	Ground	Ground	Cable Shield
PAIR 1	2	-X0	LVDS - Out	Camera Link Transmitter
	15	+X0	LVDS - Out	Camera Link Transmitter
PAIR 2	3	-X1	LVDS - Out	Camera Link Transmitter
	16	+X1	LVDS - Out	Camera Link Transmitter
PAIR 3	4	-X2	LVDS - Out	Camera Link Transmitter
	17	+X2	LVDS - Out	Camera Link Transmitter
PAIR 4	5	-XCLK	LVDS - Out	Camera Link Transmitter
	18	+XCLK	LVDS - Out	Camera Link Transmitter
PAIR 5	6	-X3	LVDS - Out	Camera Link Transmitter
	19	+X3	LVDS - Out	Camera Link Transmitter
PAIR 6	7	+ SerTC	LVDS - In	Serial Data Receiver
	20	- SerTC	LVDS - In	Serial Data Receiver
PAIR 7	8	- SerTFG	LVDS - Out	Serial Data Transmitter
	21	+ SerTFG	LVDS - Out	Serial Data Transmitter
PAIR 8	9	- CC 1	LVDS - In	Software External Trigger
	22	+ CC 1	LVDS - In	Software External Trigger
PAIR 9	10	N/C	N/C	N/C
	23	N/C	N/C	N/C
PAIR 10	11	N/C	N/C	N/C
	24	N/C	N/C	N/C
PAIR 11	12	N/C	N/C	N/C
	25	N/C	N/C	N/C
PAIR 12	13	Ground	Ground	Cable Shield
	26	Ground	Ground	Cable Shield

Table 8.1 Pin Assignments for Camera Link Connector 1

PAIR List	Pin	Signal Name	Type	Description
PAIR 0	1	Ground	Ground	Cable Shield
	14	Ground	Ground	Cable Shield
PAIR 1	2	-Y0	LVDS - Out	Camera Link Transmitter
	15	+Y0	LVDS - Out	Camera Link Transmitter
PAIR 2	3	-Y1	LVDS - Out	Camera Link Transmitter
	16	+Y1	LVDS - Out	Camera Link Transmitter
PAIR 3	4	-Y2	LVDS - Out	Camera Link Transmitter
	17	+Y2	LVDS - Out	Camera Link Transmitter
PAIR 4	5	-YCLK	LVDS - Out	Camera Link Transmitter
	18	+YCLK	LVDS - Out	Camera Link Clock Tx
PAIR 5	6	-Y3	LVDS - Out	Camera Link Channel Tx
	19	+Y3	LVDS - Out	Camera Link Channel Tx
PAIR 6	7	-	Not Used	Connected with 100 ohm
	20	-	Not Used	
PAIR 7	8	-Z0	LVDS - Out	Camera Link Transmitter
	21	+Z0	LVDS - Out	Camera Link Transmitter
PAIR 8	9	-Z1	LVDS - Out	Camera Link Transmitter
	22	+Z1	LVDS - Out	Camera Link Transmitter
PAIR 9	10	-Z2	LVDS - Out	Camera Link Transmitter
	23	+Z2	LVDS - Out	Camera Link Transmitter
PAIR 10	11	-ZCLK	LVDS - Out	Camera Link Transmitter
	24	+ZCLK	LVDS - Out	Camera Link Clock Tx
PAIR 11	12	-Z3	LVDS - Out	Camera Link Channel Tx
	25	+Z3	LVDS - Out	Camera Link Channel Tx
PAIR 12	13	Ground	Ground	Cable Shield
	26	Ground	Ground	Cable Shield

Table 8.2 Pin Assignments for Camera Link Connector 2

Model	Camera Link Output Mode	CL Configuration	CL Connector 1	CL Connector 2
VC-2MC-340	2 Tap	BASE	O	X
	4 Tap	MEDIUM	O	O
VC-4MC-180	8 Tap	FULL	O	O
	10 Tap	FULL	O	O
VC-12MC-65	8 Tap	FULL	O	O
VC-3MC-280	8 Tap	FULL	O	O
VC-25MC-30	10 Tap	FULL	O	O
VC-25MC-30 D				

Table 8.3 Connector Arrangement for Camera Link Output Modes



When you connect a Frame Grabber to Camera Link Connectors using Camera Link cables, make sure you connect to the correct Camera Link Connector. Incorrect connection of Connector 1 and Connector 2 may cause malfunction of the camera or communication problems between PC and the camera.

8.3 Power Input Connector

The power input connector is a Hirose 6 pin connector (part # HR10A-7R-6PB). Pin arrangement and configuration are as follows:

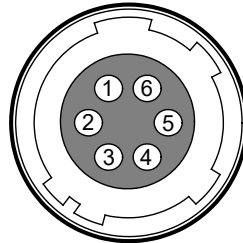

Figure 8-3 Pin Arrangement of Power Input Connector

Pin Number	Signal	Type	Description
1, 2, 3	+ 12 VDC	Input	DC Power Input
4, 5, 6	DC Ground	Input	DC Ground

Table 8.4 Pin Configuration of Power Input Connector

Connecting the power cable to the camera can be made by using the Hirose 6 pin plug (part # HR10A-7P-6S) or the equivalent. The power adaptor is recommended to have at least 1A current output at 12 VDC \pm 10% voltage output.

(Users need to purchase the power adaptor separately. When using a Power Supply device, use a device below PS2 certified as UL 62368-1.)

Precaution for Power Input



- Make sure the power is turned off before connecting the power cord to the camera. Otherwise, damage to the camera may result.
- If the voltage applied to the camera is greater than specified in the specifications, damage to the camera may result.

8.4 Control Connector

The control connector is a Hirose 4 pin connector (part # HR10A-7R-4S) and consists of an external trigger signal input and strobe output port. Pin arrangement and configuration are as follows:

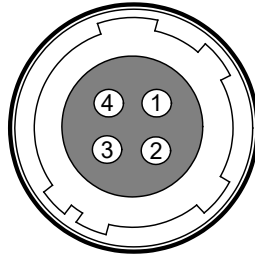

Figure 8-4 Pin Arrangement of Control Connector

Pin Number	Signal	Type	Description
1	Trigger Input +	Input	-
2	Trigger Input -	Input	-
3	DC Ground	-	DC Ground
4	Strobe Out	Output	3.3 V TTL Output Output resistance: 47 Ω

Table 8.5 Pin Configuration of Control Connector

The mating connector is a Hirose 4 pin plug (part # HR10A-7P-4P) or the equivalent connectors.

8.5 Trigger Input Circuit

Following figure shows trigger signal input circuit of the 4-pin connector. Transmitted trigger signal is applied to the internal circuit through a photo coupler. Minimum trigger width that can be recognized by the camera is 1 μ s. If transmitted trigger signal is less than 1 μ s, the camera will ignore the trigger signal. External trigger circuit example is shown below.

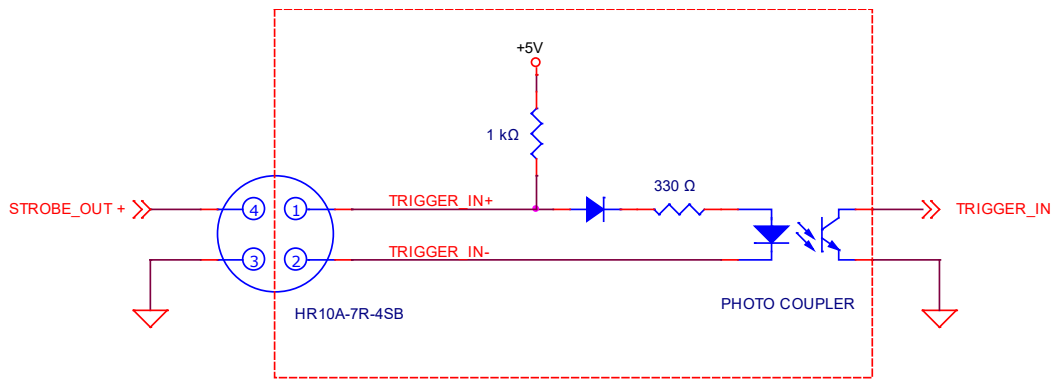

Figure 8-5 Trigger Input Schematic

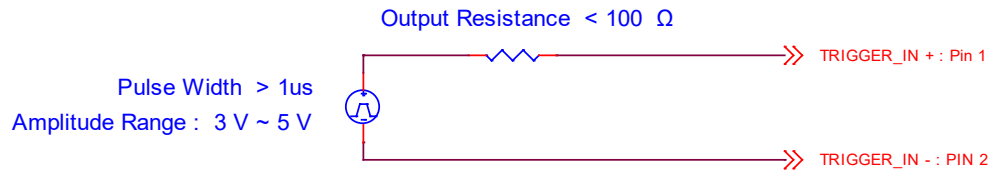

Figure 8-6 Recommended Pulse Trigger Driver Input

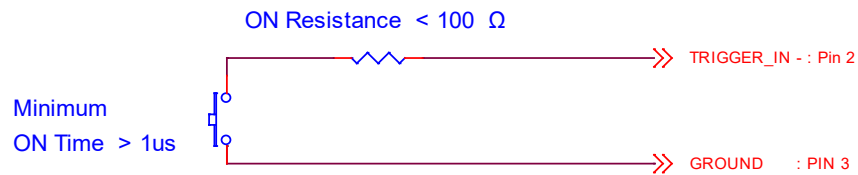

Figure 8-7 Recommended Contact Trigger Input

8.6 Strobe Output Circuit

The strobe output signal is 3.3 V output level of a TTL Driver IC. The pulse width of signal is synchronized with the exposure signal (shutter) of the camera.

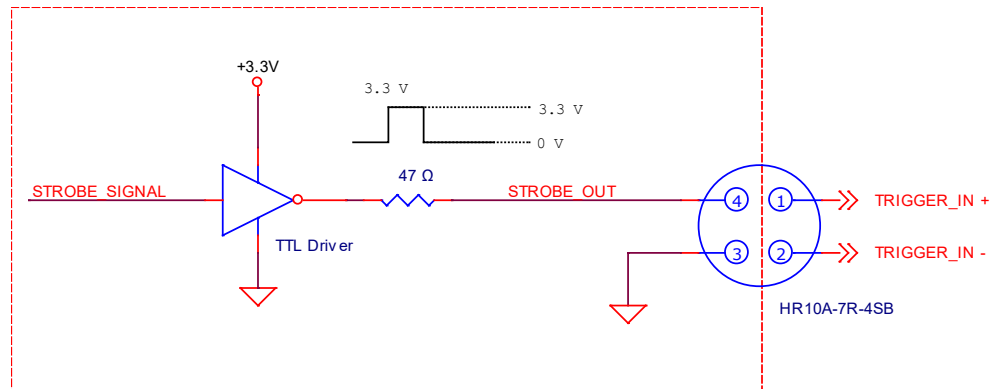

Figure 8-8 Strobe Output Schematic

9 Camera Features

9.1 Region Of Interest (ROI)

The Region of Interest (ROI) feature allows you to specify a portion of the sensor array. You can acquire only the frame data from the specified portion of the sensor array while preserving the same quality as you acquire a frame from the entire sensor array. ROI is determined as the overlapping area of two areas when designating start point and end point in horizontal and vertical direction as shown in the figure below. Start point and End point mean the starting and end of the ROI. In the VC-2MC, 4MC and 12MC models, the frame rate will increase as the vertical ROI is made smaller. However, the horizontal ROI does not affect the frame rate. In the VC-3MC and VC-25MC models, the frame rate will increase as both the vertical and horizontal ROI are made smaller.

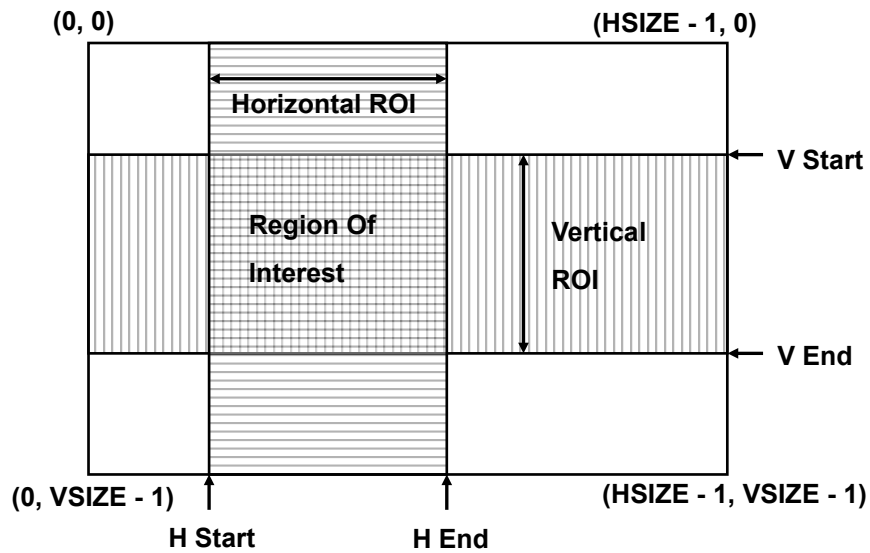

Figure 9-1 ROI

In VC-2MC, the maximum frame rates depending on the changes of vertical ROI are shown in the table below.

ROI Size (H × V)	2 Tap	4 Tap	8 Tap	10 Tap
2048 × 16	3689.3 fps	6692.2 fps	10622.3 fps	12103.0 fps
2048 × 32	2094.4 fps	4036.9 fps	6979.1 fps	7960.3 fps
2048 × 64	1123.3 fps	2250.8 fps	4139.6 fps	4725.4 fps
2048 × 128	582.8 fps	1194.1 fps	2282.4 fps	2606.7 fps
2048 × 256	297.0 fps	615.9 fps	1203.0 fps	1374.3 fps
2048 × 512	149.9 fps	312.9 fps	618.2 fps	706.4 fps
2048 × 1024	75.3 fps	157.7 fps	313.5 fps	358.2 fps

Table 9.1 VC-2MC Maximum Frame Rate depending on ROI Size

In VC-3MC, the maximum frame rates depending on the changes of both horizontal and vertical ROI are shown in the following table.

ROI Size (H × V)	8 Tap	10 Tap
640 × 480	1830 fps	2288 fps
1024 × 768	807 fps	1010 fps
1280 × 1024	486 fps	632 fps
1600 × 1200	346 fps	432 fps
1680 × 1680	229 fps	296 fps
1696 × 1710	227 fps	284 fps

Table 9.2 VC-3MC Maximum Frame Rate depending on ROI Size

In VC-4MC, the maximum frame rates depending on the changes of vertical ROI are shown in the following table.

ROI Size (H × V)	2 Tap	4 Tap	8 Tap	10 Tap
2048 × 16	3689.3 fps	6692.2 fps	10622.3 fps	12103.0 fps
2048 × 32	2094.4 fps	4036.9 fps	6979.1 fps	7960.3 fps
2048 × 64	1123.3 fps	2250.8 fps	4139.6 fps	4725.4 fps
2048 × 128	582.8 fps	1194.1 fps	2282.4 fps	2606.7 fps
2048 × 256	297.0 fps	615.9 fps	1203.0 fps	1374.3 fps
2048 × 512	149.9 fps	312.9 fps	618.2 fps	706.4 fps
2048 × 1024	75.3 fps	157.7 fps	313.5 fps	358.2 fps
2048 × 2048	39.6 fps	78.9 fps	157.1 fps	179.5 fps

Table 9.3 VC-4MC Maximum Frame Rate depending on ROI Size

In VC-12MC, the maximum frame rates depending on the changes of vertical ROI are shown in the following table.

ROI Size (H × V)	2 Tap	4 Tap	8 Tap	10 Tap
4096 × 500	78 fps	156 fps	304.1 fps	377.9 fps
4096 × 1000	39 fps	79 fps	155.8 fps	193.6 fps
4096 × 1500	26 fps	52 fps	104.7 fps	130.1 fps
4096 × 2000	19 fps	39 fps	78.9 fps	98.0 fps
4096 × 2500	15 fps	31 fps	63.2 fps	78.6 fps
4096 × 3072	13 fps	25 fps	51.6 fps	64.0 fps

Table 9.4 VC-12MC Maximum Frame Rate depending on ROI Size

In VC-25MC, the maximum frame rates depending on the changes of both horizontal and vertical AOI are shown in the following table.

ROI Size (H × V)	VC-25MC-30		VC-25MC-30 D	
	8 Tap	10 Tap	8 Tap	10 Tap
3000 × 3000	56.4 fps	69.8 fps	54.9 fps	69.2 fps
4000 × 3000	48.8 fps	60.4 fps	48.7 fps	61.3 fps
4000 × 4000	36.7 fps	45.4 fps	36.6 fps	46.1 fps
5120 × 5120	25.0 fps	30.9 fps	25.3 fps	31.9 fps

Table 9.5 VC-25MC-30 and VC-25MC-30 D Maximum Frame Rate depending on ROI Size



- The ROI values (H × V) may vary depending on the type of Camera Link frame grabber. For technical assistance, contact your local dealer or the manufacturer.
- The ROI setting commands for VC-12MC are different from the other models since it supports the Multiple ROI feature. Refer to [Table 9.4 Command List #4](#) for the related commands.

9.2 Multi-ROI (VC-12MC/VC-25MC Only)

The VC-12MC-65, VC-25MC-30 and VC-25MC-30 D cameras provide the Multi-ROI feature which allows you to define up to thirty two regions on the sensor array. When an image is acquired, only the pixel information from the defined regions will be readout of the sensor. The pixel data read out of the regions will then be combined together and will be transmitted from the camera as a single image.

9.2.1 Multi-ROI on VC-12MC

It is recommended that you first set the **Offset X** and **Width** parameters, since all of the regions must be the same width and all of the regions must be vertically aligned. The next step in the setup process is to define each individual region in order. Up to 32 regions can be set up ranging from 0 through 31. Set the each region to ON/OFF and then set the **Offset Y** (the offset between the top of the sensor and the top of the region) and **Height** (the height of the region) values to define each region. In figure 8.2, for example, three regions have been set. With these settings, the camera would output an image with 2048 (width) × 1844 (the total height of the three regions) size.

- Offset X = 1024, Width = 2048
- ROI_0
 - Offset Y = 204, Height = 512
- ROI_1
 - Offset Y = 1024, Height = 716
- ROI_2
 - Offset Y = 2356, Height = 616

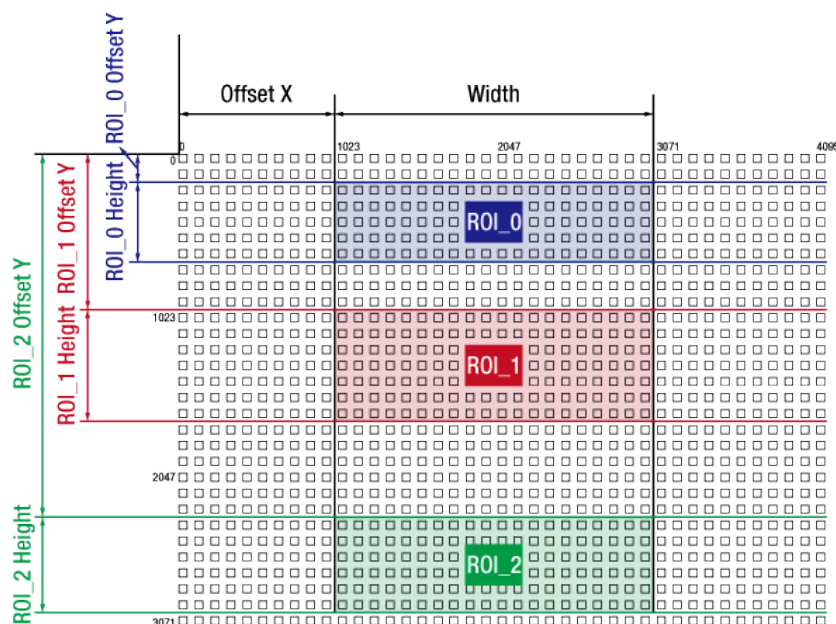

Figure 9-2 Multi-ROI (VC-12MC)

There are several things to keep in mind when setting the Multi-ROI feature on the VC-12MC camera:

- The sum of the Offset X value plus the Width value must not exceed the width (4096 on the VC-12MC) of the camera's sensor.
- The sum of the Offset Y value plus the Height value must not exceed the height (3072 on the VC-12MC) of the camera's sensor.
- The Offset X value must be a multiple of 8.
- The Width value must be a multiple of 8 ranging from 24 to 4096.
- The Offset Y and Height values must be a multiple of 4 ranging from 4 to 3072.
- You need to set the regions in order. When you set a preceding region to OFF, all the succeeding regions will be set to OFF automatically. For example, you have set four regions from 0 through 4. If you set the region 1 to OFF, the region 2, 3 and 4 will be set to OFF.
- You do not need to order the regions from top to bottom on the sensor. For example, you could place the region 1 near the bottom of the sensor, the region 2 near the top, and the region 3 in the middle.
- You can save (**Configurator > File > Save Setting > User 1** or **User 2**) the setting values for Multi-ROI to parameter storage space and then load (**Configurator > File > Load Setting > From User 1 Space** or **From User 2 Space**) the values to the camera when desired.
- Refer to [Table 9.4 Command List #4](#) for the commands related to Multi-ROI.

9.2.2 Multi-ROI on VC-25MC

It is recommended that you first set the **Width** parameter, since all of the regions must be the same width. The next step in the setup process is to define each individual region as desired. Up to 32 regions can be set up ranging from 0 through 31. Set the each region to ON/OFF and then set the **Offset X**, **Offset Y** and **Height** (the height of the region) values to define each region. In figure 8.3, for example, three regions have been set. With these settings, the camera would output an image with 1280 (width) × 4660 (the total height of the three regions) size.

- Width = 1280
- ROI_0
 - Offset X = 600, Offset Y = 0, Height = 1280
- ROI_1
 - Offset X = 1984, Offset Y = 1420, Height = 2100
- ROI_2
 - Offset X = 3264, Offset Y = 3720, Height = 1280

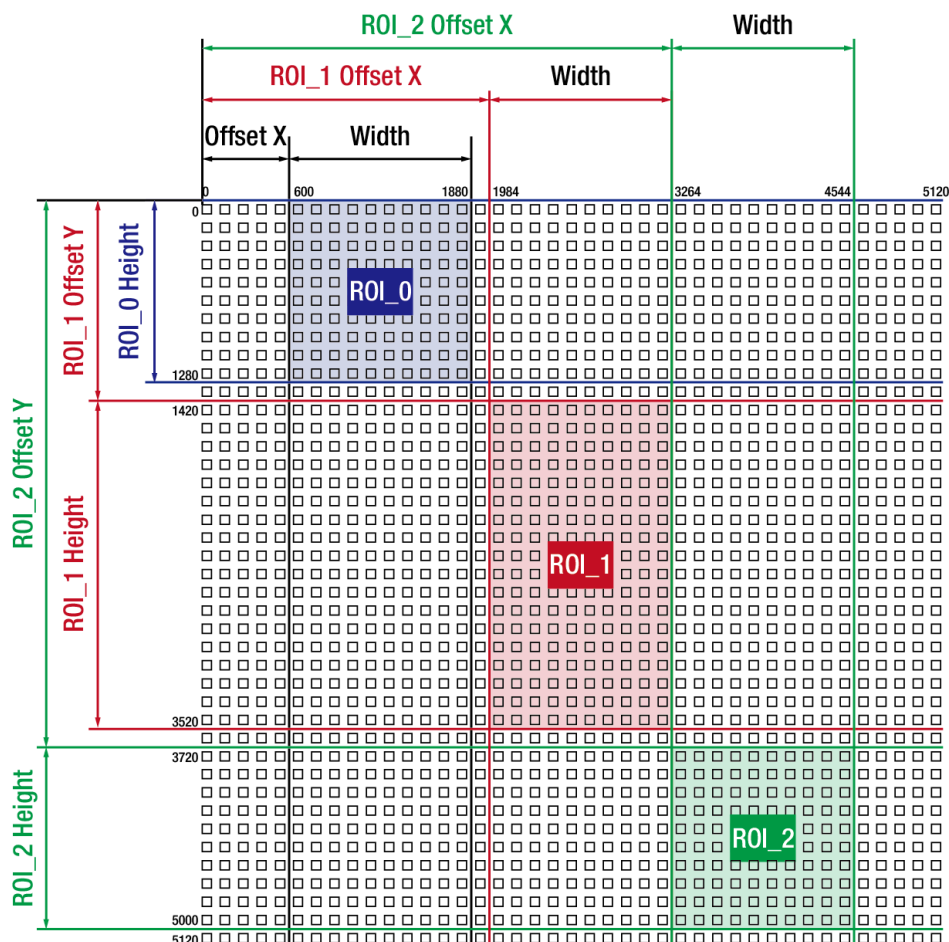

Figure 9-3 Multi-ROI (VC-25MC)

There are several things to keep in mind when setting the Multi-ROI feature on the VC-25MC-30 and VC-25MC-30 D cameras:

- The sum of the Offset X value plus the Width value must not exceed the width (5120 on the VC-25MC-30 / VC-25MC-30 D) of the camera's sensor.
- The sum of the Offset Y value plus the Height value must not exceed the height (5120 on the VC-25MC-30 / VC-25MC-30 D) of the camera's sensor.
- The Offset X value must be a multiple of 64.
- The Width value must be a multiple of 64 ranging from 256 to 5120.
- You can save (**Configurator > File > Save Setting > User 1** or **User 2**) the setting values for Multi-ROI to parameter storage space and then load (**Configurator > File > Load Setting > From User 1 Space** or **From User 2 Space**) the values to the camera when desired.
- If you make changes to the Multi-ROI settings, you must execute the 'ast' command to apply the changes.
- If you attempt to set the Multi-ROI settings with invalid values, the camera will not acquire images.
- Refer to [Table 9.4 Command List #4](#) for the commands related to Multi-ROI.

9.3 Binning (VC-25MC Monochrome Only)

Binning has the effects of increasing the level value and decreasing resolution by adding the values of the adjacent pixels and sending them as one pixel. VC-25MC provides two binning factor ($\times 1$ and $\times 2$) that the user can apply both horizontally and vertically. The below figure shows application of 2×2 binning, four pixels are summed and reported out of the camera as a single pixel. Using binning reduces the resolution of camera's imaging sensor in half, however, it results in double signal to noise ratio with the same brightness as an original image. You can set the Binning Factor by using the 'sbf' command.

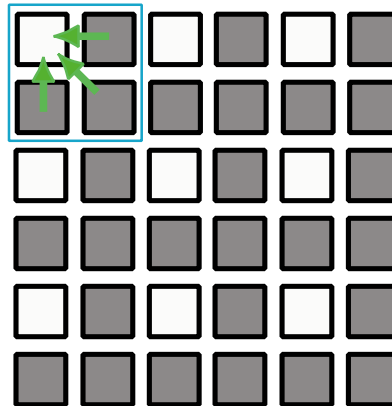

Figure 9-4 2×2 Binning

9.4 Exposure

The CMOS sensor of VC series uses global shutter that exposes the entire imager simultaneously. The below figure illustrates the timing of exposure and readout of CMOS sensor. Readout is performed consecutively from first to last line where readout defines the process of reading the accumulated charges on pixels. Readout Time (also called Transfer Time) defines the rate at which one frame of an image is transferred.

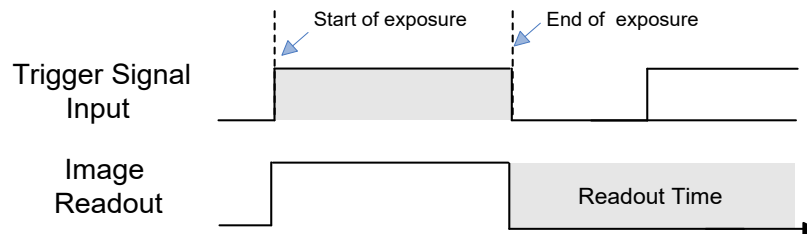

Figure 9-5 Exposure Timing Diagram

9.4.1 Real Exposure (VC-12MC Only)

In VC-12MC-65, when you set the Trigger Mode to Free-Run or the Exposure Mode to Program, the exposure time will be determined by the user settings ('set' command). With these settings, the camera will generate trigger signals internally. As soon as the camera detects a trigger signal, the camera will begin a frame exposure. When the exposure time ends, the pixels are being sampled and prepared for readout. This sequence is called the frame overhead time (FOT). Immediately after the FOT, the frame is read out automatically. During the FOT, an additional exposure time will be applied as the offset value shown in the Figure 8.5. This offset value varies depending on the camera's Camera Link Output Mode settings. The setting value on the exposure time is equal to actual exposure time, because the offset value is compensated on the actual exposure time. In 8 tap output channel mode, for example, the exposure time is set to 200 μs . The camera will subtract offset value 50 μs from the exposure time setting internally, and thus the actual exposure time will be 200 μs as the user settings. Due to the offset value, the minimum exposure time is limited as shown in the Table 8.6.

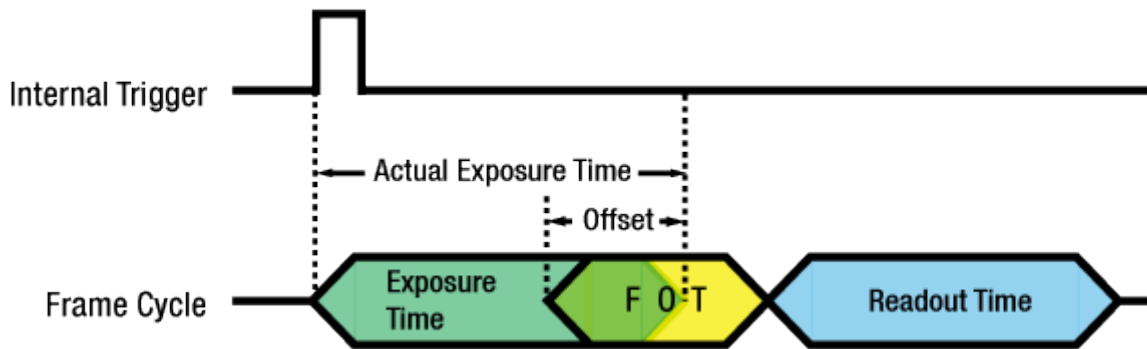

Figure 9-6 Real Exposure for VC-12MC-65

Camera Link Output Mode	Offset Value
2 Tap	50 μs
4 Tap	50 μs
8 Tap	50 μs
10 Tap	40 μs

Table 9.6 Offset Value for VC-12MC-65

Camera Link Output Mode	Minimum Exposure Time
2 Tap	50 μs
4 Tap	50 μs
8 Tap	50 μs
10 Tap	40 μs

Table 9.7 Minimum Exposure Time for VC-12MC-65

9.5 Trigger Mode

Trigger mode of the camera is divided into Free-Run mode where image is synchronized to Internal Trigger signal created inside the camera and External Sync mode where image is synchronized to the trigger signal entered into the external port.

9.5.1 Free-Run Mode

In Free-Run mode, the period of internal trigger signal is determined by Transfer Time (1 Frame data transmission time) and Exposure setting value, and image is obtained with this periodic signal. Frame Rate, the period of internal signal, is determined with the following two conditions.

- Case 1: Exposure Time < Frame Transfer Time
 - $\text{Frame Rate(FPS)} = 1 / \text{Frame Transfer Time (sec)}$ → has a fixed value.
- Case 2: Exposure Time > Frame Transfer Time
 - $\text{Frame Rate(FPS)} = 1 / \text{Exposure Time (sec)}$ → varies depending on Exposure Time value.

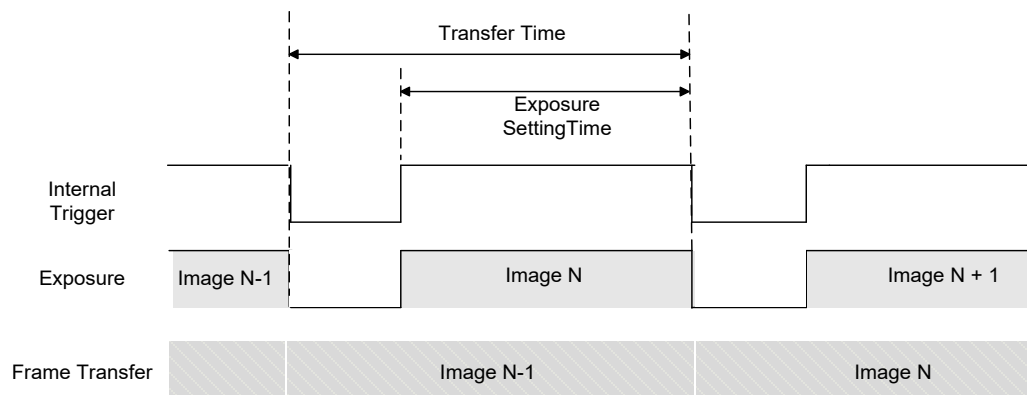

Figure 9-7 Exposure Time is shorter than Readout Time

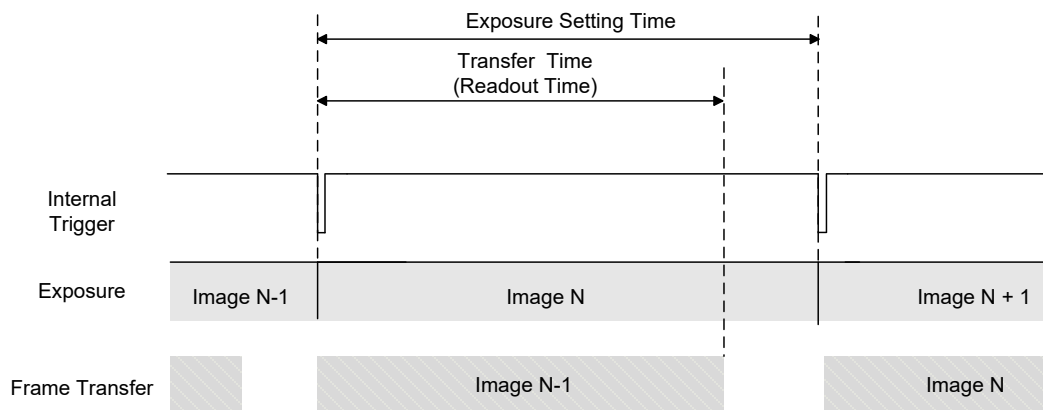

Figure 9-8 Exposure Time is longer than Readout Time

9.5.2 External Sync Mode

In External Sync Mode, camera keeps standby status until trigger signal is entered, and when trigger is entered, the image is transmitted (frame transfer) after exposure process. To operate the camera in External Sync mode, it is required to set Trigger Source regarding which input, CC1 input port or External Trigger port, will be used for trigger signal, as well as Polarity and Exposure source of the signal entered.

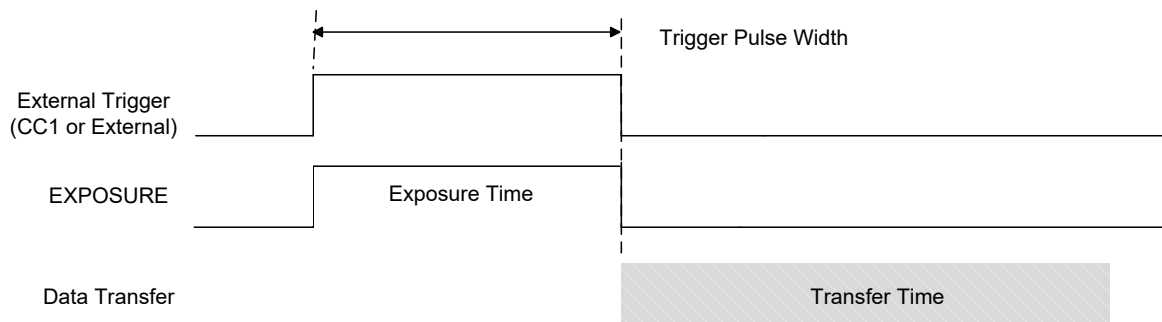

Figure 9-9 External Sync Mode

Following is the summary of basic setting items.

- **Trigger Source:** select either CC1 (Camera Control Port 1) or External Connector as source of the external trigger input signal.
- **Trigger Polarity:** set whether polarity of Trigger signal entered is Active High or Active Low.
- **Exposure Source:** select to synchronize exposure time with pulse width of trigger input signal or with exposure time programmed inside the camera.

9.5.3 Overlap Trigger Input

When trigger is entered during frame transfer as shown in the figure below, it performs exposure process for newly entered trigger while transferring the previous data. In this case, shooting images is possible up to the maximum frame rate (speed of $1/\text{Transfer Time (sec)}$) regardless of the exposure time.

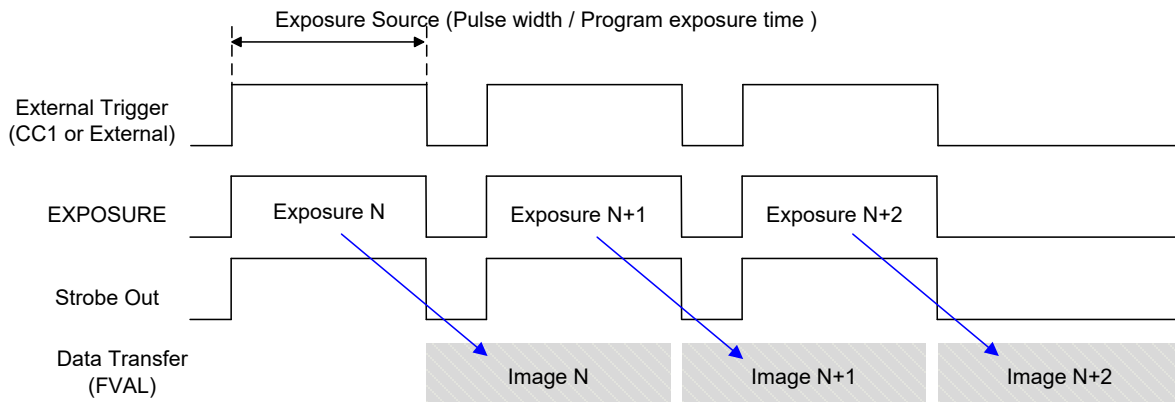

Figure 9-10 Camera Operation when Overlap Trigger is entered

Following list shows the operation of camera on exceptional trigger input.

- When the trigger signal with the faster period than the maximum frame rate condition is entered, the next frame transfer is performed before completing the previous frame transfer. This causes the failure of obtaining overall image.
- If new trigger is entered during the exposure process after Exposure Source is set as Program, the newly entered signal will be ignored. In this case, exposure time is longer than trigger input period and the frame rate will be slower than trigger input period since all the entered trigger signals cannot synchronize.

9.6 Camera Link Output

VC Series supports 2 Tap, 4 Tap, 8 Tap or 10 Tap output modes[†] according to the user interface. Tap setting value defines the number of output pixel data for each Pixel Clock Cycle (85 MHz), and the speed of frame data transmission varies depending on the tap setting. Frame Data is output in interleaved order as shown in the figure below. This tap setting can be set using the 'scl' command.

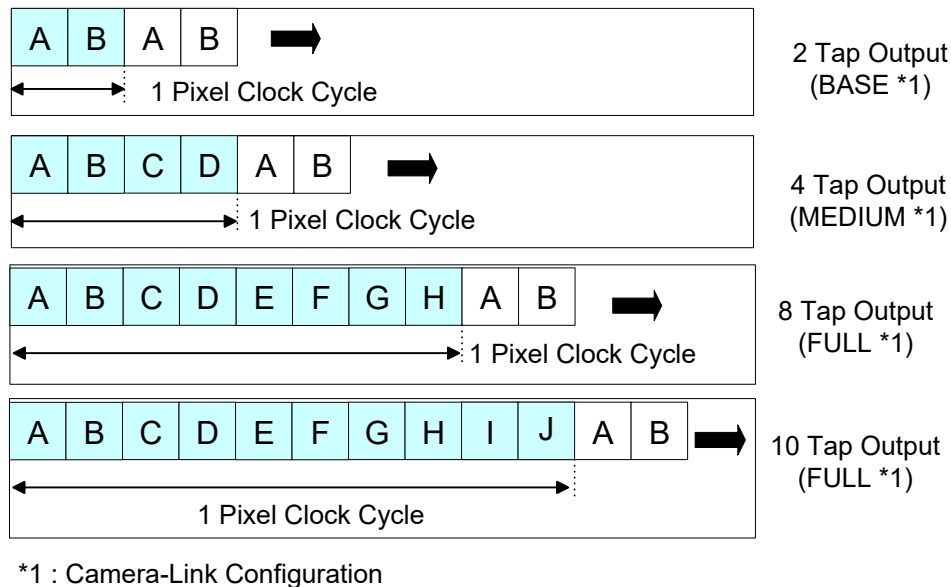

Figure 9-11 Camera Link Output Mode



† Supported Camera Link Output Mode

- VC-2MC-150 and VC-4MC-80 support 2 Tap and 4 Tap.
- VC-2MC-340, VC-4MC-180 and VC-12MC-65 support 2 Tap, 4 Tap, 8 Tap and 10 Tap.
- VC-3MC-280, VC-25MC-30 and VC-25MC-30 D support 8 Tap and 10 Tap.

9.7 Gain and Offset

Gain and Offset can be changed through Voltage Reference adjustment which is applied commonly to all ADCs. Gain adjustment can be set among 0 ~ 12 dB and setting value can be set as a value from 0 to 64 step. Relation between setting value and actual Gain (dB) is shown below:

$$\text{Gain(dB)} = (\text{setting value}) \times 0.19 \text{ dB}$$

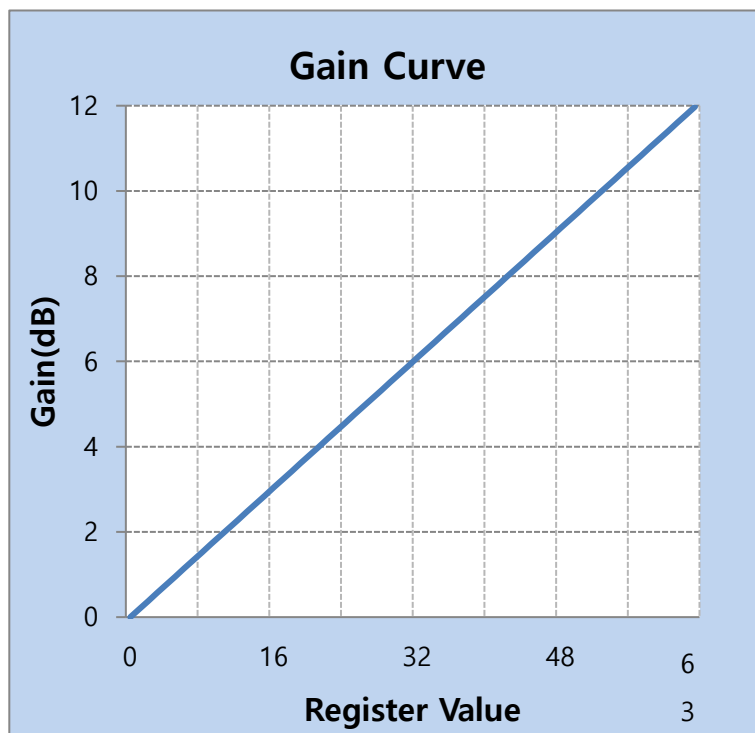

Figure 9-12 Register Setting vs Gain

Offset can be set between 0 ~ 63 (LSB) based on 10 bit data output and setting value has 64 step values.

9.8 Defective Pixel Correction

The CMOS sensor may have Defect Pixels which cannot properly react to the light. Correction is required since it may deteriorate the quality of output image. Defect Pixel information of CMOS used for each camera is entered into the camera during the manufacturing process. If you want to add Defect Pixel information, it is required to enter coordinate of new Defect Pixel into the camera.

For more information, refer to [Appendix A](#). The 'sdc' command is used to set whether to use Defective Pixel Correction feature.

9.8.1 Correction Method

Correction value for Defect Pixel is calculated based on valid pixel value adjacent in the same line.

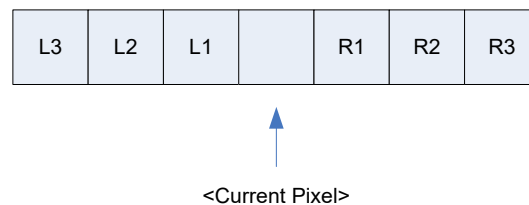

Figure 9-13 Location of Defect Pixel to be corrected

If Current Pixel is a Defect Pixel as shown in the above figure, correction value of this pixel is obtained as shown in the following table depending on whether surrounding pixel is Defect Pixel or not.

Adjacent Defect Pixel(s)	Correction value of Current Pixel
None	$(L1 + R1) / 2$
L1	R1
R1	L1
L1, R1	$(L2 + R2) / 2$
L1, R1, R2	L2
L2, L1, R1	R2
L2, L1, R1, R2	$(L3 + R3) / 2$
L2, L1, R1, R2, R3	L3
L3, L2, L1, R1, R2	R3

Table 9.8 Calculation of Defect Pixel Correction Value

9.9 Flat Field Correction (VC-2MC-340/VC-4MC-180/VC-12MC/VC-25MC Only)

The Flat Field Correction feature improves the image uniformity when you acquire a non-uniformity image due to external conditions. The Flat Field Correction feature can be summarized by the following equation:

$$IC = IR / IF$$

IC: Level value of corrected image;

IR: Level value of original image;

IF: Level value of Flat Field data.

9.9.1 Sequence of Flat Field Correction

Under actual conditions, generate Flat Field Correction data and save the Flat Field Correction data into the camera's non-volatile memory according to the following procedures.

How to generate Flat Field Correction data using Configurator

1. Select the **FFC** tab and then click the **Generate** button in the **FFC Data** category to execute the Flat Field Generator.
2. Acquire one image by operating the camera in the Free-Run mode or by applying an exposure start trigger signal to the camera.
3. In the **View** tab, click the **Flat Field Corr.** check box in the **Image Processing** category to enable the FFC.
4. In the **FFC** tab, click the **Save to Flash** button in the **Flash Memory** category to save the generated Flat Field Correction data into the non-volatile memory. The scaled down Flat Field data will be expanded and then applied as shown in the Figure 8.16 when they are used for correction.

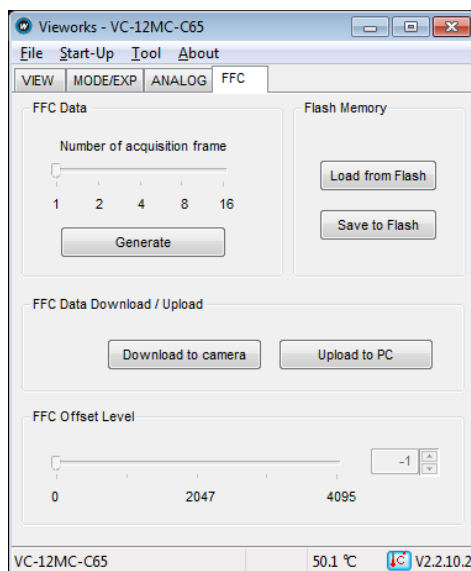

Figure 9-14 Flat Field Correction in Configurator

How to generate Flat Field Correction data using Serial Commands

1. Use the 'gfd' command to execute the Flat Field Generator.
2. Acquire one image by operating the camera in the Free-Run mode or by applying an exposure start trigger signal to the camera.
3. Use the 'sfc' command to enable the generated Flat Field Correction data.
4. Execute the 'sfd' command to save the generated Flat Field Correction data into the non-volatile memory. The scaled down Flat Field data will be expanded and then applied as shown in the Figure 8.16 when they are used for correction.



- It is recommended that you enable the Defective Pixel correction feature before executing the Flat Field Generator.
- Before executing the Flat Field Generator, you must set the camera as follows:
 - OffsetX, Y: 0
 - Width, Height: Maximum values
 - Binning: 1×

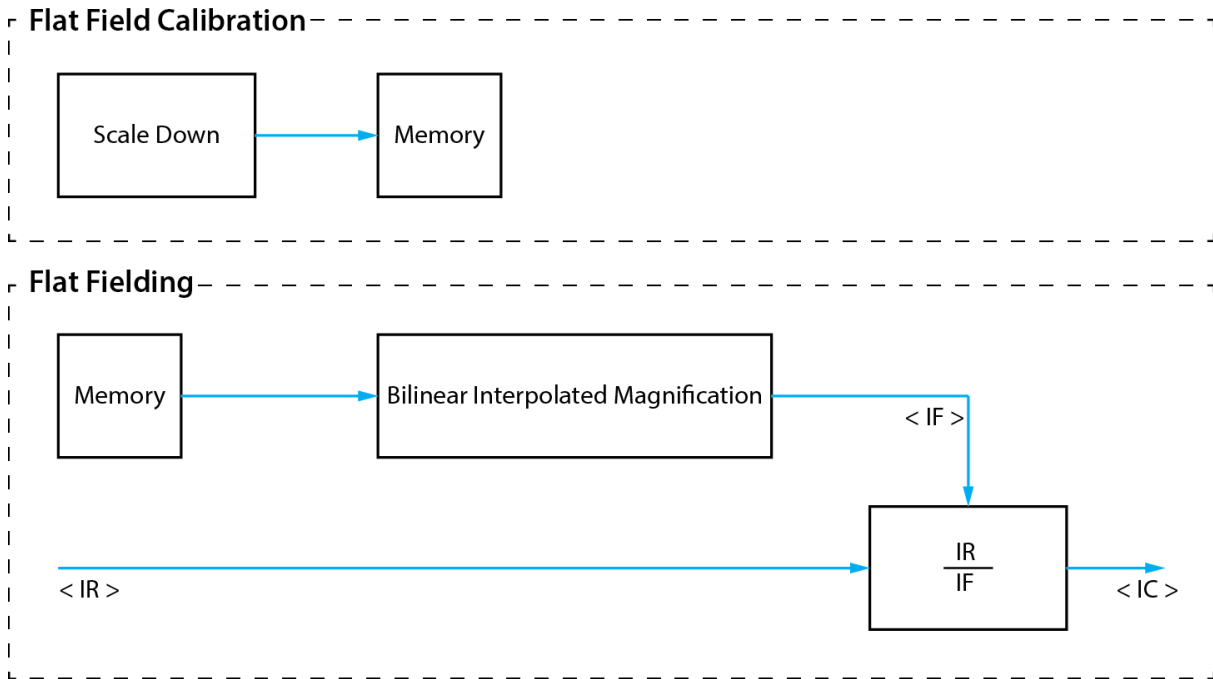

Figure 9-15 Generation and Application of Flat Field Data

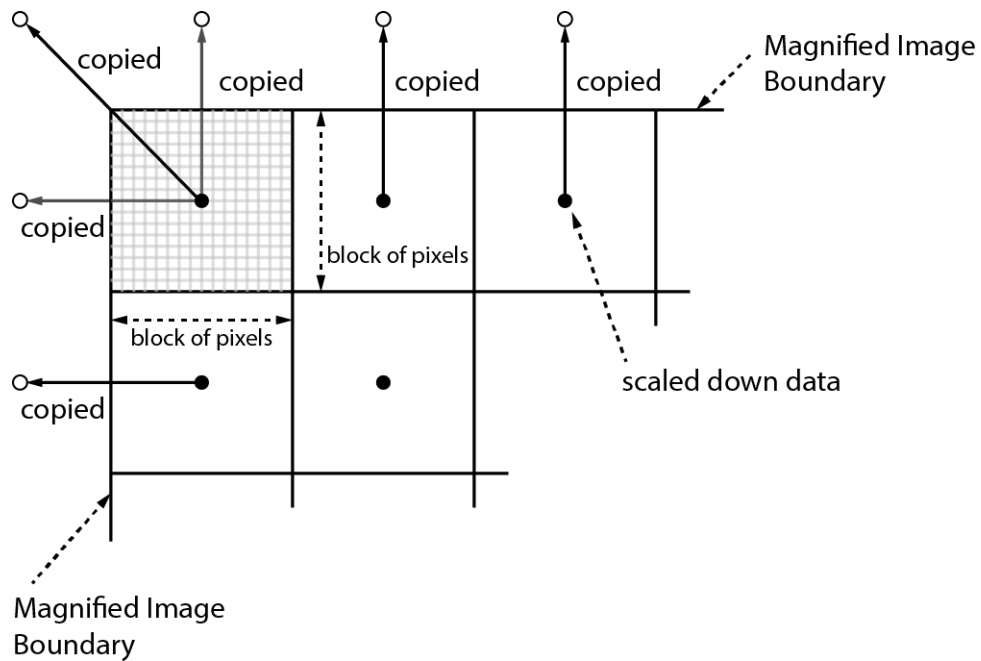

Figure 9-16 Bilinear Interpolated Magnification

9.9.2 Flat Field Selector (VC-12MC/VC-25MC Only)

As mentioned above, the active Flat Field data is stored in the camera's volatile memory and the data is lost if the camera is reset or powered off. To use the active or generated Flat Field data after the camera is powered on or reset, you need to save them in the camera's non-volatile memory. The VC-12MC-65 and VC-25MC-30 cameras provide four reserved areas, and the VC-25MC-30 D camera provides ten reserved areas in the camera's non-volatile memory available for saving Flat Field data. You can use the **Flat Field Selector** feature to select one of the reserved areas.

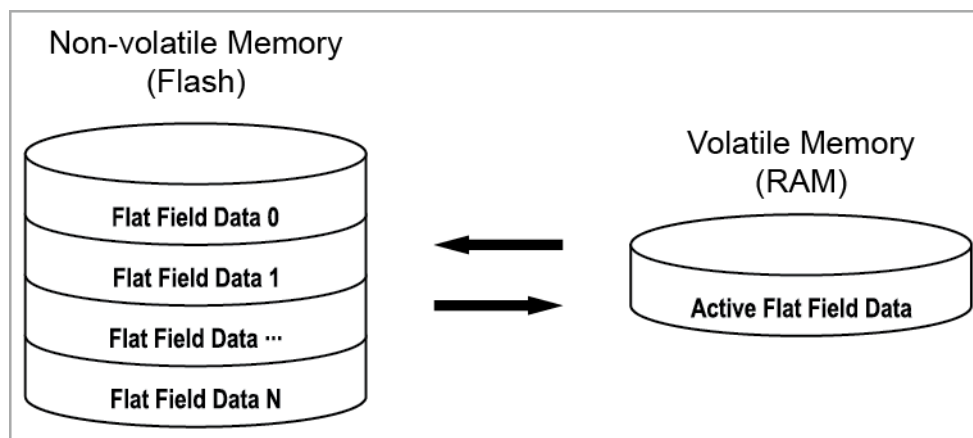

Figure 9-17 Flat Field Selector

Saving a Flat Field data

To save the current active Flat Field data into a reserved area in the camera's flash memory,

1. Use the 'sfs 0/1/2/.../n' command to specify a reserved area where the current active Flat Field data will be stored.
2. Use the 'sfd' command or click the **Save to Flash** button in Configurator to save the active Flat Field data to the selected reserved area.

Loading the Flat Field data

If you saved a Flat Field data into the camera's non-volatile memory, you can load the saved Flat Field data from the camera's non-volatile memory into the camera's active Flat Field data.

1. Use the 'sfs 0/1/2/.../n' command to specify a reserved area whose Flat Field data will be loaded into the camera's active Flat Field data.
2. Use the 'lfd' command or click the **Load from Flash** button to load the selected Flat Field data into the active Flat Field data.

9.10 High Dynamic Range (VC-2MC-M340/VC-4MC-180 Only)

When you acquire images in some situations where a bright light source or shiny materials are located within the field of view, the light areas appear overexposed in the acquired images. And if you use a short exposure time to avoid overexposure in the light areas of the acquired images, all details will be lost in the darker areas.

The Multiple Slop capability is implemented on the VC-2MC-M340 and VC-4MC-M180 cameras to acquire high dynamic range (HDR) images which have higher variations between the brightest and darkest portions of the images. As shown in the figure below, when the bright pixel reaches a certain output level, it will be maintained at the level for a programmable time from overall exposure time. This happens two times to make sure that the pixel is not saturated at the end of exposure time.

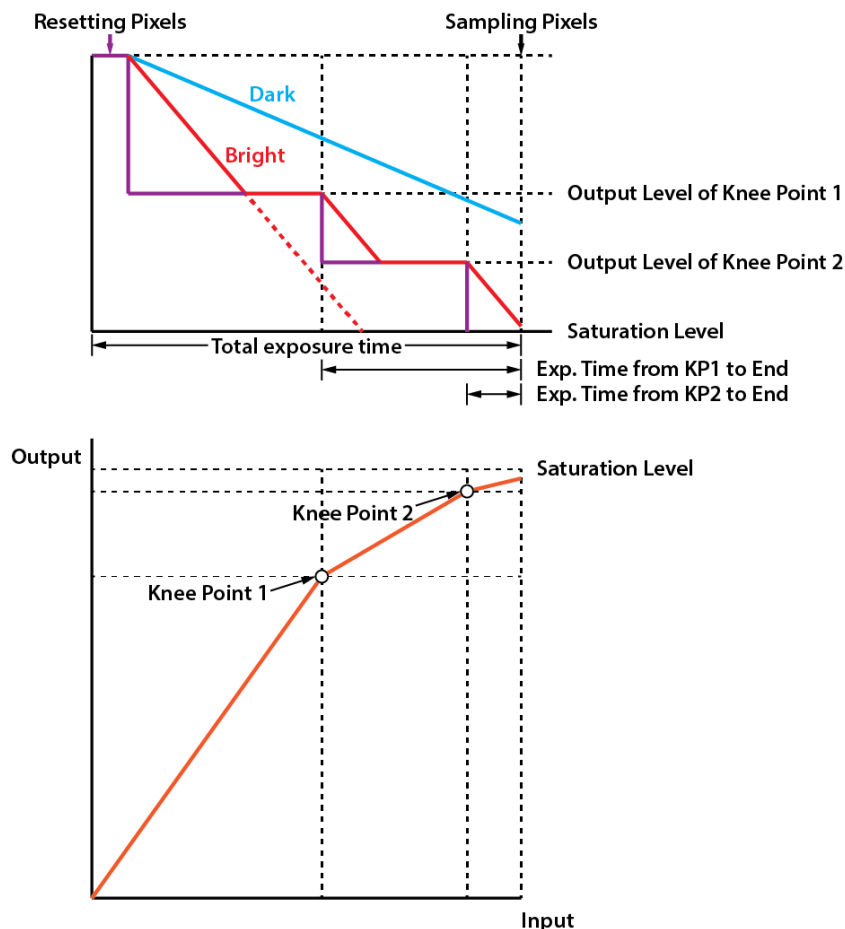

Figure 9-18 High Dynamic Range Concept Drawing

To use the High Dynamic Range feature, you must set the Trigger Mode to Free-Run or set it to Program in the External Sync item. Use the 'shm' command to activate the HDR feature and use 'shd n' command to set the dynamic range in dB. The available setting range is 0 to 40 dB.

9.11 Sequencer for Multi-FFC (VC-25MC-30 D Only)

The Sequencer feature provided by the VC-25MC-30 D camera allows you to apply different sets of parameter settings, called 'Sequencer Set', to a sequence of image acquisitions. As the camera acquires images, it applies one Sequencer Set after the other. This allows the camera to respond quickly to changing imaging requirements. Each Sequencer Set is identified by an index number ranging from 0 to 29. Accordingly, you can define up to 30 different Sequencer Sets. On the VC-25MC-30 D camera, only the Flat Field correction data can be configured for Sequencer Sets. The commands related to Sequencer are as follows.

Command		Value	Description
Sequencer Mode	sssm	0	Sequencer Off
		1	Enables the Sequencer.
Sequencer Set Count	sssc	1 ~ 30	Sets the number of Sequencer Sets to be applied.
Sequencer Set Selector	ssss	n, m	n: Selects an index number of Sequencer Set to be configured (0 ~ 29). m: Selects an index number of Flat Field data to be configured (0 ~ 9).
Reset Sequencer	rssc	-	Returns to Sequencer Set 0.
Reset Flat Field Data	rfd	-	Clears the Flat Field data that is currently selected with the Flat Field Selector ('sfs n').

Table 9.9 Commands related to Sequencer



To apply Sequencer Sets, you must first enable the Flat Field Correction feature ('sfc 1').

Use Case - Applying Four Different Flat Field Correction Data to Sequencer Sets

For example, assume that four different Flat Field Correction data optimized for White, Green, Red and Blue pixels are applied to four different Sequencer Sets to inspect LCD panels.

1. Disables the Sequencer Mode ('sssm 0').
2. Set the Sequencer Set Count command to 4 ('sssc 4').
3. Select the first Sequencer and the Flat Field data to be configured for the Sequencer by using the Sequencer Set Selector command ('ssss 0 0'). Then, select the second, third and fourth Sequencers and the Flat Field data respectively ('ssss 1 1', 'ssss 2 2', 'ssss 3 3').
4. Enables the Sequencer Mode ('sssm 1').

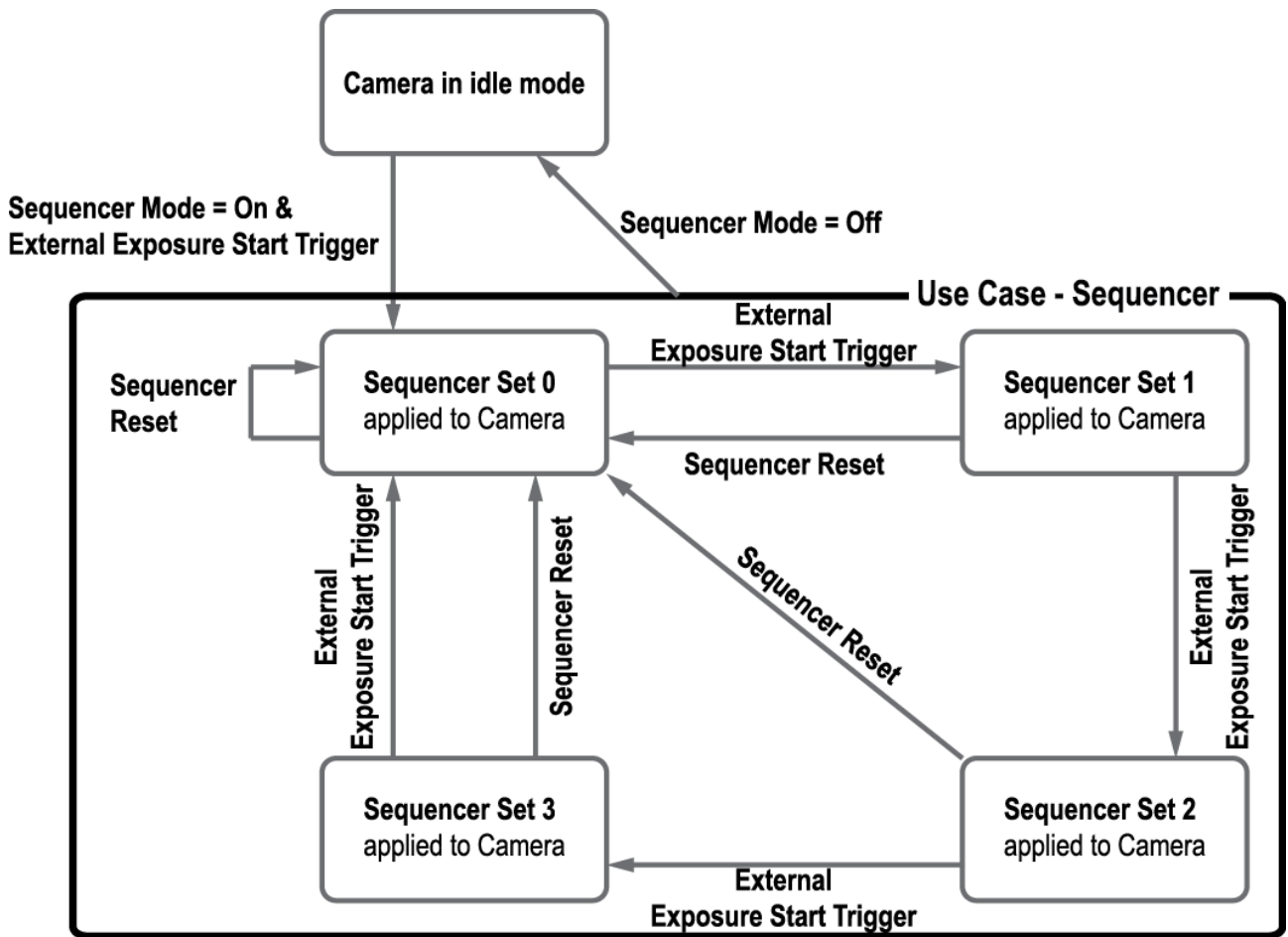

Figure 9-19 Sequencer Diagram (Use Case)

9.12 Auto White Balance (VC-12MC/VC-25MC Only)

The Auto White Balance feature is implemented on the VC-12MC-C65, VC-25MC-C30 and VC-25MC-C30 D color cameras. It will control the white balance of the image acquired from the color camera according to the GreyWorld algorithm. The entire pixel data will be used by the Auto White Balance feature to control the white balance. As soon as you activate the Auto White Balance feature, the Digital Red, Digital Green and Digital Blue will be set to 1. Then the Digital Red and Digital Blue will be adjusted to control the white balance. The 'arg' command is used to set whether to use the Auto White Balance feature.

9.13 Temperature Monitor

The camera has an embedded sensor chip to monitor the internal temperature. The 'gct' command is used to check the temperature of the camera.

9.14 Status LED

There is a green LED to inform the operation status on the back of camera. LED status and corresponding camera status are as follows:

- Continuous ON: operates in Free-Run Mode.
- Repeat ON for 0.5 second, OFF for 0.5 second: operates in Trigger Mode.
- Repeat ON for 1 second, OFF for 1 second: outputs Test Image.
- Repeat ON for 0.25 second, OFF for 0.25 second: operates in Trigger Mode and outputs Test Image.

9.15 Data Format

The camera processes image data in the unit of 10 bit. You can determine the data format (8 bit or 10 bit[†]) of image data transmitted from the camera by using the 'sdb 8 / 10' command. When the camera is set for 8 bit data format, the 2 least significant bits will be dropped from overall 10 bits.

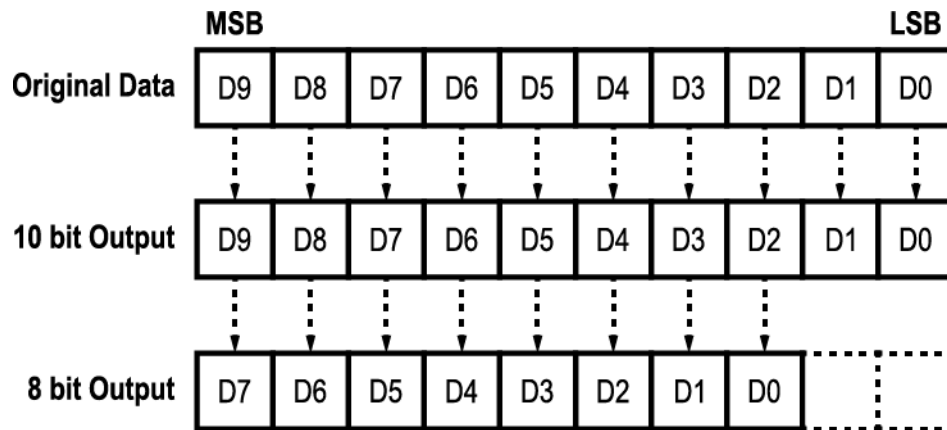

Figure 9-20 Data Format



† Supported data format

The VC-3MC-280 camera supports only the 8 bit data format.

9.16 Test Image

To check normal operation of the camera, it can be set to output test image created inside, instead of image data from the imaging sensor. There are 3 types of test image; image with different value in horizontal direction (Test Image 1), image with different value in diagonal direction (Test Image 2), and moving image with different value in diagonal direction (Test Image 3). Test image can be applied in all operation modes of the camera. To set Test Image, use the 'sti' command.

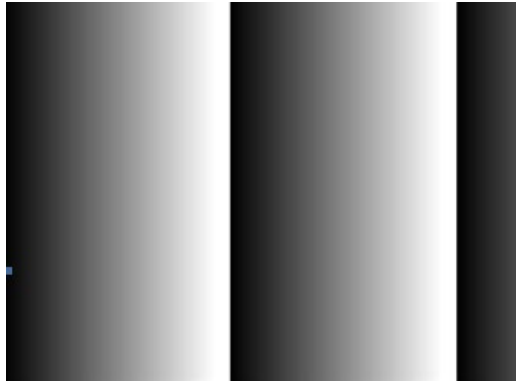

Figure 9-21 Test Image 1

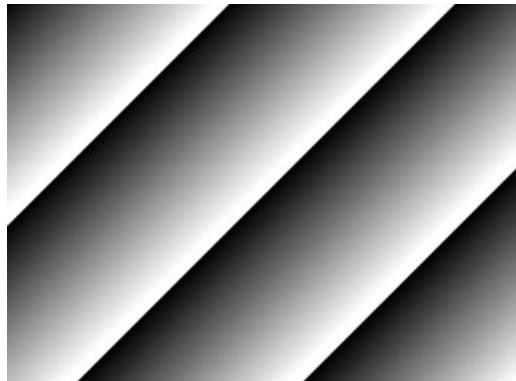

Figure 9-22 Test Image 2

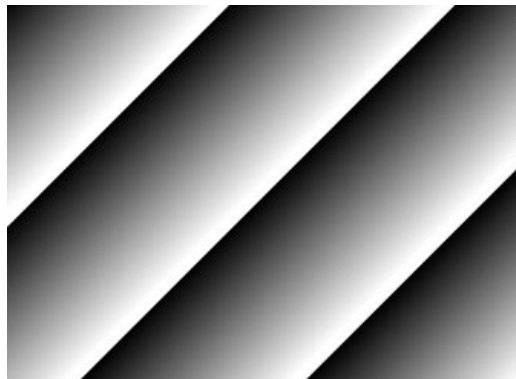

Figure 9-23 Test Image 3

9.17 Strobe

The camera can provide a Strobe output signal. The signal goes high when the exposure time for each frame acquisition begins and goes low when the exposure time ends as shown in the figure below. This signal can be used as a flash trigger and is also useful when you are operating a system where either the camera or the object being imaged is movable. Typically, you do not want the camera to move during exposure. You can monitor the Strobe output signal to know when exposure is taking place and thus know when to avoid moving the camera.

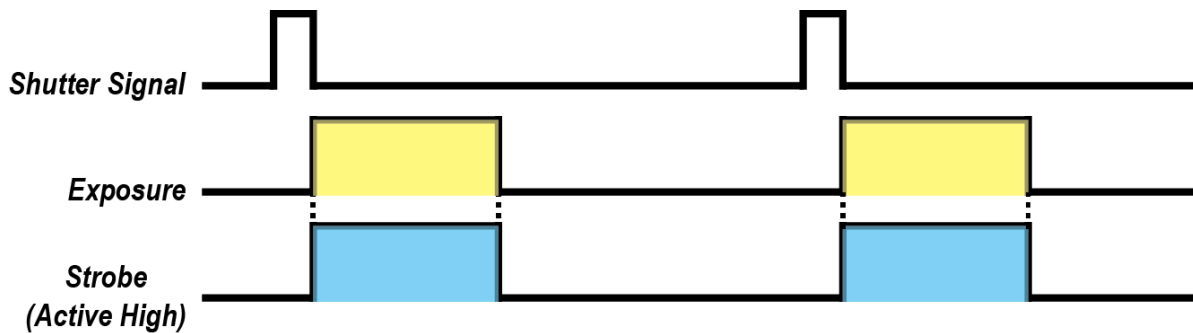

Figure 9-24 Strobe Output

9.17.1 Strobe Offset (VC-25MC Only)

The Strobe Offset value specifies a delay that will be applied between the point where the shutter signal rises and the point where the Strobe output signal rises. You can set the Strobe Offset in microseconds by using the 'sso' command. The width of Strobe output signal will be the same as the width of exposure but the only the point where the Strobe output signal rises is adjusted.

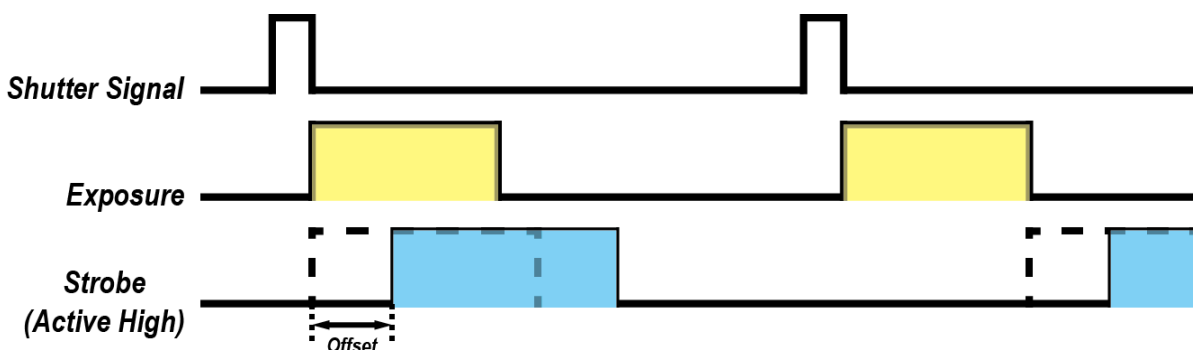

Figure 9-25 Strobe Offset

9.17.2 Strobe Polarity

The Strobe Polarity is used to select Active High or Active Low triggering. You can set the polarity of the strobe output signal by using the 'ssp' command.

9.18 Field Upgrade

The camera has the function to upgrade firmware and FPGA logic through RS-644 interface of Camera Link, rather than disassemble the camera in the field. See [Appendix B](#) for details on how to upgrade.

9.19 Dark Image Correction

CMOS sensor may result in lower sensitivity at dark level. This is caused by fixed pattern noise variation depending on the exposure settings or characteristic change according to the temperature variation of AFE and sensor cell. Sensitivity change resulted by temperature variation is less than 1 dB/10 degree. The acquisition condition of correction data is 25 degree based on the camera case temperature. To acquire optimized image at user environment, it is recommended to perform dark image correction after the camera is installed and the temperature of the camera is stabilized.



VC-25MC-30 and VC-25MC-30 D do not support dark image correction.

9.19.1 Sequence of Dark Image Correction

How to Correct Dark Image using Configurator

1. Prevent penetration of light into the camera image sensor.
2. Click the **Generate Data** button in the **View** tab to generate correction data.
3. Click the **Save Data** button to save correction data in the flash memory. The saved data will be applied to the camera automatically when the camera is turned on.

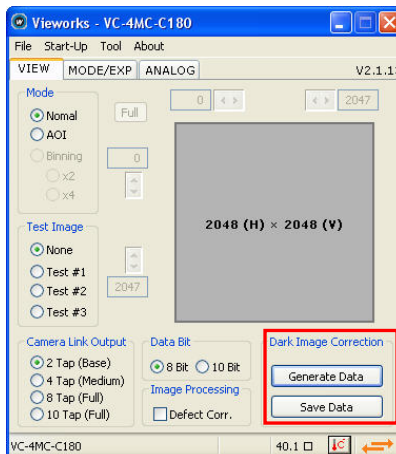

Figure 9-26 Dark Image Correction on Configurator

How to Correct Dark Image using Serial Command

1. Prevent penetration of light into the camera image sensor.
2. Use the terminal command 'god' to generate correction data in the camera.
3. Use the terminal command 'sod' to save correction data in flash memory.

9.20 White Pixel

If you use a VC-25MC-30 or VC-25MC-30 D camera under the condition of high ambient temperature, white pixels (also known as hot pixels) may be occurred due to the characteristic of equipped high resolution CMOS sensor.

White pixels are caused by accumulated current leakage in the charge storage region inside the imaging sensor's active pixel. If temperature is increased by seven degrees, it is getting worse with double white pixels. To effectively reduce white pixels, maintain the operating temperature as low as possible and mount the camera on a substantial metal component in your system to provide sufficient heat dissipation. You can also use the defective pixel correction to remove white pixels. Add a defective pixel to defective pixel map or modify the defective pixel map stored in the camera.

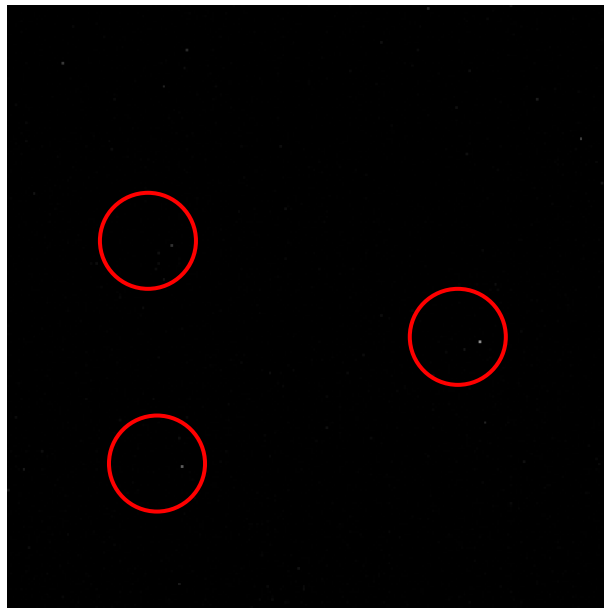

Figure 9-27 White Pixel

10 Camera Configuration

10.1 Setup Command

All the settings for the camera are carried out through RS-644 serial interface of camera link. With the following communication setting, it can be controlled using terminal or direct control at user application.

- Baud Rate: 19200 bps
- Data Bit: 8 bit
- Parity Bit: No Parity
- Stop bit: 1 stop bit
- Flow control: None

All types of camera setting commands except Firmware Download, requiring massive data transmission are delivered in ASCII command type. All camera setup commands start from user application and the camera returns the response ('OK', 'Error' or information) for the command. The camera informs the completion of command execution through response with write command, while the camera returns the error response or information with read command.

```

Command format:
<command> <parameter1> <parameter2> <cr>
0~2 parameters follow the command.
Response:
- If execution of write command is successfully completed
  OK <cr> <lf>

```

ex) Write command

```

In response to a "set 100" command the camera will return (in hex value)
Command   : 73 65 74 20 31 30 30 0D
           set 100<cr>
Response  : 73 65 74 20 31 30 30 0D 0A 4F 4B 0D 0A 3E
           Set 100<cr><lf>          OK<cr><lf>  >
           Echo                    result      prompt

```

```
If execution of read command is successfully completed  
<parameter1> <cr> <lf>
```

ex) Read command

```
In response to a "get" command the camera will return (in hex value)  
Command   : 67 65 74 0D  
           get <cr>  
Response  : 67 65 74 0D 0A 31 30 30 0D 0A 3E  
           get<cr><lf>    100<cr><lf>    >  
           Echo          response      prompt
```

```
If execution of command is not completed  
Error : <Error Code> <cr> <lf>
```

```
Prompt:  
After sending response, Camera sends prompt always. '>' is used as prompt.  
Types of Error Code  
0x80000481 : values of parameter not valid  
0x80000482 : number of parameter is not matched  
0x80000484 : command that does not exist  
0x80000486 : no execution right
```

10.2 Actual Time Applied for Commands

When you execute a command, the actual or real time applied for the command varies depending on the type of the command and operating status of the camera.

All commands except Set Exposure Time ('set') command are applied to change the settings as illustrated below, on the rising edge of a REQ_Frame signal before starting readout process.

When you execute a 'set' command, the exposure time setting will be changed at the starting of the exposure.

In the Trigger mode, you must execute commands before applying trigger signals in order to synchronize image outputs with the commands.

In the Free-Run mode, even if you execute a command, you may acquire up to two images without applying the command. This is true because it is hard to verify the current operating status of the camera in the Free-Run mode.

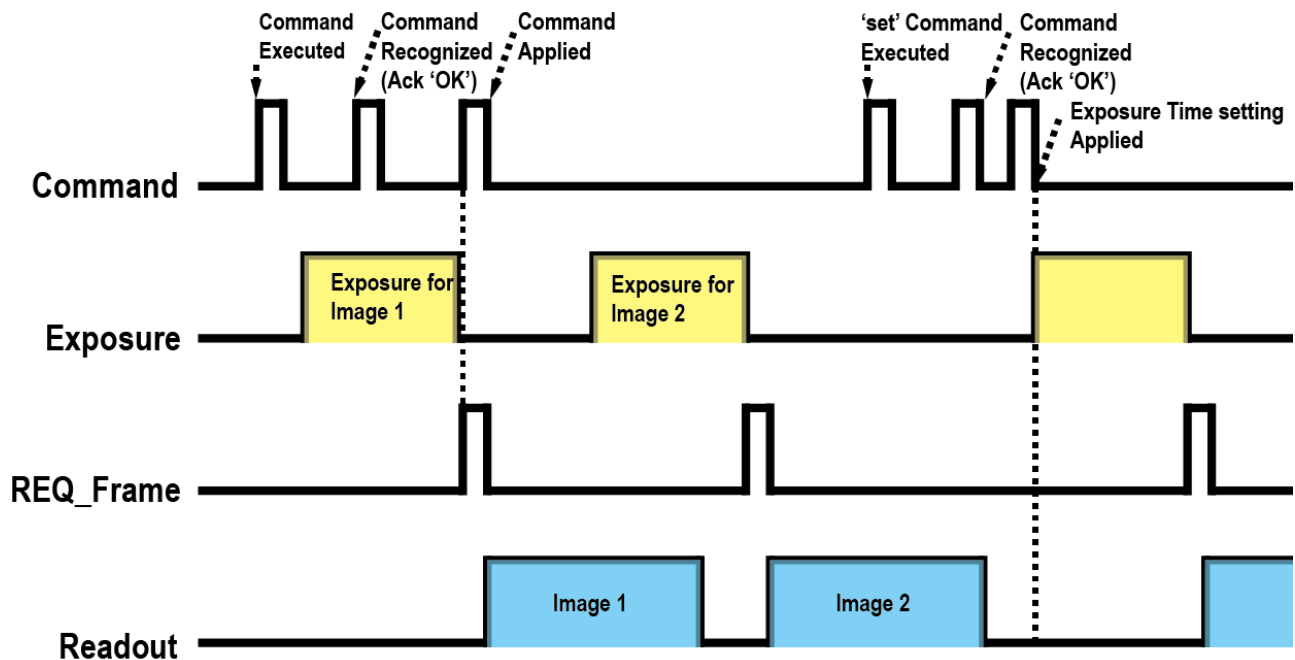

Figure 10-1 Actual Time Applied for Commands

10.3 Parameter Storage Space

The camera has 3 non-volatile storage space used for parameter storage and 1 volatile work space that is applied to actual camera operation. 3 storage space is divided into Factory Space that contain basic value at the factory, and 2 user space (User Space 1, User Space 2) that can save parameter value temporarily set by the user. User space can be read and written, but Factory space can be read only.

At camera booting, setting value in one of 3 storage spaces is copied to work space according to Config Initialization value and value of the space is used for camera setting. Since values in work space is valid only while the power is on, it should be copied to user space 1 or user space 2 using the 'sct' command.

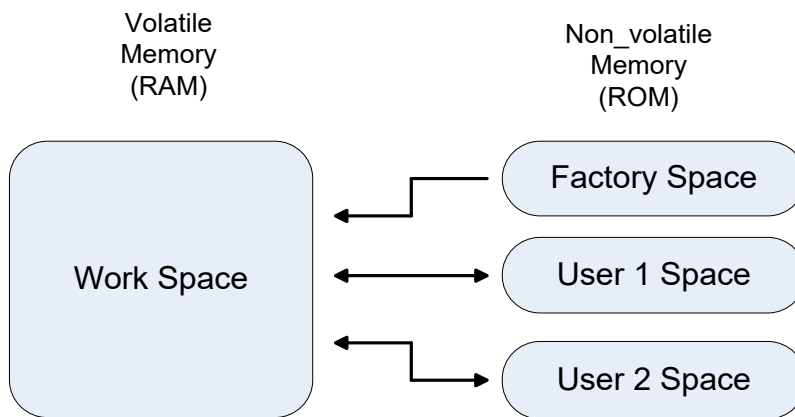

Figure 10-2 Parameter Area

10.4 Command List

Command	Syntax	Return Value	Description
Help	h	String	Display a list of all commands
Set Read-Out Mode	srm 0 1	OK	0: Normal mode
Get Read-Out Mode	grm	0 1	1: ROI (Region of Interest) mode (ROI is set using 'sha' and 'sva' commands.)
Set Horizontal Area	sha n1 n2	OK	n1: Starting point of horizontal direction
Get Horizontal Area	gha	n1 n2	n2: End point of horizontal direction
Set Vertical Area	sva n1 n2	OK	n1: Starting point of vertical direction
Get Vertical Area	gva	n1 n2	n2: End point of vertical direction
Set Trigger Mode	stm 0 1	OK	0: Free Run mode
Get Trigger Mode	gtm	0 1	1: Trigger/Overlap mode
Set Trigger Source	sts 1 2	OK	1: CC1 port input
Get Trigger Source	gts	1 2	2: External input
Set Trigger Polarity	stp 0 1	OK	0: Active low
Get Trigger Polarity	gtp	0 1	1: Active high
Set Exposure Source	ses 0 1	OK	0: Program Exposure (by camera)
Get Exposure Source	ges	0 1	1: Pulse Width (by external trigger input)
Set Exposure Time	set n	OK	n: Exposure Time in μ s
Get Exposure Time	get	n	(Setting range: 10 ~ 7,000,000 μ s)
Set Analog Gain	sag n	OK	n: Analog Gain parameter
Get Analog Gain	gag	n	(Setting range: 0 ~ 63)
Set Analog Offset	sao n	OK	n: Analog Offset parameter
Get Analog Offset	gao	n	(Setting range: 0 ~ 63)
Set Test Image	sti 0 1 2 3	OK	0: Off
Get Test Image	gti	0 1 2 3	1, 2: Fixed pattern image 3: Moving pattern image
Set Data Bit	sdb 8 10	OK	8: 8 bit output
Get Data Bit	gdb	8 10	10: 10 bit output
Set Strobe Offset	sso n	OK	n: Strobe Offset time in microseconds
Get Strobe Offset	gso	n	(Setting range: 0 ~ 100,000 μ s, Only available on VC-25MC)
Set Strobe Polarity	ssp 0 1	OK	0: Active low
Get Strobe Polarity	gsp	0 1	1: Active high

Table 10.1 Command List #1

Command	Syntax	Return Value	Description
Generate Offset Calibration Data	god	OK	Generate offset calibration data to the volatile memory
Save Offset Calibration Data	sod	OK	Save offset calibration data to the flash memory
Load Offset-Calibration Data	lod	OK	Load offset calibration data from the flash memory (Calibration data is loaded automatically at the start-up status)
Set Defect Correction	sdc 0 1	OK	0: Off
Get Defect Correction	gdc	0 1	1: Active of Defect Correction
Set Camera-Link Mode	scl 0 1 2 3	OK	0: 2 Tap output
Get Camera-Link Mode	gcl	0 1 2 3	1: 4 Tap output
			2: 8 Tap output
			3: 10 Tap output
Set Binning Factor	sbf 1 2	OK	1: binning off
Get Binning Factor	gbf	1 2	2: 2 by 2 binning

Table 10.2 Command List #2

Command	Syntax	Return Value	Description
Save Config To	sct 1 2	OK	1: Save to User 1 Setting 2: Save to User 2 Setting
Load Config From	lcf 0 1 2	OK	0: Load from Factory Setting 1: Load from User 1 Setting 2: Load from User 2 Setting
Set Config Initialization	sci 0 1 2	OK	0: Load from Factory Setting when initializing
Get Config Initialization	gci	0 1 2	1: Load from User 1 Setting when initializing 2: Load from User 2 Setting when initializing
Get Model Name	gmn	String	Display Model Name
Get MCU Version	gmv	String	Display MCU version
Get FPGA Version	gfv	String	Display FPGA version
Get Serial Number	gsn piece	String	Display Serial Number
Get Current Temperature	gct	String	Display Temperature value

Table 10.3 Command List #3

Command	Syntax	Return Value	Description
Set Region Select	srs n	OK	n: Region number (0 - 31)
Get Region Select	grs	n	
Set Region Mode (current region)	src 0 1	OK	0: Region Off
Get Region Mode (current region)	grc	0 1	1: Region On
Set Offset X	sox n	OK	n: X axis offset
Get Offset X	gox	n	
Set Offset Y (current region)	soy n	OK	n: Y axis offset
Get Offset Y (current region)	goy	n	
Set Width	siw n	OK	n: Width value
Get Width	giw	n	
Set Height (current region)	sih n	OK	n: Height value
Get Height (current region)	gih	n	
Update Multi-ROI	ast	OK	Update multi-ROI settings
Set RGB Gain	srg r g b f	OK	f: Gain parameter
Get RGB Gain	grg r g b	f	
Auto generation RGB Gain	arg	OK	

Table 10.4 Command List #4 (VC-12MC/VC-25MC Only)

Command	Syntax	Return Value	Description
Set FFC Target Level	sftl n	OK	n: Target Level (0 ~ 255 DN)
Get FFC Target Level	gftl	n	(Only available on VC-25MC-30 D)
Generate Flat Field Data	gfd	OK	Operate Flat Field generator
Save Flat Field Data	sfd	OK	Save Flat Field data
Load Flat Field Data	lfd	OK	Load Flat Field data
Set Flat Field Correction	sfc 0 1	OK	0: Off
Get Flat Field Correction	gfc	0 1	1: Active of Flat Field Correction
Set Flat-Field Selector	sfs n	OK	n: Flat Field data index number Setting range: <ul style="list-style-type: none"> • VC-12MC/VC-25MC: 0 ~ 3 • VC-25MC-30 D: 0 ~ 9 (Only available on VC-12MC/VC-25MC)
Get Flat-Field Selector	gfs	n	

Table 10.5 Command List #5 (Flat Field Correction)

Command	Syntax	Return Value	Description
Set HDR Mode	shm 0 1	OK	0: Normal mode
Get HDR Mode	ghm	0 1	1: High Dynamic Range mode
Set High Dynamic range	shd n	OK	n: Dynamic range in dB (Setting range: 0 ~ 40 dB)

Table 10.6 Command List #6 (High Dynamic Range)

Command	Syntax	Return Value	Description
Set Sequencer Mode	sssm 0 1	OK	0: Sequencer Mode Off
Get Sequencer Mode	gssm	0 1	1: Sequencer Mode On
Set Sequencer Set Count	sssc n	OK	n: The number of Sequencer Set to apply (1 ~ 30)
Get Sequencer Set Count	gssc	n	
Set Sequencer Set Selector	ssss n m	OK	n: Index of Sequencer Set (0 ~ 29)
Get Sequencer Set Selector	gsss n	m	m: Index of FFC data (0 ~ 9)
Reset Sequencer	rssc	OK	Returns to Sequencer Set 0.
Reset Flat Field Data	rfd	OK	Clears the selected FFC data.

Table 10.7 Command List #7 (Sequencer – VC-25MC-30 D Only)

11 Configurator GUI

Configurator, a sample application, is provided to control VC Series camera. Configurator provides easy-to-use Graphic User Interface (GUI) for the user while using the commands mentioned previous chapters.

11.1 Camera Scan

When you execute the program while the camera is turned on, Camera Scan window appears as shown in the figure below. At this time, the program checks serial port of computer and DLL provided by Camera Link to scan whether the camera is connected. If there is a camera connected, it displays model name on the screen. If the camera is not properly displayed on the screen, check the connection of cable with power of camera and press the **refresh** button. When you double-click model name displayed on the screen, Configurator is executed and displays current setting value of camera connected.

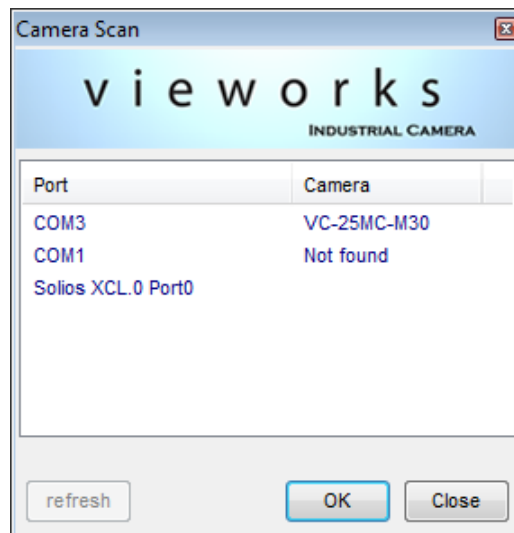

Figure 11-1 Configurator Loading Window

11.2 Menu

11.2.1 File

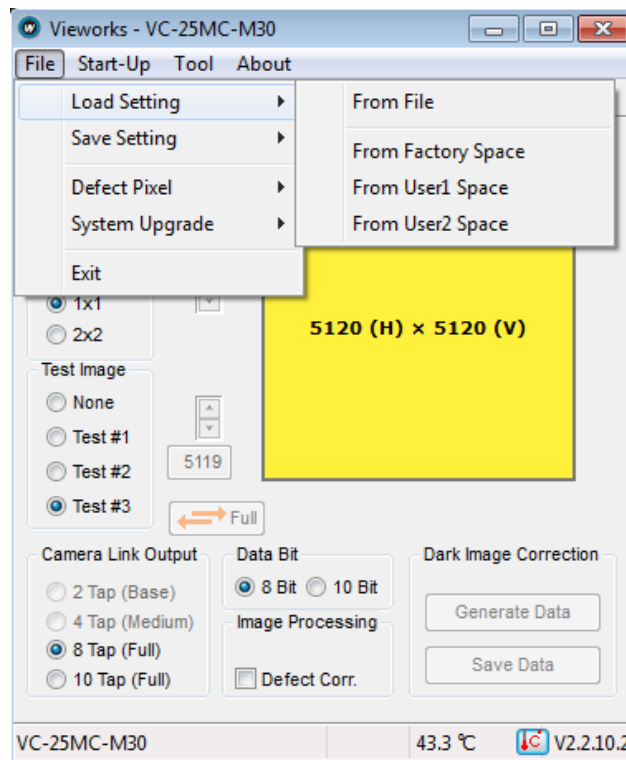

Figure 11-2 File Menu

- **Load Setting:** Loads the camera setting value from the camera memory (Factory, User1, User2) or user computer (From File).
- **Save Setting:** Saves the camera setting values to the camera memory (User1 or User2) or user computer (To File).
- **Defect Pixel:** Downloads defect information to the camera (Download to Camera) or uploads defect information saved in the camera to user computer (Upload to PC).
- **System Upgrade:** Upgrades MCU program or FPGA logic.
- **Exit:** Exits Configurator.

11.2.2 Start-Up

You can select the camera setting values to load when the camera is turned on.

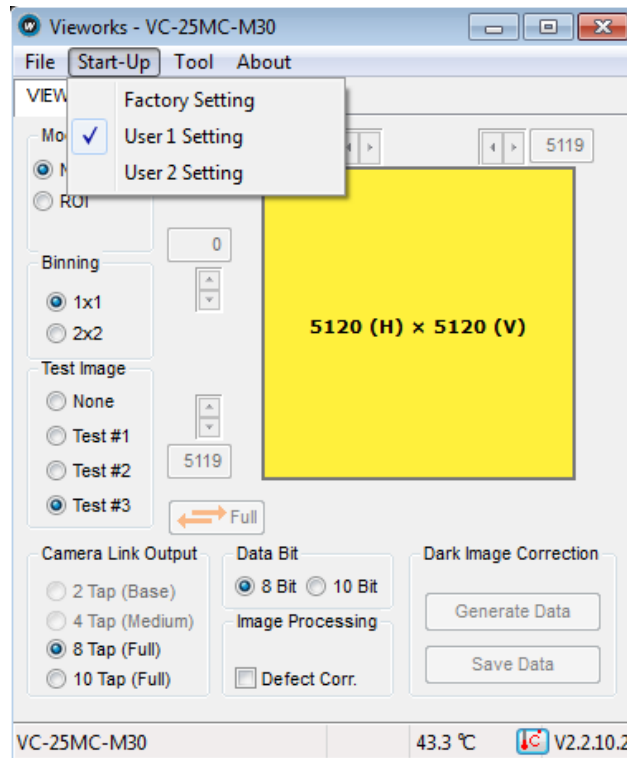

Figure 11-3 Start-Up Menu

- **Factory Setting:** Loads the camera setting values from Factory Space.
- **User1 Setting:** Loads the camera setting values from User1 Space.
- **User2 Setting:** Loads the camera setting values from User2 Space.

11.2.3 Tool

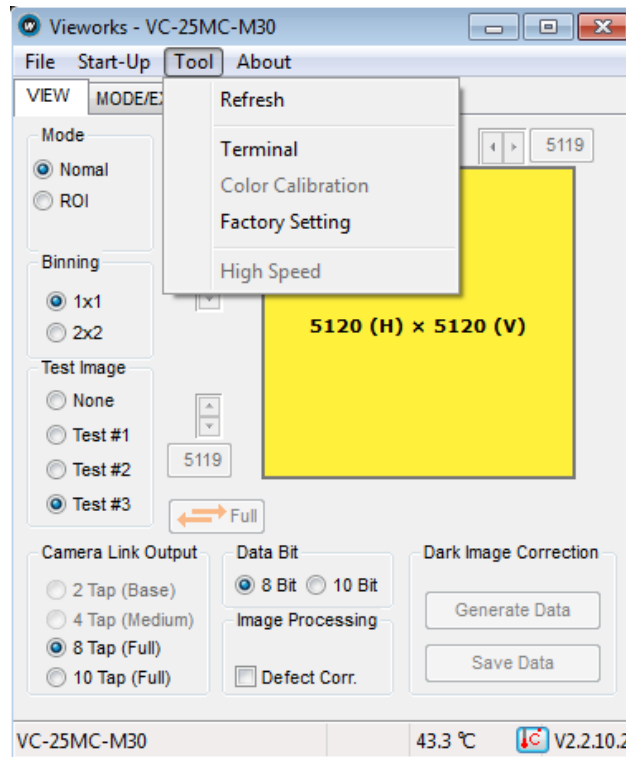

Figure 11-4 Tool Menu

- **Refresh:** Loads and displays the current camera setting values on Configurator.
- **Terminal:** Displays user commands in Terminal window under GUI.
To hide Terminal window, uncheck **Terminal** by clicking again.
- **Color Calibration:** Displays the **Color Calibration** window for Bayer sensor color temperature Calibration (VC-12MC/VC-25MC Only). When you click the **Auto White Balance** button, white balance is adjusted once and then Off.

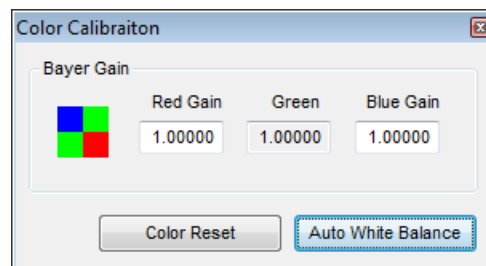

Figure 11-5 Color Calibration (VC-12MC/VC-25MC Only)

- **Factory Setting:** Not supported in the user side.
- **High Speed:** Not supported on VC Series.

11.2.4 About

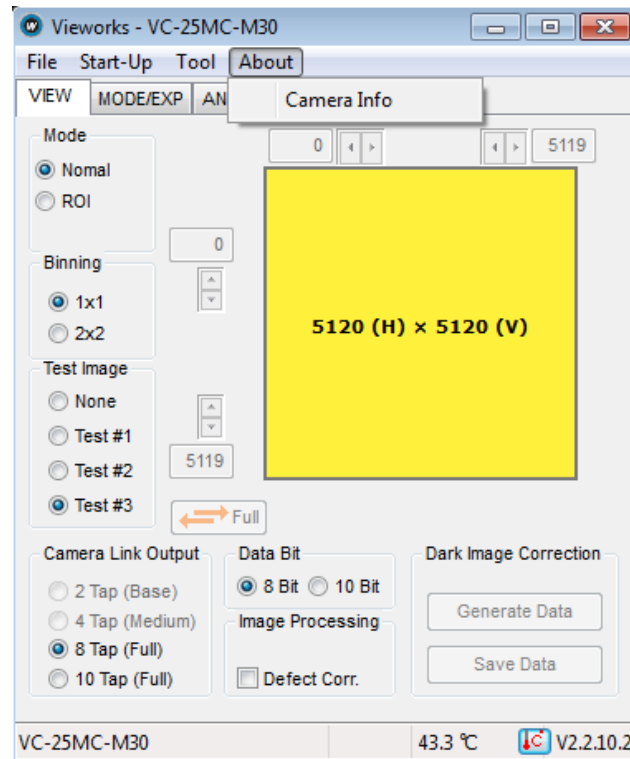

Figure 11-6 About Menu

- **Camera Info:** Displays camera information (product name, serial number, version, etc).

11.3 Tab

11.3.1 VIEW tab

VIEW tab allows you to set the camera readout mode, test image mode, data bit, channel, LUT, image processing, etc.

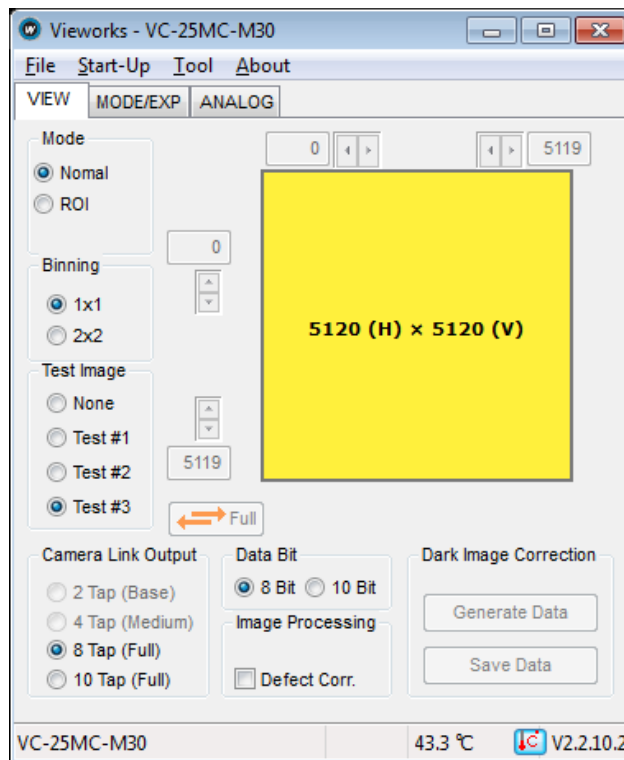

Figure 11-7 VIEW Tab

- Mode:** Selects readout mode. If ROI is selected, ROI setting area is activated and ROI can be set by entering desired values. If Binning is selected, ×2 option button is activated (Supported only on VC-25MC).
- Test Image:** Selects whether to apply test image and the type of test image.
- Camera Link Output:** Selects Camera Link output mode.
- Data Bit:** Selects width of data output.
- Image Processing:** Sets Defect Correction feature On or Off.
- Dark Image Correction:** Corrects Fixed Pattern Noise at camera dark image. (Not supported on VC-25MC)

Configurator provides the **VIEW** tab for the VC-12MC/VC-25MC models as follows.

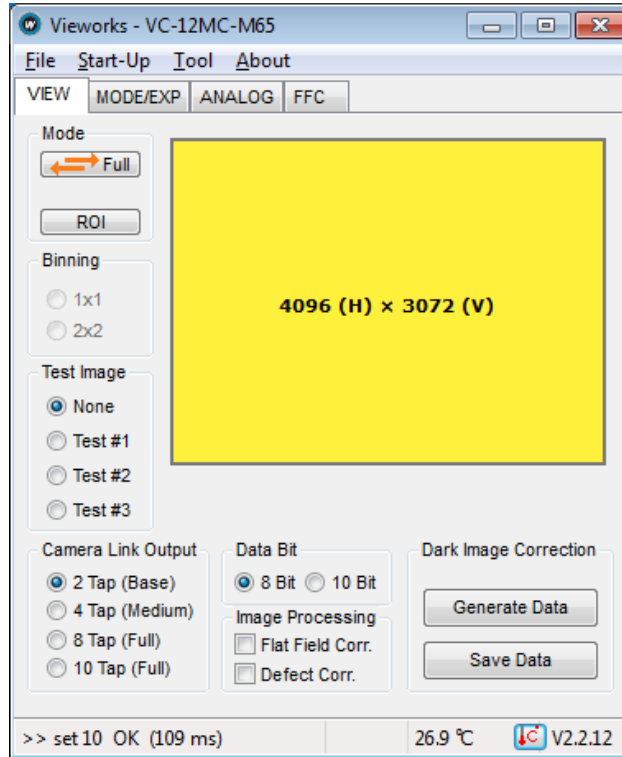

Figure 11-8 VIEW tab for VC-12MC

- **Full:** Disables the Multi-ROI feature and set to its full resolution.
- **ROI:** Displays the **Setting Multi-ROI** window for setting Multi-ROI.

Multi-ROI on VC-12MC

Num	Offset X	Offset Y	Width	Height	Status
0	0	0	4096	3072	ON
1	0	0	4096	3072	OFF
2	0	0	4096	3072	OFF
3	0	0	4096	3072	OFF
4	0	0	4096	3072	OFF
5	0	0	4096	3072	OFF
6	0	0	4096	3072	OFF
7	0	0	4096	3072	OFF
8	0	0	4096	3072	OFF
9	0	0	4096	3072	OFF
10	0	0	4096	3072	OFF

Multi-ROI on VC-25MC

Num	Offset X	Offset Y	Width	Height	Status
0	0	0	5120	5120	ON
1	0	0	5120	5120	OFF
2	0	0	5120	5120	OFF
3	0	0	5120	5120	OFF
4	0	0	5120	5120	OFF
5	0	0	5120	5120	OFF
6	0	0	5120	5120	OFF
7	0	0	5120	5120	OFF
8	0	0	5120	5120	OFF
9	0	0	5120	5120	OFF
10	0	0	5120	5120	OFF

Figure 11-9 Setting Multi-ROI

- **Flat Field Correction:** Sets the **Flat Field Correction** feature On or Off.

11.3.2 MODE/EXP Tap

MODE/EXP tab allows you to select trigger mode, exposure time and strobe.

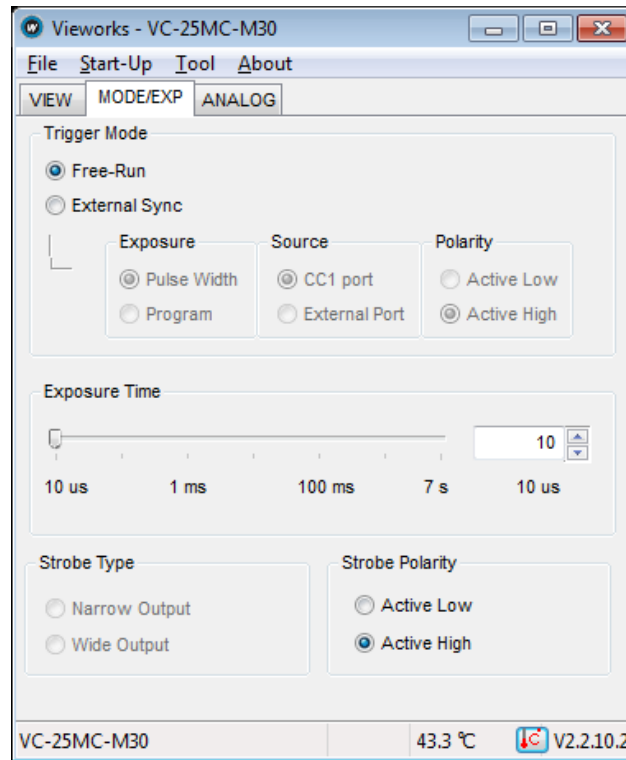

Figure 11-10 MODE/EXP Tab

- **Trigger Mode:** Selects trigger mode. Once a mode has been selected, related selections will be activated.
- **Exposure:** Selects exposure source.
- **Source:** Selects trigger source.
- **Polarity:** Selects polarity of trigger input.
- **Exposure Time:** Sets exposure time when trigger mode is set with Free-Run mode or when Exposure is set with program.
- **Strobe Type:** Sets strobe type.
- **Strobe Polarity:** Sets the polarity of strobe output signal.

11.3.3 ANALOG Tab

ANALOG tab allows you to set gain and offset settings of the image.

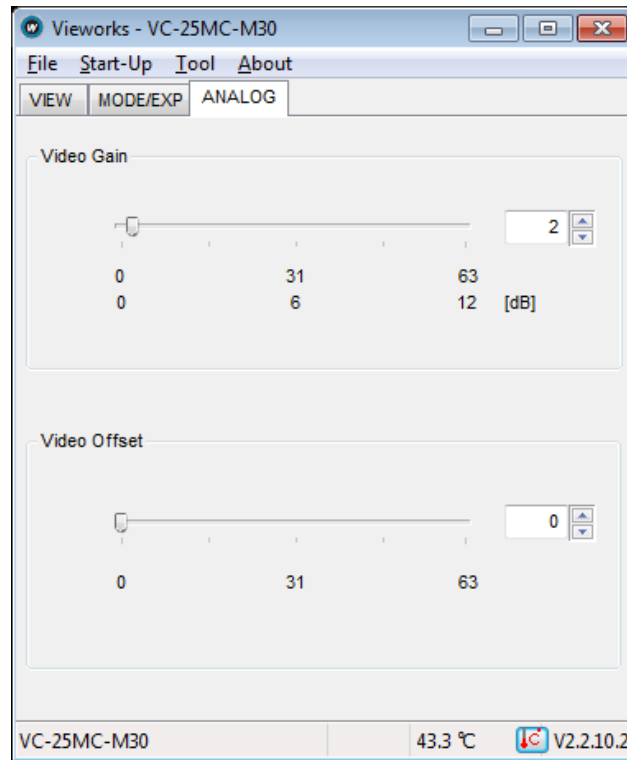

Figure 11-11 ANALOG Tab

- **Video Gain:** Sets a gain value.
- **Video Offset:** Sets an offset value.

11.3.4 FFC Tab

Configurator provides the **FFC** tab for the VC-2MC-340, VC-4MC-180, VC-12MC-65, VC-25MC-30 and VC-25MC-30 D models as follows.

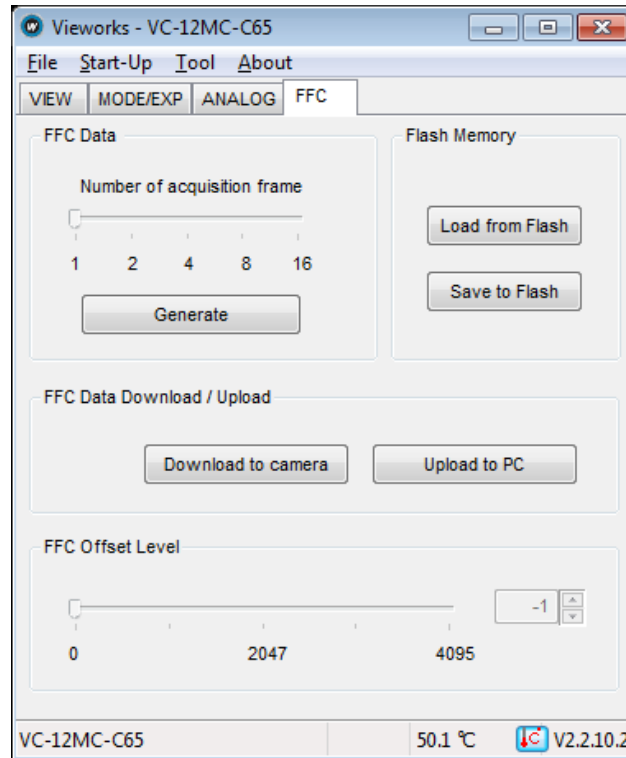

Figure 11-12 FFC Tab

- **FFC Data:** Generates the Flat Field Correction data to be used for correction. You can set only one frame for correction.
- **Flash Memory:** Saves (Save to Flash) the generated FFC data to Flash in order to reuse in the future or loads (Load From Flash) the saved FFC data.
- **FFC Data Download / Upload:** Downloads (Download to camera) FFC data from the user computer or uploads (Upload to PC) FFC data to the user computer.
- **FFC Offset Level:** Sets the offset value of the image after applying the Flat Field Correction.

12 Troubleshooting

- If no image is displayed on the screen,
 - Ensure that all the cable connections are secure.
 - Ensure that the power supply is properly connected.
 - Ensure that trigger signal is applied correctly when you use external trigger mode.

- If images are not clear,
 - Ensure the camera lens or glass is clean.
 - Check that the lens aperture is adjusted properly.

- If images are dark,
 - Ensure that your camera lens is not blocked.
 - Check that exposure time is set properly.

- If you identify abnormal operation or overheating sign,
 - Ensure that the power supply is properly connected.
 - Stop using the camera when you notice smoke or abnormal overheating.

- If the trigger mode is not working correctly,
 - Ensure that CC1 setting on the grabber board is configured correctly when you use CC1 trigger mode.
 - Ensure that cable connections are secure when you use external trigger mode.

- If you identify the difference between left and right image,
 - Check whether left and right gain settings are different.
 - Check whether left and right offset settings are different.

- If there is a communication failure between the camera and PC,
 - Ensure that the camera link cable is connected properly.
 - Ensure that serial communication settings are configured properly on both PC and frame grabber.

Appendix A Defective Pixel Map Download

1. Create the Defective Pixel Map data in Microsoft Excel format as shown in the left picture below and save as a CSV file (*.csv). The picture in the right shows the created Excel file opened in Notepad. The following rules need to be applied when creating the file.
 - Lines beginning with ':' or '--' are treated as notes.
 - You must enter the horizontal value first and then the vertical value for coordinate of each defect pixel.
 - Coordinate values for each pixel can be placed in any order.

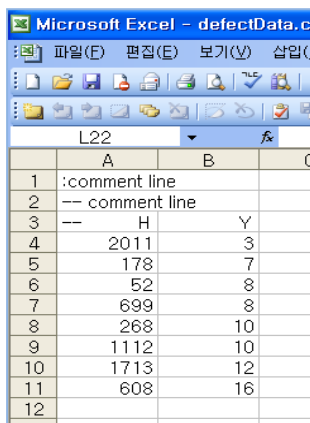

	A	B	C
1	:comment line		
2	-- comment line		
3	-- H	Y	
4	2011	3	
5	178	7	
6	52	8	
7	699	8	
8	268	10	
9	1112	10	
10	1713	12	
11	608	16	
12			

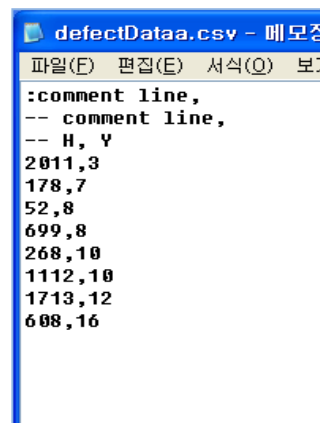

```

defectDataa.csv - 메모장
파일(F) 편집(E) 서식(O) 보...
:comment line,
-- comment line,
-- H, Y
2011,3
178,7
52,8
699,8
268,10
1112,10
1713,12
608,16
  
```

2. Select **File > Defect Pixel > Download to Camera** on Configurator.

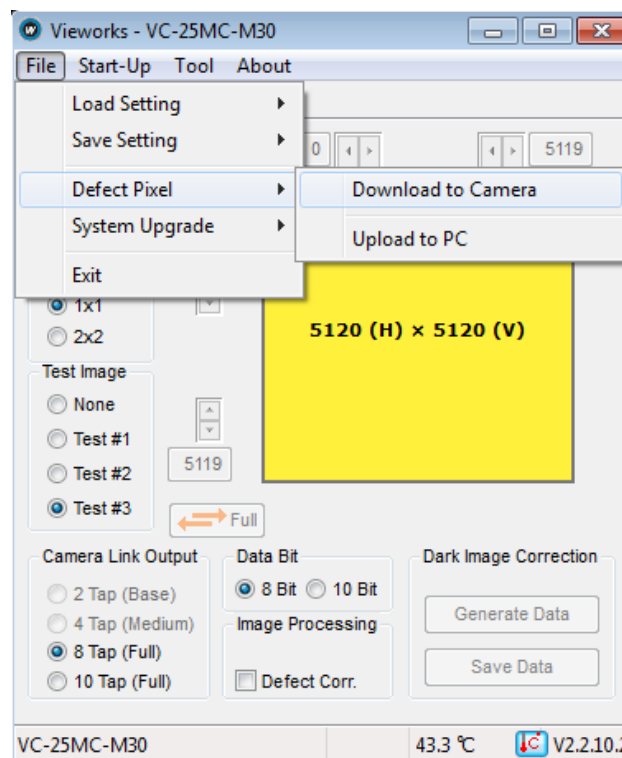

3. Search and select the created file and click **Open**.

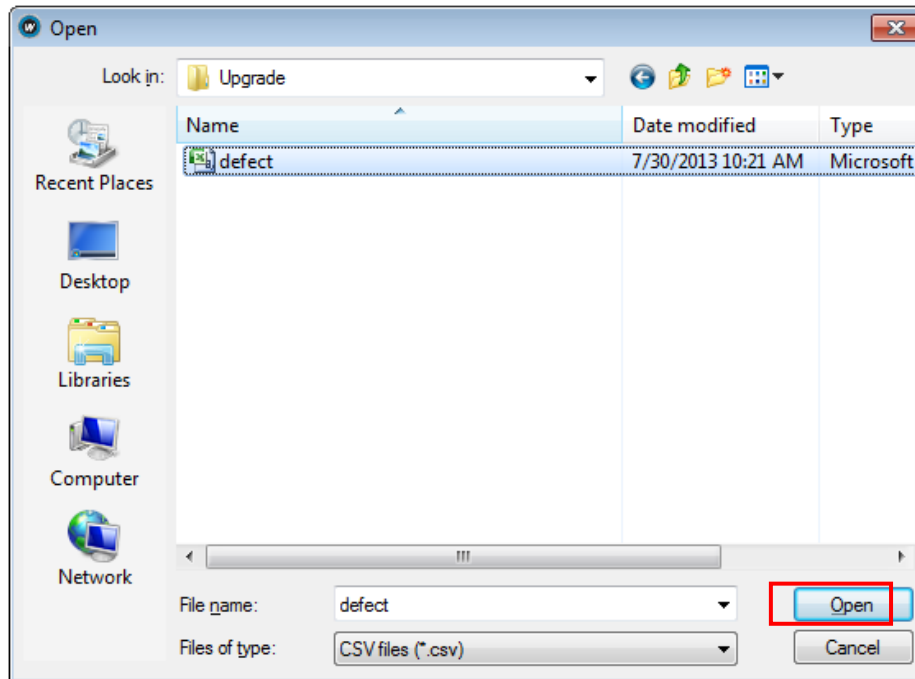

4. Configurator starts downloading defective pixel map data to the camera and downloading status is displayed at the bottom of the window.

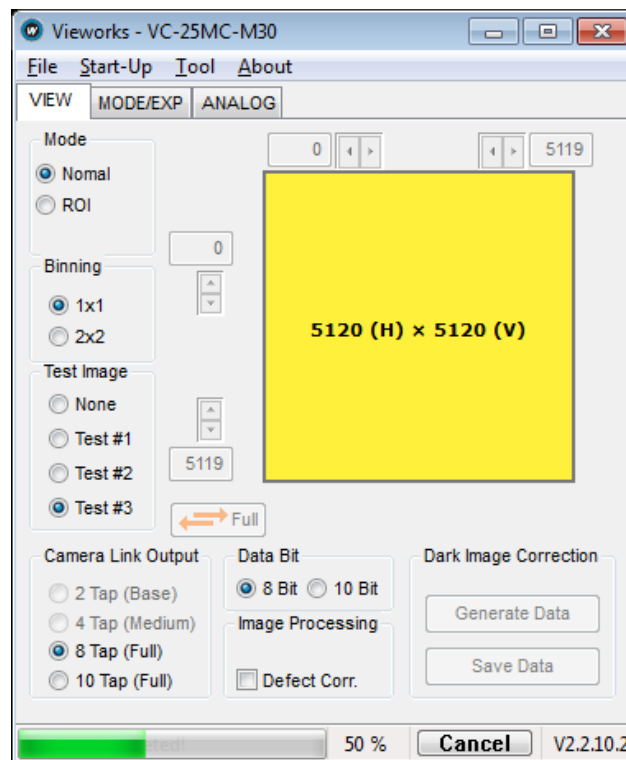

- Once the download has been completed, the saving process will begin. During the saving process, make sure not to disconnect the power cord.
- Once all the processes have been completed, **Download completed** message will appear at the bottom of the window.

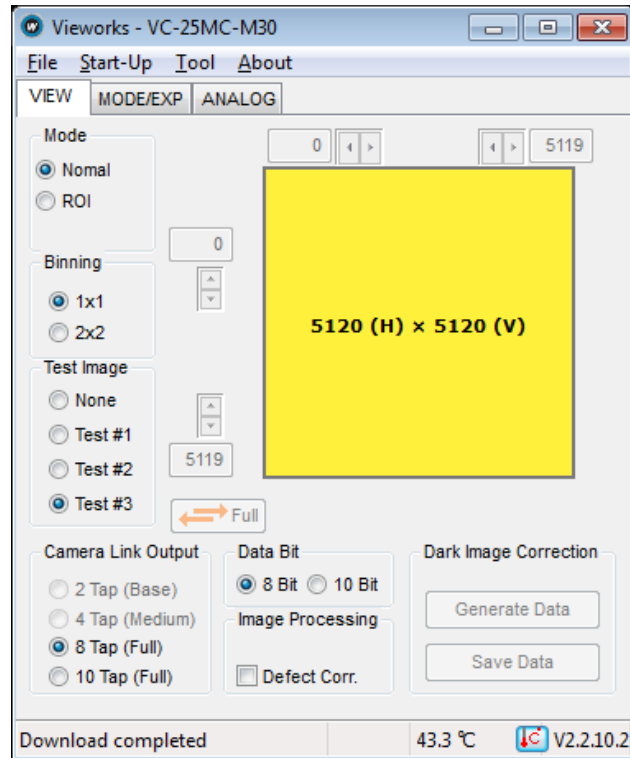

Appendix B Field Upgrade

B.1 MCU

1. Select **File > System Upgrade > MCU Upgrade** on Configurator.

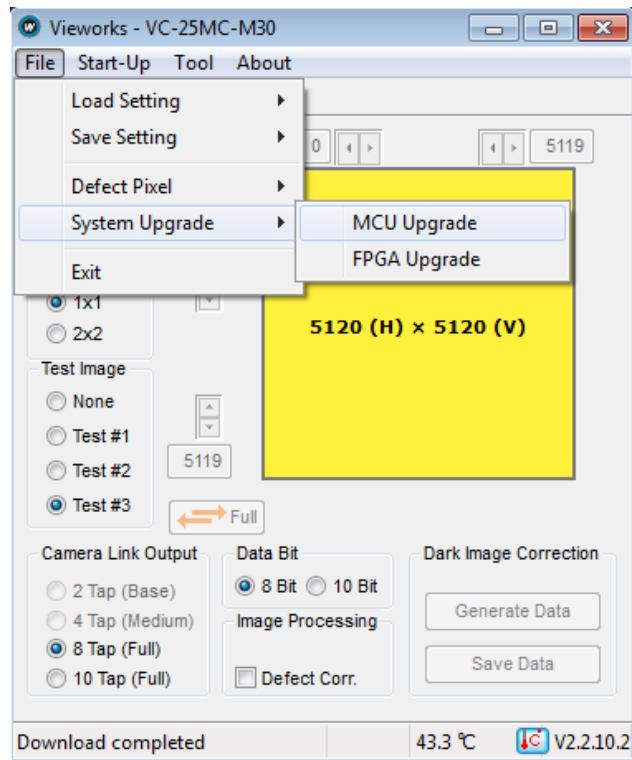

2. Search and select the provided MCU upgrade file, and then click **Open**.

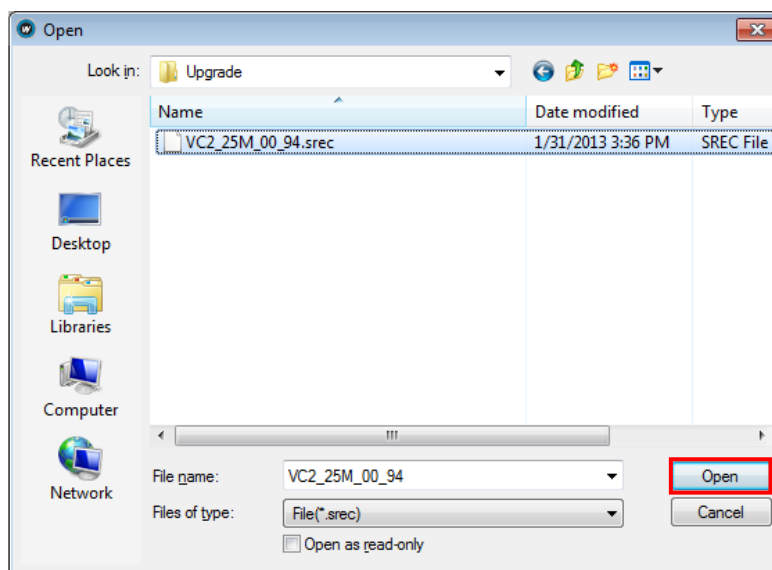

- Configurator starts downloading MCU upgrade file to the camera and downloading status is displayed at the bottom of the window. This process may require several minutes to complete. If you want to cancel the upgrade process, click **Cancel**.

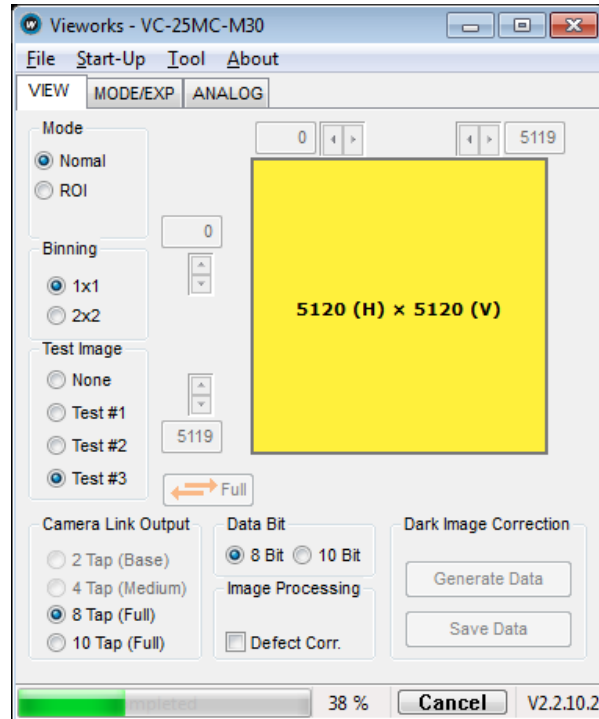

- Once the download has been completed, the saving process will begin. During the saving process, the camera cannot be restored if a power failure occurs. Make sure that the power connection is secure.

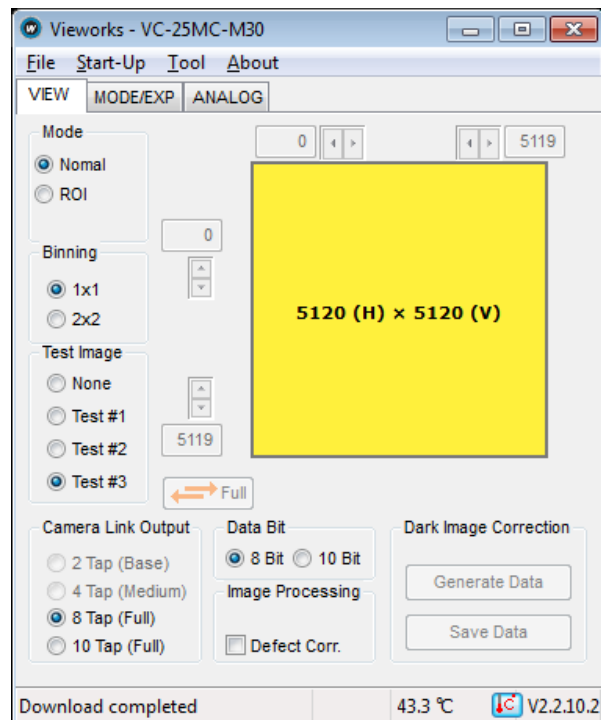

5. Once all the processes have been completed, turn the power off and turn it back on again. Select **Tool** > **Terminal** and enter the 'gmv' command to confirm the version. Or, select **About** > **Camera Info** to confirm the MCU version.



B.2 FPGA

1. Select **File > System Upgrade > FPGA Upgrade** on Configurator.

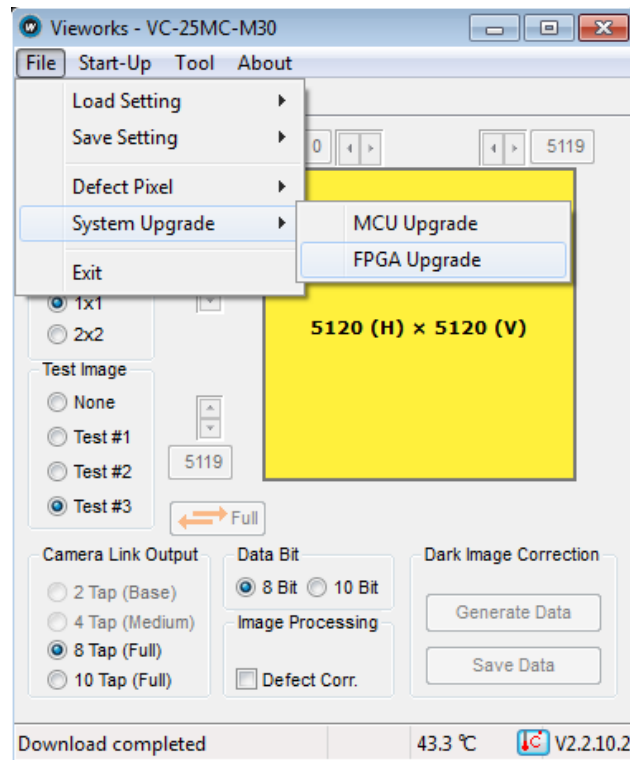

2. Search and select the provided FPGA upgrade file and click **Open**.

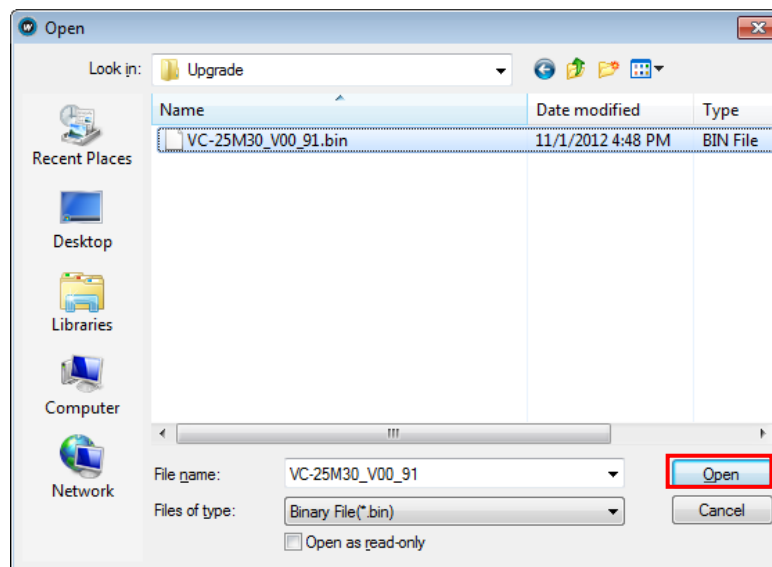

3. The subsequent processes are identical to those of MCU upgrade.

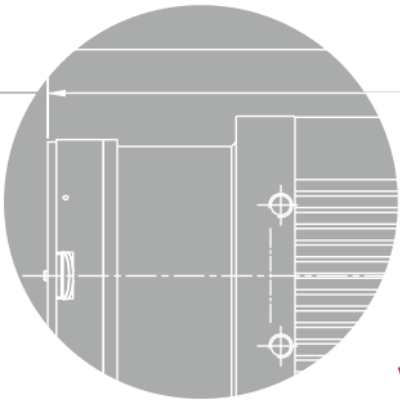
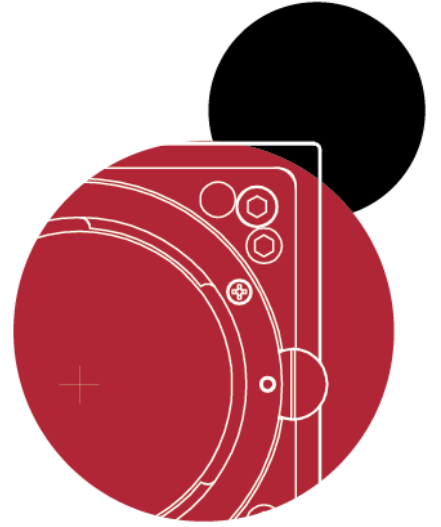
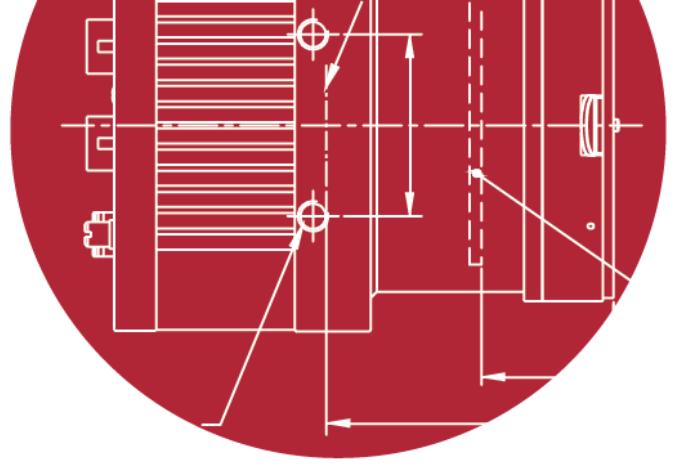

Vieworks Co., Ltd.

41-3, Burim-ro, 170beon-gil,
Dongan-gu, Anyang-si, Gyeonggi-do
14055 Republic of Korea

Tel: +82-70-7011-6161

Fax: +82-31-386-8631

<http://vision.vieworks.com>

vision@vieworks.com