

VT series

User Manual

English

VT-16K5X2-E300A-64
VT-16K5X2-H300A-256

CoaXPress[®]

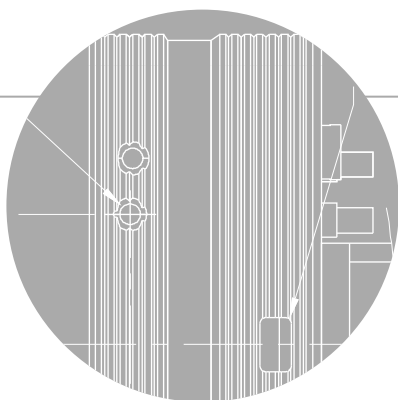

VIEWWORKS

Preface

No part of this manual may either be copied, reproduced, translated, or published in any form or by any means (electronic, mechanical, photocopying, or otherwise) without the express written permission of Vieworks, Co., Ltd. (hereinafter 'Vieworks').

This manual may include the website links to companies other than Vieworks. Vieworks is not responsible for any of these links. The copyrights of the materials mentioned herein are owned by each respective author.

Although Vieworks made every effort to ensure the accuracy of this document, it assumes no responsibility for errors or omissions that may appear herein. The figures in this manual may differ depending on the version of the product or operating system, or the way how it runs. Information in this manual is subject to change without notice.

Before Using This Product

Thank you for choosing VT-16K5X2™.

- Make sure to read this manual before using the product.
- Make sure to check whatever a professional engineer has finished installation and configuration.
- Make sure to keep this manual at hand as a reference while using the product.
- This manual assumes that you have expertise in how to use an industrial camera.

The Series

This manual is intended for users of the following products:

- VT-16K5X2-E300A-64
- VT-16K5X2-H300A-256

About This Manual

This manual is intended for VT-16K5X2™ camera users. It is recommended to refer to the Frame Grabber's User Manual of yours, with this manual.

Convention in This Manual

For better understanding, the following conventions are used throughout the manual.

Names and Fonts

The names and fonts of user interfaces are used as follows:

- The menu and icon names in this manual are used as displayed in the product.
- The menu and icon names are marked in this font.
- Button or keyboard key names are marked in this font.

Warning, Caution, and Note

This manual shows warnings, cautions, and notes with the following figures:

**Warning!**

This indicates that you need to follow this message for your safety and to prevent the product from damage.

**Caution!**

This indicates that you need to follow this message to prevent data from being lost or corrupted.

**Note:**

This indicates that this message provides additional information.

Definition of Terms

For clarity, this manual defines some terms as follows:

Term	Definition
Preface	The introductory part preceding the Table of Contents in this manual
Application	A program that performs a particular task or set of tasks
Configurator	A sample application offered by Vieworks to control the cameras of the VT-16K5X2

Revision History

This document has the revision history as follows:

Version	Date	Description
1.0	2022-07-19	Initial Release

Contents

Chapter 1. Precautions	15
Chapter 2. Warranty	17
Chapter 3. Compliance & Certifications	18
3.1 FCC Compliance.....	18
3.2 CE : DoC.....	18
3.3 KC	18
Chapter 4. Package Components.....	19
Chapter 5. Product Specifications.....	20
5.1 Overview.....	20
5.2 Specifications	21
5.3 Camera Block Diagram	22
5.4 Quantum Efficiency.....	23
5.5 Mechanical Specification	24
5.5.1 Camera Mounting and Heat Dissipation	25
Chapter 6. Connecting the Camera.....	26
6.1 Precaution to Center the Image Sensor	27
6.2 Installing Vieworks Imaging Solution	27
Chapter 7. Camera Interface.....	28
7.1 General Description.....	28
7.2 CoaXPress Connector	29
7.2.1 Micro-BNC Connector.....	29
7.3 Power Input Receptacle.....	30
7.4 Control Receptacle.....	30
7.5 Trigger/Direction Input Circuit	32
7.6 Strobe Output Circuit	32
Chapter 8. Acquisition Control.....	33
8.1 Acquisition Start/Stop Commands and Acquisition Mode.....	33
8.2 Line Start Trigger	34

8.2.1	Trigger Mode	34
8.2.2	Using an External/CoaXPress Trigger Signal	36
8.2.3	Trigger Multiplier/Divider.....	38
8.3	Maximum Allowed Line Rate.....	40
Chapter 9. Camera Features.....		41
9.1	Device Scan Type	41
9.2	TDI Stages.....	42
9.3	Scan Direction.....	43
9.4	Region of Interest	44
9.5	Binning.....	46
9.6	Pixel Format.....	47
9.7	Data ROI	48
9.8	Gain and Black Level	49
9.9	Optical Black Clamp.....	49
9.10	LUT.....	50
9.11	Dark Signal Non-uniformity Correction	52
9.11.1	Generating and Saving User DSNU Correction Values	53
9.12	Photo Response Non-uniformity Correction	54
9.12.1	Generating and Saving User PRNU Correction Values	55
9.13	FPN Coefficients Control	56
9.14	CXP Link Configuration.....	57
9.15	Digital I/O Control	58
9.16	Debounce.....	60
9.17	Temperature Monitor.....	60
9.18	Status LED.....	61
9.19	Test Pattern	61
9.20	Reverse X.....	64
9.21	Counter Control	65
9.22	Timer Control	67
9.23	Device User ID	68
9.24	Device Reset	68

9.25	Field Upgrade	69
9.26	User Set Control	69
Chapter 10. Troubleshooting.....		71
Appendix A. Field Upgrade.....		72
Appendix B. LUT Download		73
B.1	Gamma Graph Download	73
B.2	CSV File Download	75
Appendix C. Index		77

Tables

Table 5-1	Specifications of VT-16K5X2-E300A-64 and VT-16K5X2-H300A-256	21
Table 7-1	Channel Assignments for Micro-BNC Connector	29
Table 7-2	Pin Configurations for Power Input Receptacle	30
Table 7-3	Pin Configurations for Control Receptacle	31
Table 8-1	XML Parameters related to Trigger Multiplier/Divider Mode	39
Table 8-2	Maximum Allowed Line Rates (8 bit)	40
Table 9-1	XML Parameters related to Device Scan Type	41
Table 9-2	XML Parameters related to Device Scan Type	41
Table 9-3	XML Parameters related to TDI Stages	42
Table 9-4	The number of available TDI Stages for each camera model	42
Table 9-5	XML Parameters related to Scan Direction	43
Table 9-6	XML Parameters related to ROI	44
Table 9-7	XML Parameters related to Binning	46
Table 9-8	XML Parameter related to Pixel Format	47
Table 9-9	Pixel Format Values	47
Table 9-10	XML Parameters related to Data ROI	48
Table 9-11	XML Parameters related to Gain and Black Level	49
Table 9-12	XML Parameters related to Optical Black Clamp	49
Table 9-13	XML Parameters related to LUT	51
Table 9-14	XML Parameters related to DSNU	52
Table 9-15	XML Parameters related to PRNU	54
Table 9-16	XML Parameters related to FPN Coefficients Control	56
Table 9-17	XML Parameters related to CXP Link Configuration	57
Table 9-18	XML Parameters related to Digital I/O Control	58

Table 9-19	XML Parameters related to Device Temperature.....	60
Table 9-20	Status LED	61
Table 9-21	XML Parameter related to Test Pattern.....	61
Table 9-22	XML Parameter related to Reverse X	64
Table 9-23	XML Parameters related to Counter Control (1).....	65
Table 9-24	XML Parameters related to Counter Control (2).....	66
Table 9-25	XML Parameters related to Timer Control.....	67
Table 9-26	XML Parameter related to Device User ID.....	68
Table 9-27	XML Parameter related to Device Reset	68
Table 9-28	XML Parameters related to User Set Control	69

Figures

Figure 5-1	Camera Block Diagram.....	22
Figure 5-2	Quantum Efficiency	23
Figure 5-3	VL Series Mechanical Dimension.....	24
Figure 7-1	VT-16K5X2 Cameras' Back Panel	28
Figure 7-2	Micro-BNC Connector	29
Figure 7-3	Pin Assignments for Power Input Receptacle	30
Figure 7-4	Pin Assignments for Control Receptacle	31
Figure 7-5	Trigger/Direction Input Schematic	32
Figure 7-6	Strobe Output Schematic	32
Figure 8-1	Trigger Mode = Off	35
Figure 8-2	Trigger Mode = On	36
Figure 8-3	Trigger Ratio = 0.5	38
Figure 9-1	Scan Direction.....	43
Figure 9-2	Region of Interest.....	44
Figure 9-3	Sensor Binning	46
Figure 9-4	Effective Data ROI.....	48
Figure 9-5	LUT Block	50
Figure 9-6	LUT at Gamma 0.5.....	51
Figure 9-7	CXP Link Configuration	57
Figure 9-8	User Output	59
Figure 9-9	Exposure Active Signal.....	59
Figure 9-10	Debounce	60
Figure 9-11	Grey Horizontal Ramp.....	62
Figure 9-12	Grey Diagonal Ramp.....	62

Figure 9-13 Grey Diagonal Ramp Moving63

Figure 9-14 Sensor Specific63

Figure 9-15 Original Image64

Figure 9-16 Reverse X Image.....64

Figure 9-17 Timer Signal.....68

Figure 9-18 User Set Control.....70

Chapter 1. Precautions

General



- Do not drop, disassemble, repair or alter the device. Doing so may damage the camera electronics and cause an electric shock.
- Do not let children touch the device without supervision.
- Stop using the device and contact the nearest dealer or manufacturer for technical assistance if liquid such as water, drinks or chemicals gets into the device.
- Do not touch the device with wet hands. Doing so may cause an electric shock.
- Make sure that the temperature of the camera does not exceed the temperature range specified in 5.2 Specifications. Otherwise the device may be damaged by extreme temperature.

Installation and Maintenance



- Do not install in dusty or dirty areas - or near an air conditioner or heater to reduce the risk of damage to the device.
- Avoid installing and operating in an extreme environment where vibration, heat, humidity, dust, strong magnetic fields, explosive/corrosive mists or gases are present.
- Do not apply excessive vibration and shock to the device. This may damage the device.
- Avoid direct exposure to a high intensity light source. This may damage the image sensor.
- Do not install the device under unstable lighting conditions. Severe lighting change will affect the quality of the image produced by the device.
- Do not use solvents or thinners to clean the surface of the device. This can damage the surface finish.

Power Supply



- Applying incorrect power can damage the camera. If the voltage applied to the camera is greater or less than the camera's nominal voltage, the camera may be damaged or operate erratically. Please refer to 5.2 Specifications for the camera's nominal voltage.
 - ※ Vieworks Co., Ltd. does NOT provide power supplies with the devices.
- Make sure the power is turned off before connecting the power cord to the camera. Otherwise, damage to the camera may result.

Cleaning the Sensor Surface

Avoid cleaning the surface of the camera's sensor if possible. If you have dust or foreign matter on the sensor surface that will not blow off, use a soft lint free cotton bud dampened with a small quantity of high quality lens cleaner. Because electrostatic discharge (ESD) can damage the sensor, you must use a cloth (e.g. cotton) that will not generate static during cleaning.



Avoid dust or foreign matter on the sensor surface.

The camera is shipped with a protective plastic seal on the camera front. To prevent collecting dust or foreign matter on the camera sensor, make sure that you always put the protective seal in place when there is no lens mounted on the camera. In addition, make sure to always point the camera downward when there is no protective seal on the camera front or no lens mounted.

Procedures for Cleaning the Sensor

If you have dust or foreign matter on the sensor surface, follow the procedures below to wipe off.

1. Remove a contaminant by using an ionizing air gun.
If this step does not remove the contaminant, proceed to the next step.
2. Clean the contaminant on the sensor using one drop of lens cleaner on a non-fluffy cotton bud.
3. Wipe the cotton bud gently in only one direction (either left to right or right to left). Avoid wiping back and forth with the same cotton bud in order to ensure that the contaminants are removed and not simply transferred to a new location on the sensor surface.
4. Mount a lens, set the lens at a smaller aperture (e.g. F8), and then acquire images under bright lighting conditions. Check the images on the monitor for dark spots or stripes caused by the contaminant. Repeat the steps above until there is no contaminant present.



Caution!

If the sensor is damaged due to electrostatic discharge or the sensor surface is scratched during cleaning, the warranty is void.

Chapter 2. Warranty

Do not open the housing of the camera. The warranty becomes void if the housing is opened. For information about the warranty, please contact your local dealer or factory representative.

Chapter 3. Compliance & Certifications

3.1 FCC Compliance

This equipment has been tested and found to comply with the limits for a Class A digital device, pursuant to part 15 of the FCC Rules. These limits are designed to provide reasonable protection against harmful interference when the equipment is operated in a commercial environment. This equipment generates, uses, and can radiate radio frequency energy and, if not installed and used in accordance with the instruction manual, may cause harmful interference to radio communications. Operation of this equipment in a residential area is likely to cause harmful interference in which case the user will be required to correct the interference at his own expenses.

3.2 CE : DoC

EMC Directive 2014/30/EU

EN 55032:2012 (Class A), EN 55024:2010

Class A

3.3 KC

KCC Statement

Type	Description
Class A (Broadcasting Communication Device for Office Use)	This device obtained EMC registration for office use (Class A), and may be used in places other than home. Sellers and/or users need to take note of this.

Chapter 4. Package Components

Package Components

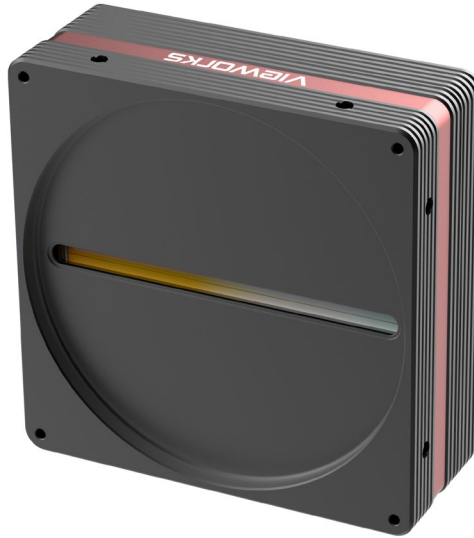

VT-16K5X2-E300A-64/VT-16K5X2-H300A-256 with M95 mount

Chapter 5. Product Specifications

5.1 Overview

The VT-16K5X2 cameras, the new hybrid Time Delayed Integration (TDI) line scan cameras equipped with eight CoaXPress channels, provide faster line rates and higher sensitivity than existing line scan cameras. With hybrid TDI line scan technology combining the strengths of both CCD and CMOS image sensors, the VT-16K5X2-E300A-64 camera delivers line rates of up to 300 kHz at 16k resolution with 64× higher sensitivity. Even superior sensitivity, up to 16384 pixel resolution at a maximum line rate of 300 kHz and 256× greater sensitivity can be achieved using the VT-16K5X2 cameras. Featured with high speed and high sensitivity, these cameras are ideal for demanding applications such as flat panel display inspection, wafer inspection, printed circuit board inspection, and high-performance document scanning.

Main Features

- Hybrid TDI Line Scan
- Max. 16384 × 256 Pixel Resolution
- Bidirectional Operations with up to 256 TDI Stages
- Anti-blooming
- Trigger Rescaler and Strobe Output Control
- CoaXPress2.0 Interface up to 50 Gbps using 4 coax cables (4 CH)
- Advanced PRNU and DSNU Correction
- Area Scan Mode for Camera Alignment

Applications

- Flat Panel Display Inspection
- Printed Circuit Board Inspection
- Wafer Inspection
- High Performance Document Scanning

5.2 Specifications

Technical specifications for the VT-16K5X2 cameras are as follows.

Specification	VT-16K5X2-E300A-64	VT-16K5X2-H300A-256
Active Image(H × V)	16384 × 64	16384 × 256
Sensor Type	Hybrid TDI Line Scan	
Pixel Size	5.0 μm × 5.0 μm	
Interface	CoaXPRESS 2.0 (CXP-12)	
Pixel Data Format	8 / 10 / 12 bit	
TDI Stage	64	64 / 128 / 192 / 256
TDI Direction	External Control Port or Programmable	
Trigger Synchronization	Free-Run, External Trigger Signal, CoaXPRESS Programmable Line Rate and Trigger Polarity	
Max. Line Rate	300 kHz (ROI 16,000 pixels)	
Max. Line Rate (2 × 2 Binning)	257 kHz	
Min. Line Rate	1 kHz	
Throughput	4.8 Gpix/s	
Gamma Correction	User Defined LUT (Look Up Table)	
Black Level	-255 ~ 255 at 8 bit	
Gain Control	Analog Gain: ×1, ×2, ×3, ×4 / Digital Gain: 1.0× ~ 8.0×	
External Trigger	External, 3.3 V – 5.0 V	
Power	Adapter	10 ~ 30 V DC
	Dissipation	Typ. 18.0 W / Max. 23.0 W
	PoCXP	24 V DC, Minimum of two PoCXP cables required
Environmental	Ambient Operating: 0°C~40°C (Housing: 10°C~50°C) Storage: 40°C~70°C	
Mechanical / Weight	100 mm × 100 mm × 72 mm, 860 g	
API SDK	Vieworks Imaging Solution 7.X	
Optical Interface		
Lens Mount	M95 × 1 mm	
Sensor to Camera Front	9.50 mm (Optical Distance)	
Sensor Alignment		
Flatness	±25 μm	
x	±0.15 mm	
y	±0.15 mm	
z	±0.1 mm	

Table 5-1 Specifications of VT-16K5X2-E300A-64 and VT-16K5X2-H300A-256

5.3 Camera Block Diagram

VL series consists of three printed circuit boards (PCB), and its block diagram is shown below.

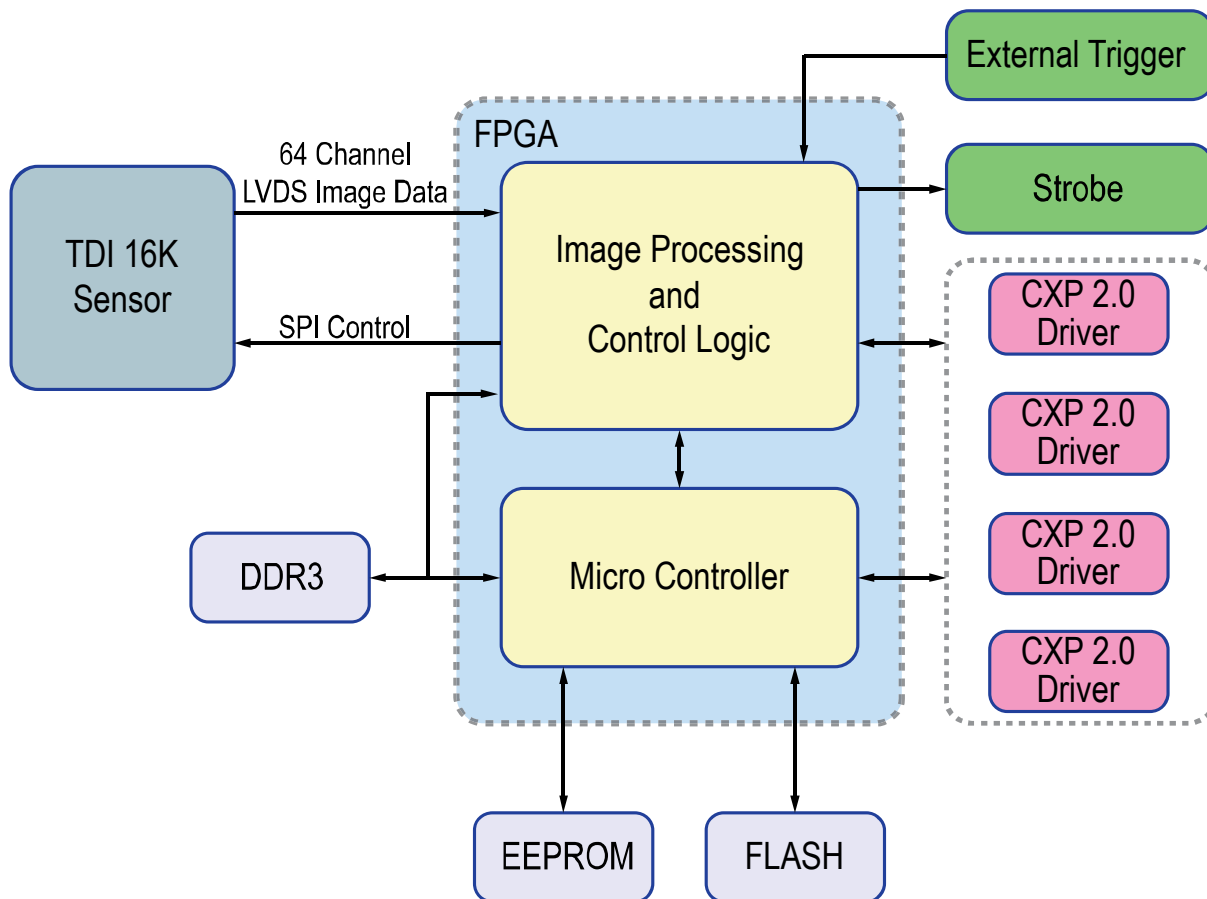

Figure 5-1 Camera Block Diagram

5.4 Quantum Efficiency

The following graphs show the quantum efficiency for the VT-16K5X2.

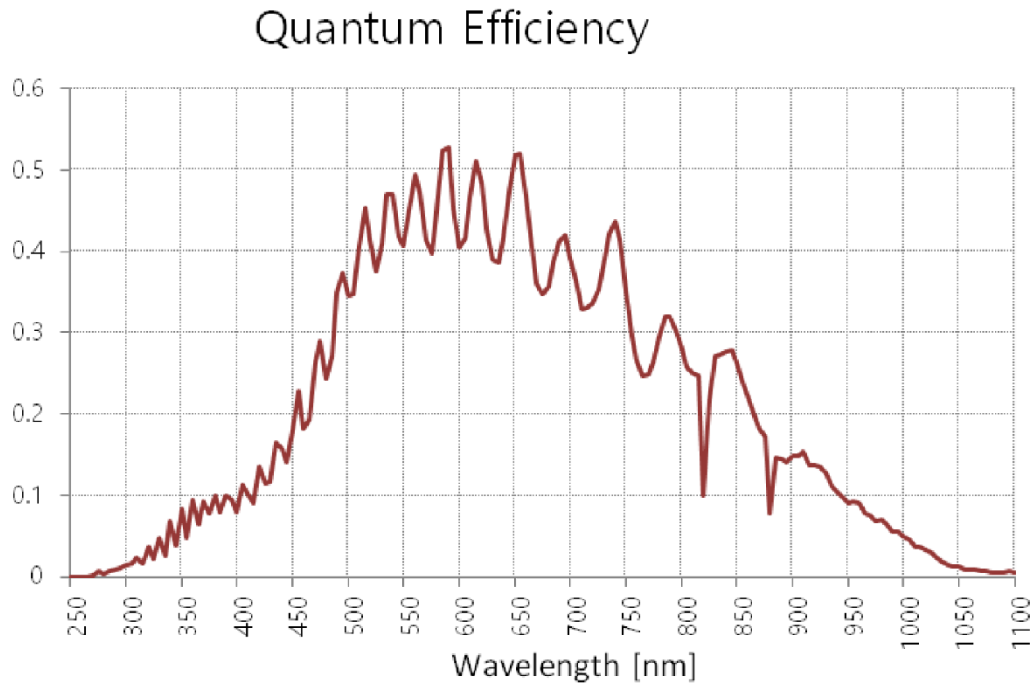

Figure 5-2 Quantum Efficiency

5.5 Mechanical Specification

The camera dimensions in millimeters are shown in the following figure.

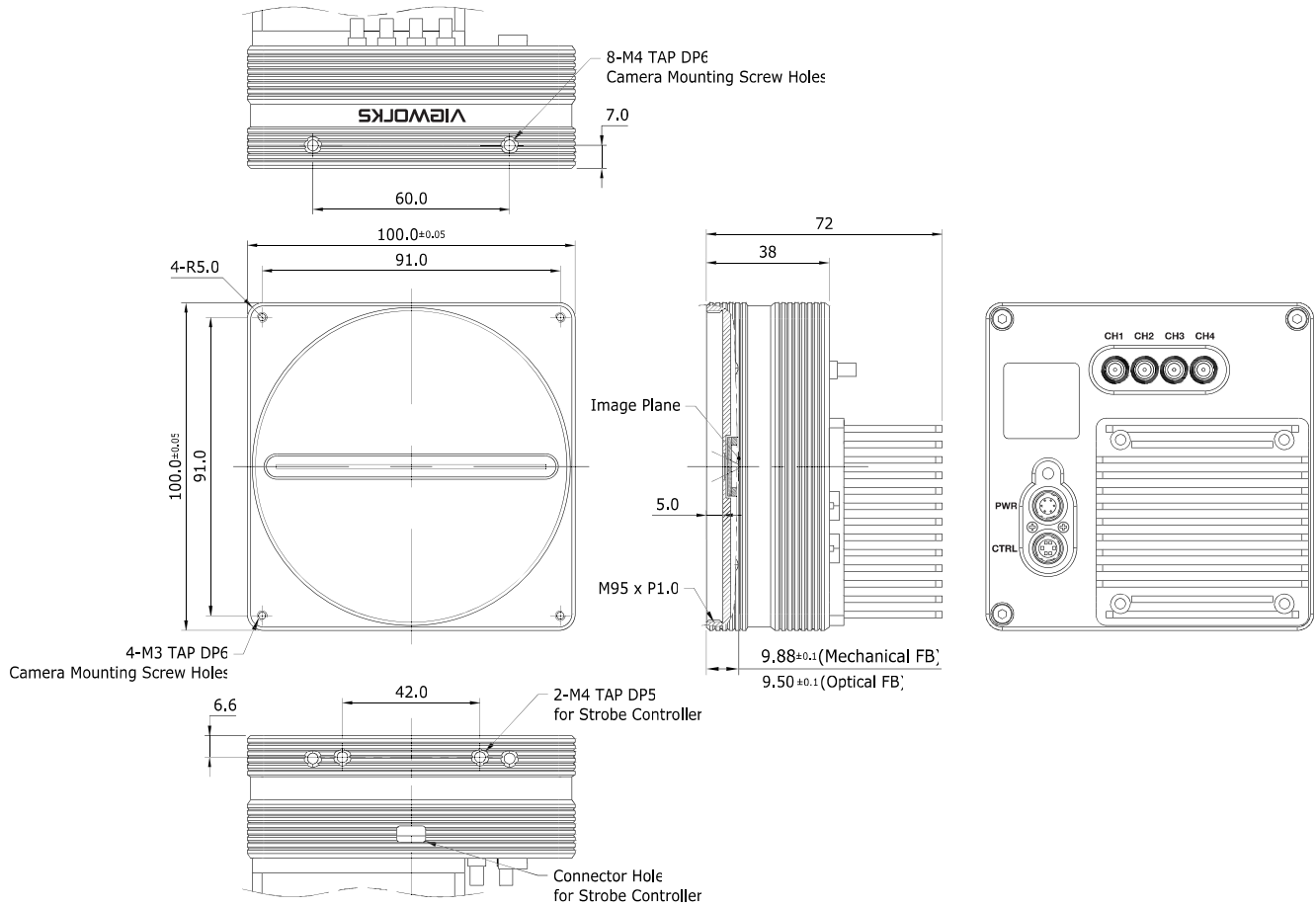

Figure 5-3 VL Series Mechanical Dimension

5.5.1 Camera Mounting and Heat Dissipation

You must mount the camera on a heat dissipation structure to maintain the temperature of the camera housing at 50°C or less. Given the low power consumption of the VL series camera, its housing temperature during operation will generally stay within the specified limits. However, overheating can occur if heat dissipation is restricted or if the camera is mounted on a severe environment. It is recommended to follow the general guidelines below when you mount the camera.

- In all cases, you should monitor the temperature of the camera housing and make sure that the temperature does not exceed 50°C. You can monitor the internal temperature of the camera by using the Device Temperature parameter.
- If your camera is mounted on a metal component in your system, this may provide sufficient heat dissipation.

Chapter 6. Connecting the Camera

The following instructions assume that you have installed a CoaXPress 2.0 Frame Grabber (hereinafter 'CXP-12 Frame Grabber') in your computer including related software. The procedure below also assumes that you may attempt to configure a link between a camera and CXP-12 Frame Grabber by using four coax cables. For more detailed information, refer to your CXP-12 Frame Grabber User Manual.

To connect the camera to your PC, follow the steps below.

1. Make sure that the power supply is not connected to the camera and your computer is turned off.
2. Plug one end of a coax cable into the CH1 of the CXP connector on the camera and the other end of the coax cable into the CH1 of the CXP-12 Frame Grabber in your computer. Then, connect the CH2, CH3 and CH4 of the CXP connector on the camera to the CH2, CH3 and CH4 of the CXP-12 Frame Grabber respectively using the other three coax cables.

- Connect the plug of the power adapter to the power input receptacle on the camera.
- Plug the power adapter into a working electrical outlet.

The power adapter isn't necessary to be connected if using Power over CoaXPress.



Caution!

To power a camera via PoCXP Frame Grabber, you must connect both the CH1 and CH2 channels of the camera to their respective connectors on the CXP-12 Frame Grabber.

3. Verify all the cable connections are secure.

6.1 Precaution to Center the Image Sensor

- Users do not need to center the image sensor as it is adjusted as factory default settings.
- When you need to adjust the center of the image sensor, please contact your local dealer or the manufacturer for technical assistance.

6.2 Installing Vieworks Imaging Solution

You can download the Vieworks Imaging Solution at <http://vision.vieworks.com>. You should perform the software installation first and then the hardware installation.

Chapter 7. Camera Interface

7.1 General Description

As shown in the following figure, four types of connectors and a status indicator LED are located on the back of the camera and have the functions as follows:

- | | |
|---------------------------------|---|
| ① CoaXPRESS Connector: | transmits video data and controls the camera. |
| ② Status LED: | displays power status and operation mode. |
| ③ 6-pin Power Input Receptacle: | supplies power to the camera. |
| ④ 6-pin Control Receptacle: | inputs external trigger signals and outputs strobe signals. |

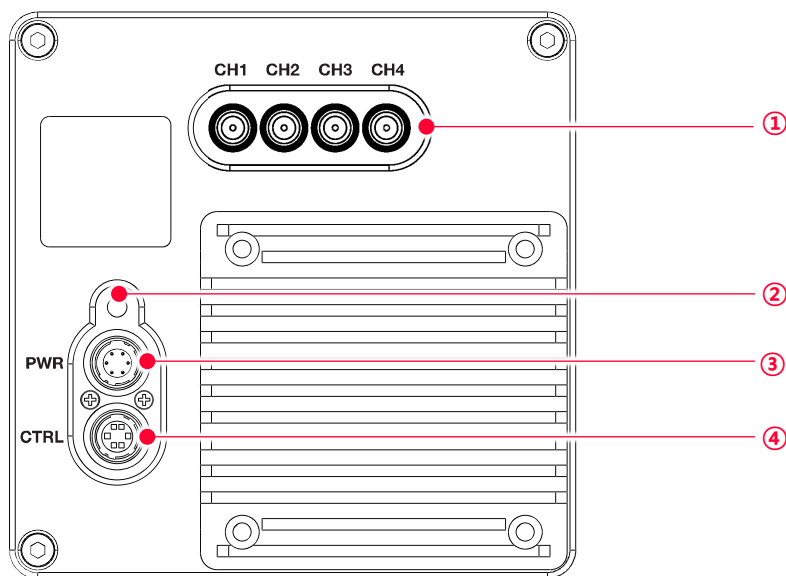

Figure 7-1 VT-16K5X2 Cameras' Back Panel

7.2 CoaXPress Connector

CoaXPress protocol includes an automatic link detection mechanism (Plug and Play) to correctly detect the camera to the CXP-12 Frame Grabber connection. The connection between the camera and CXP-12 Frame Grabber uses a coax (also known as 'coaxial') cable and provides up to 12.5 Gbps bit rate per cable.

7.2.1 Micro-BNC Connector

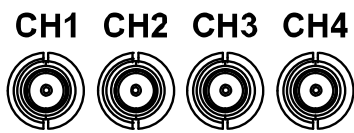

Figure 7-2 Micro-BNC Connector

The CoaXPress connector on the VT-16K5X2 cameras comply with the CoaXPress standard and the following table shows the channel assignments.

Channel	Max. Bit Rate per Coax	Type	PoCXP Compliant
CH1	12.5 Gbps	Master Connection	Yes
CH2	12.5 Gbps	Extension Connection	Yes
CH3	12.5 Gbps	Extension Connection	No
CH4	12.5 Gbps	Extension Connection	No

Table 7-1 Channel Assignments for Micro-BNC Connector



Note:

When you connect a camera to a CXP-12 Frame Grabber using coax cables, make sure to connect the cables to their correct channels. If you connect the CH1 of the CXP connector on the camera to a channel other than CH1 of the CXP-12 Frame Grabber, the camera may not transmit images properly or the communication between the computer and camera may fail.

7.3 Power Input Receptacle

The power input receptacle is a Hirose 6-pin connector (part # HR10A-7R-6PB). The pin assignments and configurations are as follows:

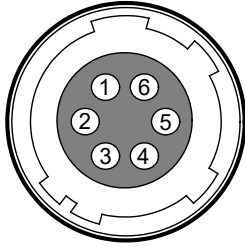

Figure 7-3 Pin Assignments for Power Input Receptacle

Pin Number	Signal	Type	Description
1, 2, 3	+ 12V DC	Input	DC Power Input
4, 5, 6	DC Ground	Input	DC Ground

Table 7-2 Pin Configurations for Power Input Receptacle



Note:

- A recommended mating connector for the Hirose 6-pin connector is the Hirose 6-pin plug (part # HR10A-7P-6S) or the equivalent.
- It is recommended that you use the power adapter, which has at least 3 A current output at 12 V DC $\pm 10\%$ voltage output (You need to purchase a power adapter separately.).

Precaution for Power Input



Caution!

- Make sure the power is turned off before connecting the power cord to the camera. Otherwise, damage to the camera may result.
- If the voltage applied to the camera is greater than specified in the specifications, damage to the camera may result.
- Make sure not to use the PoCXP and the power adapter together.

7.4 Control Receptacle

The control receptacle is a Hirose 6-pin connector (part # HR10A-7R-6SB) and consists of an

external trigger signal input and strobe output ports. The pin assignments and configurations are as follows:

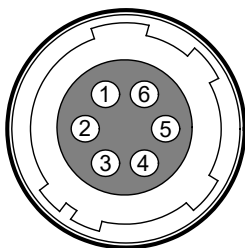

Figure 7-4 Pin Assignments for Control Receptacle

Pin Number	Signal	Type	Description
1	Trigger Input	Input	3.3 V ~ 5.0 V TTL input
2	Scan Direction Input	Input	3.3 V ~ 5.0 V TTL input
3	DC Ground	-	DC Ground
4	DC Ground	-	DC Ground
5	NC	-	Not Connected
6	Strobe Out	Output	3.3 V TTL Output Output resistance: 47 Ω

Table 7-3 Pin Configurations for Control Receptacle



Note:

A recommended mating connector for the Hirose 6-pin connector is the Hirose 6-pin plug (part # HR10A-7P-6P) or the equivalent.

7.5 Trigger/Direction Input Circuit

The following figure shows trigger signal input and TDI direction signal input circuit of the 6-pin connector. Transmitted trigger signal and TDI direction signal is applied to the internal circuit through a CMOS buffer with a good noise margin. The minimum trigger width that can be recognized by the camera is 1 μ s. If transmitted trigger signal is less than 1 μ s, the camera will ignore the trigger signal. An external trigger and TDI direction circuit example is shown below.

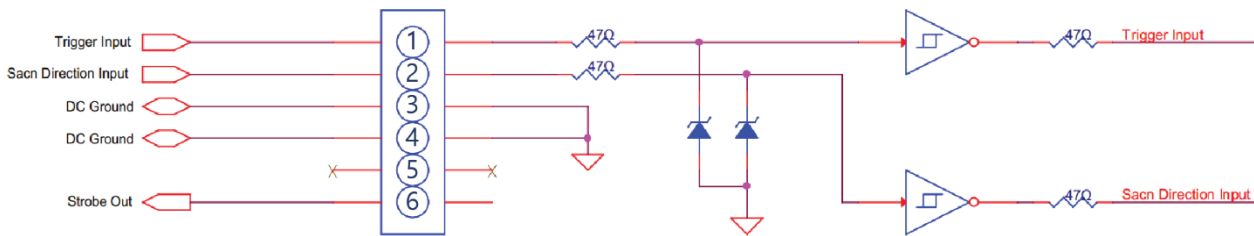

Figure 7-5 Trigger/Direction Input Schematic

7.6 Strobe Output Circuit

The strobe output signal comes out through a 3.3 V output level of Line Driver IC. A pulse width of the signal is synchronized with a Line Start trigger (shutter) of the camera (refer to 9.15 Digital I/O Control).

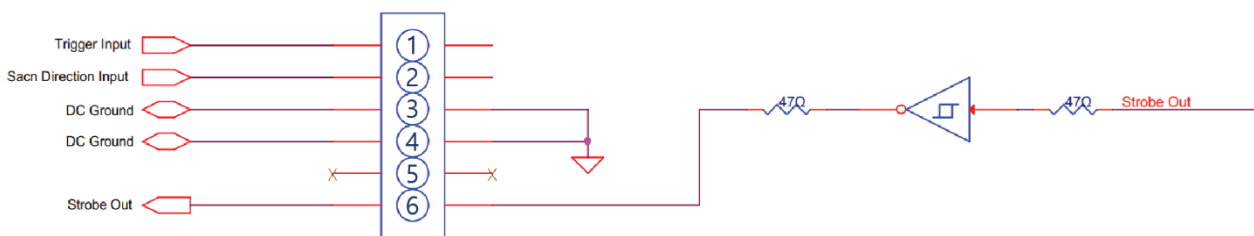

Figure 7-6 Strobe Output Schematic

Chapter 8. Acquisition Control

This chapter provides detailed information about the following elements involved with the image acquisition.

- Acquisition Start/Stop commands and Acquisition Mode parameter
- Line Start trigger
- Line Rate control
- Exposure Mode

8.1 Acquisition Start/Stop Commands and Acquisition Mode

The **Acquisition Start** command prepares the camera to acquire images. The camera cannot acquire images unless an **Acquisition Start** command has first been executed.

Executing an **Acquisition Stop** command terminates the camera's ability to acquire images.

A parameter called the **Acquisition Mode** has a direct bearing on how the **Acquisition Start** command operates. The VT-16K5X2 cameras only support **Continuous** for the **Acquisition Mode** parameter.

The **Acquisition Start** command will remain in effect until you execute the **Acquisition Stop** command. Once an **Acquisition Stop** command has been executed, the camera will not be able to acquire images until a new **Acquisition Start** command is executed.

8.2 Line Start Trigger

The **Trigger Selector** parameter is used to select a type of trigger and only the Line Start trigger is available on the VT-16K5X2 cameras. The Line Start trigger is used to begin line acquisition. Line Start trigger signals can be generated within the camera or may be applied externally by setting the **Trigger Source** parameter to Line0 or CC1. If a line start trigger signal is applied to the camera, the camera will begin to acquire images.

8.2.1 Trigger Mode

The main parameter associated with the line start trigger is the **Trigger Mode** parameter. The **Trigger Mode** parameter for the line start trigger has two available settings: **Off** and **On**.

Trigger Mode = Off

When the **Trigger Mode** parameter is set to **Off**, the camera will generate all required line start trigger signals internally, and you do not need to apply line start trigger signals to the camera. With the **Trigger Mode** set to **Off**, the camera will automatically generate a line start trigger signal whenever it receives an **Acquisition Start** command. The camera will automatically do this until executing an **Acquisition Stop** command.



Free-Run

When you set the **Trigger Mode** parameter to **Off**, the camera will generate all required trigger signals internally. When the camera is set this way, it will constantly acquire images without any need for triggering by the user. This use case is commonly known as “free-Run”.

The rate at which the line start trigger signals are generated may be determined by the camera's Acquisition Line Rate parameter.

- If the parameter is set to a value less than the maximum allowed line rate with the current camera settings, the camera will acquire images at the rate specified by the parameter setting.
- If the parameter is set to a value greater than the maximum allowed line rate with the current camera settings, the camera will acquire images at the maximum allowed line rate.

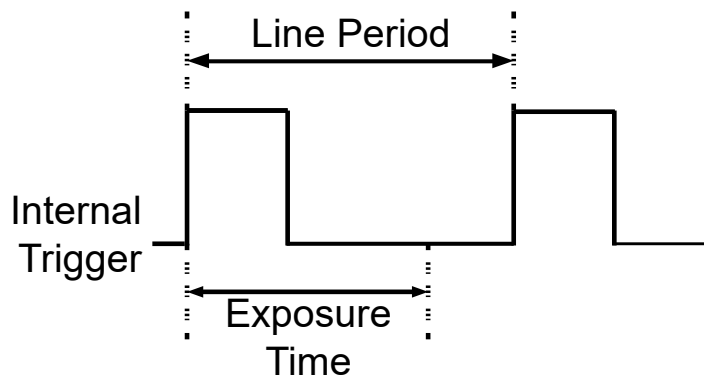

Figure 8-1 Trigger Mode = Off

Trigger Mode = On

When the **Trigger Mode** parameter is set to **On**, you must apply a line start trigger signal to the camera each time you want to begin an image acquisition. The **Trigger Source** parameter specifies the source signal that will act as the line start trigger signal.

The available settings for the **Trigger Source** parameter are:

- **Line0:** You can apply a line start trigger signal to the camera by injecting an externally generated electrical signal (commonly referred to as a hardware or external trigger signal) into the Control I/O Receptacle on the camera. Refer to 7.5 Trigger/Direction Input Circuit for more information.
- **LinkTrigger0:** You can apply a line start trigger signal via CH1 of the CXP Frame Grabber. For more information, refer to your CXP Frame Grabber User Manual.

If the **Trigger Source** parameter is set, you must also set the **Trigger Activation** parameter.

The available settings for the **Trigger Activation** parameter are:

- **Rising Edge:** Specifies that a rising edge of the electrical signal will act as the line start trigger.
- **Falling Edge:** Specifies that a falling edge of the electrical signal will act as the line start trigger.
- **Any Edge:** Specifies that both rising and falling edges of the electrical signal will act as the line start trigger.

When the **Trigger Mode** parameter is set to **On**, the camera's line rate can be controlled by manipulating the external trigger signal. At this point, it is important that you do not attempt to trigger images at a rate that is greater than the maximum allowed.

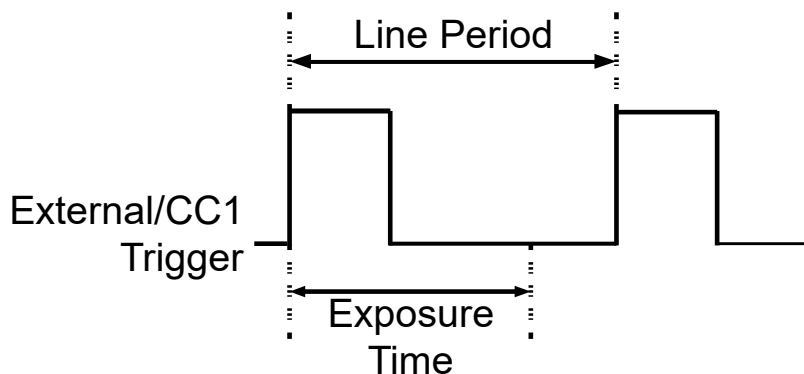

Figure 8-2 Trigger Mode = On

8.2.2 Using an External/CoaXPress Trigger Signal

If the **Trigger Mode** parameter is set to **On** and the **Trigger Source** parameter is set to

LinkTrigger0, you must apply an external or CoaXPress trigger signal to the camera to begin image acquisition.

To apply trigger signals via CH1 of the CXP Frame Grabber, you must set the Trigger Source parameter to LinkTrigger0. At that point, each time a proper CoaXPress trigger signal is applied to the camera by using the APIs provided by a CXP Frame Grabber manufacturer, the line start trigger signal will be applied to the camera.

For more information, refer to your CXP Frame Grabber User Manual.

To apply trigger signals via hardware (external), you must set the Trigger Source parameter to Line0. At that point, each time a proper electrical signal is applied to the camera, an occurrence of the line start trigger signal will be recognized by the camera.

A rising edge and/or a falling edge of the external or CoaXPress signal can be used to trigger image acquisition. The Trigger Activation parameter is used to select rising edge and/or falling edge triggering.

When the camera is operating under control of an external or CoaXPress signal, the period of trigger signal will determine the rate at which the camera is acquiring images:

$$\text{Line Rate(Hz)} = \frac{1}{\text{External/CoaXPress signal period in seconds}}$$

For example, if you are operating a camera with an external trigger signal period of 20 μs (0.00002 s):

So in this case, the line rate is 50 kHz.

8.2.3 Trigger Multiplier/Divider

With the Trigger Multiplier or Trigger Divider, you can modulate the period of the external trigger signal as desired. For example, if you supply the external trigger signal into the camera's I/O receptacle using the conveyor's encoder, the number of output pulses per revolution of the encoder is fixed. In this situation, you can modulate the period of the trigger signal received from the camera on the Trigger Multiplier or the Trigger Divider in the following manner, to match the pitch of the image in vertical direction.

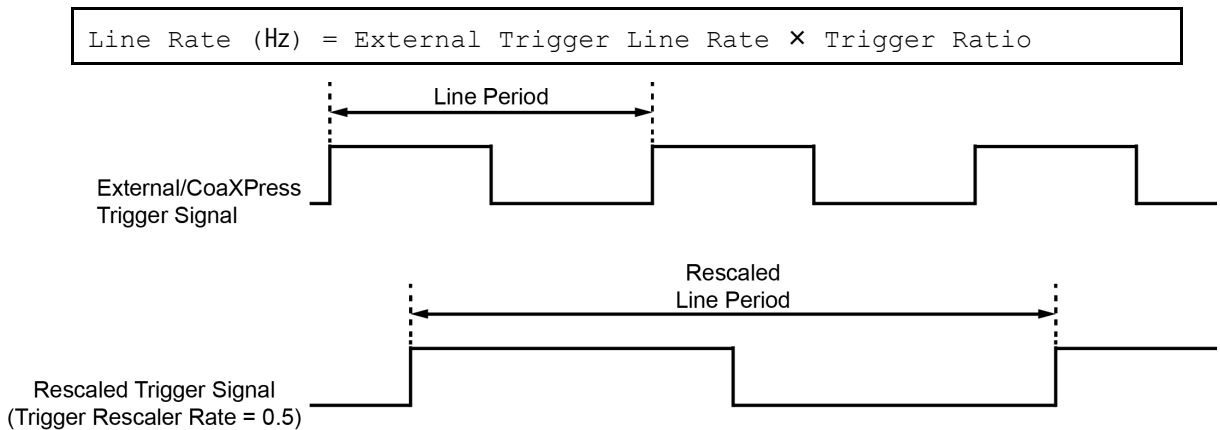

Figure 8-3 Trigger Ratio = 0.5

The XML parameters related to Trigger Multiplier or Trigger Divider are as follows.

XML Parameters	Value	Description
Acquisition Control	Trigger Multiplier	1 - 1024 Sets the trigger rescaler rate for converting trigger signals.
	Trigger Divider	1 - 1024 Sets the trigger rescaler rate for converting trigger signals.
	Trigger Ratio	0.000977 - 1024 Sets the trigger rescaler rate for converting trigger signals.
	TriggerRescaler FilterSize	Sets the rescaler filter factor to decrease the jitter of the external trigger signals.
	SIZE16	Sets the rescaler filter factor to 16.
	SIZE32	Sets the rescaler filter factor to 32.
	SIZE64	Sets the rescaler filter factor to 64.
	SIZE128	Sets the rescaler filter factor to 128.
	SIZE256	Sets the rescaler filter factor to 256.
	SIZE512	Sets the rescaler filter factor to 512.

Table 8-1 XML Parameters related to Trigger Multiplier/Divider Mode



Note:

To apply setting values successfully, it is necessary for Multiplier and Divider to input trigger signals several times at the beginning. Strobe outputs are delayed until the setting is applied well.

8.3 Maximum Allowed Line Rate

In general, the maximum allowed acquisition line rate on the camera may be limited by the following factor:

- The maximum allowed bit rate per cable and the number of CXP Link Configurations
- When the maximum allowed bit rate per cable is set to a high value (e.g., CXP6 supports up to 6.250 Gbps and CXP12 supports up to 12.500 Gbps), it will take less time to transfer acquired images from the camera to the CXP Frame Grabber in your computer.
- When the camera is set for a CXP Link Configuration that uses more channels, it can typically transfer data out of the camera faster. So, if the camera is set for a higher bit rate and number of channels, it will typically have a much higher maximum allowed line rate than when it is set for a lower bit rate and number of channels.

The maximum allowed line rates of the VT-16K5X2 cameras are as follows:

CXP Link Configuration	Maximum Line Rate at Full Resolution
CXP1 × 4	29 kHz
CXP2 × 4	59 kHz
CXP3 × 4	74 kHz
CXP5 × 4	119 kHz
CXP6 × 4	149 kHz
CXP10 × 4	238 kHz
CXP12 × 4	298 kHz

Table 8-2 Maximum Allowed Line Rates (8 bit)

Increasing the Maximum Allowed Line Rate

You may find that you would like to acquire line images at a rate higher than the maximum allowed with the camera's current settings. In this case, you must adjust one or more of the factors that can influence the maximum allowed line rate and then check to see if the maximum allowed line rate has increased.

- The time that it takes to transmit line images out of the camera is the main limiting factor on the line rate. You can decrease the line transmission time (and thus increase the maximum allowed line rate) by doing one or more of the following:
 - Use an 8 bit pixel data format rather than 12 bit pixel format. Images with fewer bits per pixel will take less time to transmit.
 - Use a smaller length of ROI. Decreasing the length of ROI means that the camera has less data to transmit and therefore the transmission time will decrease.
 - Use a CXP Link Configuration with a higher bit rate and number of channels.

Chapter 9. Camera Features

9.1 Device Scan Type

The VT-16K5X2 cameras have two different operation modes: **Areascan** and **Linescan**.

If the **DeviceControl** parameter is set to **Areascan**, the camera will operate as an area scan camera using two array of pixels. This mode is useful for aligning the camera to your target object. If the **DeviceControl** parameter is set to **Linescan**, the camera will operate as a line scan camera.

The commands related to the **DeviceControl** are as follows.

XML Parameters		Value	Description
DeviceControl	DeviceScanType	Areascan	Operates the camera in the Areascan Mode.
		Linescan	Operates the camera in the Linescan mode.

Table 9-1 XML Parameters related to Device Scan Type

On the **Areascan** mode, the XML parameters related to a height size of an images are as follows.

XML Parameters		Value	Description
ImageFormatControl	Height	256 – 16384	Sets the Height value in the Areascan mode.

Table 9-2 XML Parameters related to Device Scan Type

9.2 TDI Stages

In the Linescan mode, the TDI Stages parameter is used to determine the number of integration stages used by the camera. For example, if the TDI Stages parameter is set to 2, the camera will acquire images with 2× higher sensitivity.

The XML parameter related to TDI Stages is as follows.

XML Parameters	Value	Description
ImageFormatControl TDI Stages	64	Sets the number of TDI Stages to 64.
	128	Sets the number of TDI Stages to 128.
	192	Sets the number of TDI Stages to 192.
	256	Sets the number of TDI Stages to 256.

Table 9-3 XML Parameters related to TDI Stages

The number of available TDI Stages for each camera model is as follows.

Camera Model	The number of available TDI Stages
VT-16K5X2-E300A-64	64
VT-16K5X2-H300A-256	64/128/192/256

Table 9-4 The number of available TDI Stages for each camera model

9.3 Scan Direction

In the Linescan mode, the Scan Direction parameter is used to select the image sensor’s scan direction. You need to set the Scan Direction parameter to **Forward** if the object being imaged will pass the top of the camera, and then pass the bottom of the camera. On the contrary, you need to set the Scan Direction parameter to **Backward** if the object being imaged will pass the bottom of the camera, and then pass the top of the camera. When you set the Scan Direction parameter to **Line 1**, you can also select the scan direction by injecting an externally generated electrical signal (Low = Forward, High = Reverse) into the pin 2 of the Control I/O receptacle on the camera.

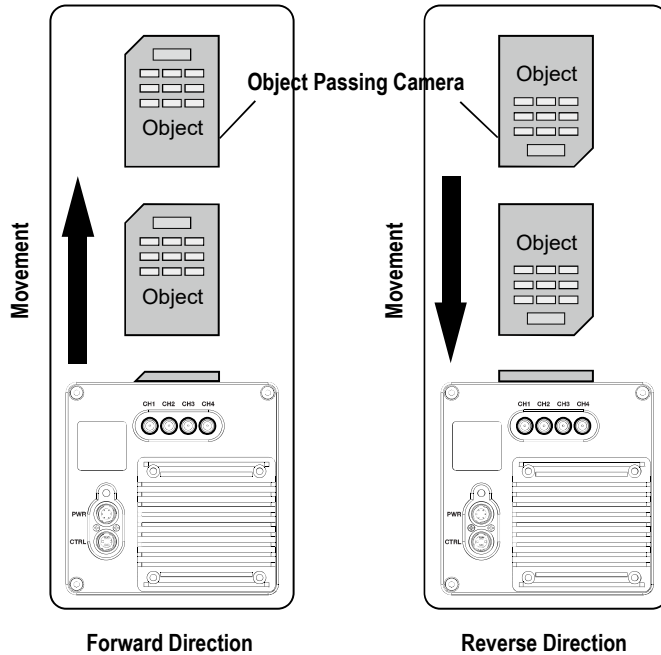

Figure 9-1 Scan Direction

XML Parameters		Value	Description
ImageFormatControl	Scan Direction	Forward	Scans images in the forward direction.
		Backward	Scans images in the backward direction.
		Line 1	Controls the direction depending on external signals

Table 9-5 XML Parameters related to Scan Direction

When you set the Scan Direction parameter to **Backward** in the Area mode, you can acquire vertically flipped images.

9.4 Region of Interest

The Region of Interest (ROI) feature allows you to specify a portion of the sensor lines. During operation, only the pixel information from the specified portion of the lines are read out of the sensor and transmitted from the camera to the frame grabber.

The ROI is referenced to the left end of the sensor array. The location and size of the ROI is defined by declaring the **Offset X** and **Width** settings. For example, suppose that you set the Offset X parameter to 24 and the Width parameter to 160 as shown in the figure below. With these settings, the camera will read out and transmit pixel values for pixels 24 through 184.

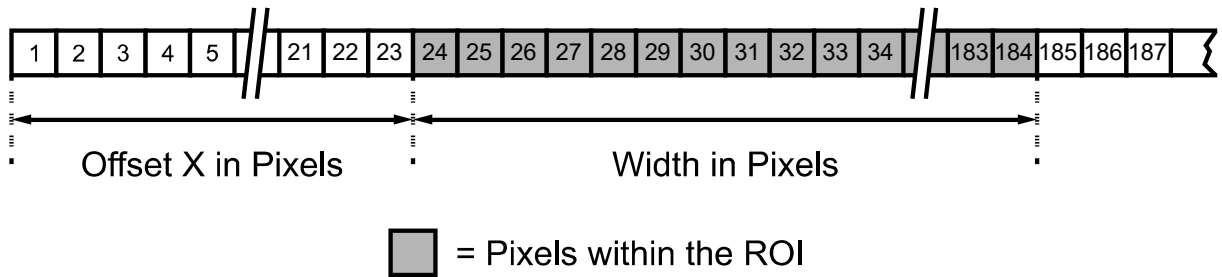

Figure 9-2 Region of Interest

The XML parameters related to ROI on the Linescan mode are as follows.

XML Parameters	Value †	Description	
ImageFormatControl	Width	64-16384	Sets the Width of the Image ROI.
	OffsetX	-	Sets the horizontal offset from the origin to the Image ROI.
	OffsetY	0	Sets the vertical offset from the origin to the Image ROI.

†: The unit for all parameters in this table is pixel.

Table 9-6 XML Parameters related to ROI

You can change the size of ROI by setting the **Width** parameters in the **Image Format Control** category. You can also change the position of the ROI origin by setting the **Offset X** parameter. Make sure that the **Width + Offset X** value is less than the **Width Max** value. You must set the size of the ROI first, and then set the Offset values since the **Width** parameter is set to its maximum value by default.

- The Width parameter must be set to a multiple of 32.
- The minimum allowed setting values for the ROI Width is 64.

**Caution!**

When you change the Image ROI settings after executing the Acquisition Start command, the camera may acquire abnormal images. Change the Image ROI settings after executing the Acquisition Stop command.

9.5 Binning

The Binning has the effects of increasing the level value and decreasing resolution by summing the values of the adjacent pixels and sending them as one pixel. The XML parameters related to Binning are as follows.

XML Parameters	Value	Description	
ImageFormat Control	BinningSelector	Sensor	Selects the Sensor for the binning engine. Applies the Binning in analog by the image sensor.
	BinningHorizontal Mode	Sum	Adds pixel values from the adjacent pixels as specified in the Binning Horizontal, and then sends them as one pixel.
	BinningHorizontal	×1, ×2	The number of horizontal pixels to combine together.
	BinningVertical Mode	Sum	Adds pixel values from the adjacent pixels as specified in the Binning Vertical, and then sends them as one pixel.
	BinningVertical	×1, ×2	The number of vertical pixels to combine together.

Table 9-7 XML Parameters related to Binning

You can acquire images of approximately quadruple sensitivity with simultaneous use of Horizontal Binning and Vertical Binning in the case of setting the Sensor Binning mode.

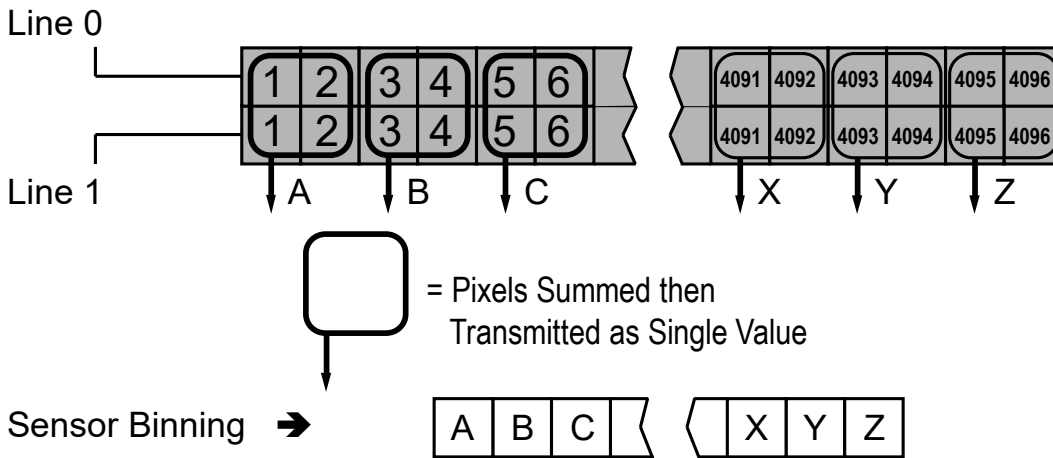

Figure 9-3 Sensor Binning

9.6 Pixel Format

You can determine the pixel format (8 bits, 10 bits or 12 bits) of image data transmitted from the camera by using the Pixel Format parameter.

The XML parameter related to Pixel Format is as follows.

XML Parameter	Description
ImageFormatControl	PixelFormat Sets the pixel format supported by the device.

Table 9-8 XML Parameter related to Pixel Format

The available pixel formats on the VT-16K5X2 cameras are as follows.

VT-16K5X2
Mono 8/10/12

Table 9-9 Pixel Format Values

9.7 Data ROI

The VT-16K5X2 camera provides the feature to correct Fixed Patter Noise in images by adjusting the parameters related to the Data ROI(Region of Interest). (Refer to 9.13 FPN Coefficients Control).

The XML parameters related to Data ROI are as follows.

XML Parameters	Value	Description
DataRoiControl	DataRoiSelector	FixedPatternNoise
	DataRoiOffsetX	-
	DataRoiOffsetY	-
	DataRoiWidth	-
	DataRoiHeight	-

Table 9-10 XML Parameters related to Data ROI

Only the pixel data from the area of overlap between the Data ROI by your settings and the Image ROI will be effective if you use the Image ROI and Data ROI at the same time. You can specify the numbers of lines to generate correction data by inputting the value in the Height parameter. A camera acquires images in the internal buffer as many as the specified number of lines and uses them for image correction.

The effective ROI is determined as shown in the figure below.

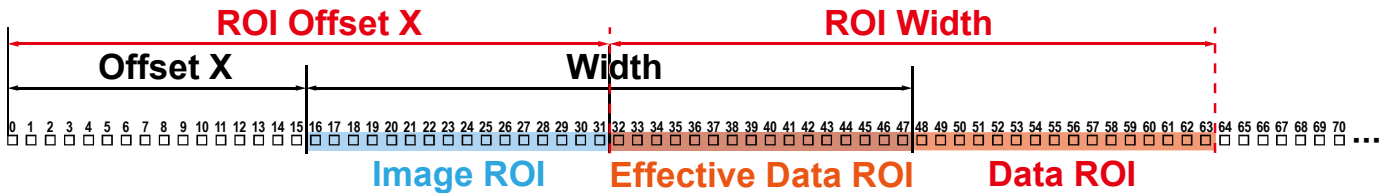

Figure 9-4 Effective Data ROI

9.8 Gain and Black Level

Increasing the **Gain** parameter increases all pixel values of the image. This results in a higher grey value output from the camera for a given amount of output from the image sensor.

1. Selects the Gain Control (**Analog All** or **Digital All** are available) to be adjusted by using the **Gain Selector** parameter.
2. Sets the **Gain** parameter to the desired value.

Adjusting the **Black Level** parameter will result in an offset to the pixel values output from the camera.

1. Selects the Black Level Control (**Digital All** is only available) to be adjusted by using the **Black Level Selector** parameter.
2. Sets the **Black Level** parameter to the desired value. The available setting range varies depending on the **Pixel Format** settings.

The XML parameters related to Gain and Black Level are as follows.

XML Parameters	Value	Description	
Analog Control	GainSelector	Analog All	Applies the Gain value to all analog channels.
		Digital All	Applies the Gain value to all digital channels.
Gain		1×, 2×, 3×, 4×	Sets an analog gain value. (1.25x, 1.75x, 2x, 3x, 4x)
		1.0× ~ 8.0×	Sets a digital gain value.
BlackLevelSelector	Digital All	Applies the Black Level value to all digital channels.	
BlackLevel	from -255 to 255	Sets a black level value (The setting range is based on the 8-bit pixel format.).	

Table 9-11 XML Parameters related to Gain and Black Level

9.9 Optical Black Clamp

The Optical Black Clamp function allows to correct changes of pixel values due to changes of sensor temperature. With this function, the VT-16K5X2 camera minimizes changes of pixel's level by temperature through removing offsets from temperature differences in real time.

The XML parameters related to Optical Black Clamp are as follows.

XML Parameters	Value	Description	
AnalogControl	OpticalBlack Clamp	Off	Deactivates the Optical Black Clamp function.
		On	Activates the Optical Black Clamp function.

Table 9-12 XML Parameters related to Optical Black Clamp

9.10 LUT

The Lookup Table (LUT) feature allows you to convert original image values to certain level values.

Luminance

Since it is mapped one to one for each level value, 12 bit output can be connected to 12 bit input. The LUT is in the form of table that has 4096 entries between 0 ~ 4095 and the VT-16K5X2 cameras provide a non-volatile space for LUT data storage.

You can determine whether to apply LUT. For more information about how to download LUT to the camera, refer to [Appendix B](#).

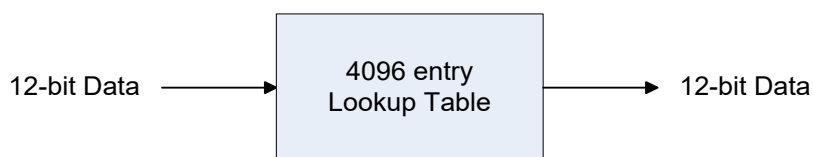

Figure 9-5 LUT Block

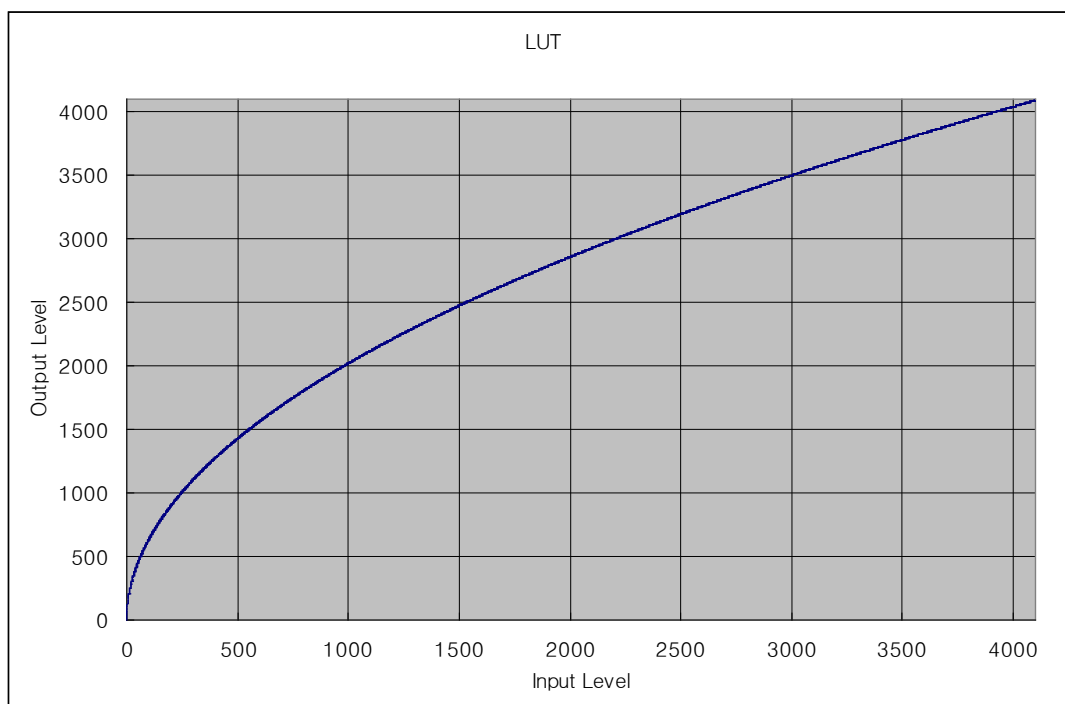

Figure 9-6 LUT at Gamma 0.5

The XML parameters related to LUT are as follows.

XML Parameters	Value	Description	
LUTControl	LUTSelector	Luminance	Luminance LUT
	LUTEnable	True	Activates the selected LUT.
		False	Deactivates the selected LUT.
	LUTValue	0 ~ 4095	Output value of the current LUT corresponding to the input value of LUT Index
	LUTSave	-	Saves the current LUT data to the non-volatile memory.
	LUTLoad	-	Loads the LUT data from the non-volatile memory.

Table 9-13 XML Parameters related to LUT

9.11 Dark Signal Non-uniformity Correction

In theory, when a digital camera acquires images in complete darkness, all of the pixel values in the image should be near zero and they should be equal. In practice, however, slight variations in the performance of the pixels in the sensor will cause some variations in the pixel values output from the camera when the camera is acquiring in darkness. This variation is known as Dark Signal Non-uniformity (DSNU). The VT-16K5X2 cameras provide the DSNU Correction feature.

The XML parameters related to DSNU are as follows.

XML Parameters	Value	Description
DSNU DSNUDataSelector	-	Chooses the DSNU data.
DSNU DSNUDataGenerate	-	Generates the DSNU data.
DSNU DSNUDataGenerateAll	-	Generates and saves the DSNU data for each Analog Gain setting value (1×, 2×, 3×, 4×).
DSNU DSNUDataSave	-	Saves the generated DSNU data in the non-volatile memory. The generated data by executing the DSNUDataGenerate parameter are saved in the volatile memory so that the data are lost if the camera is reset or if power is turned off. To use the data after the camera is powered on or reset, save them in the non-volatile memory.
DSNU DSNUDataLoad	-	Loads the DSNU data from the non-volatile memory into the volatile memory.

Table 9-14 XML Parameters related to DSNU

9.11.1 Generating and Saving User DSNU Correction Values

To generate and save user DSNU correction values, use the following procedure.



Note:

For optimum DSNU correction results, we recommend that you generate DSNU data after the temperature of the camera housing has been stabilized.

1. The camera will use the entire sensor when generating DSNU correction values. The DSNU correction value refers to the current setting values of the **OffsetX** and the **Width** range, therefore, we recommend to check setting of these values in advance.
2. Ensure that the camera will be acquiring line images in complete darkness by covering the camera lens, closing the iris in the lens, or darkening the room.
3. Begin acquiring line images either by setting the camera for the Free-Run mode or by supplying external trigger signals to trigger line acquisitions.
4. Generate DSNU correction values.
5. If you execute the **DSNU Data Generate** command,
 - a. The camera generates DSNU data according to the current Analog Gain setting value. The camera must acquire at least 1024 line images to create a set of DSNU correction values.
 - b. After completing 1024 line acquisitions, the generated DSNU correction values will be activated and saved in the camera's volatile memory.
 - c. To save the generated DSNU correction values in the camera's flash(non-volatile) memory, execute the **DSNU Data Save** command. The previous DSNU values for the current **Analog Gain** setting value saved in the memory will be overwritten.
6. If you change the **Analog Gain** setting value or want to load the existing values in the flash memory, execute the **DSNU Data Load** command.

9.12 Photo Response Non-uniformity Correction

In theory, when a line scan camera acquires images with the camera viewing a uniform light-colored target in bright light, all of the pixel values in the image should be near the maximum grey value and they should be equal. In practice, however, slight variations in the performance of the pixels in the sensor, variations in the optics, and variations in the lighting will cause some variations in the pixel values output from the camera. This variation is known as Photo Response Non-uniformity (PRNU). The VT-16K5X2 cameras provide the PRNU Correction feature and sixteen storage locations for PRNU correction values.

The XML parameters related to PRNU are as follows.

XML Parameters	Value	Description
PRNU PRNUCorrection	False	Disables the PRNU Correction feature.
	True	Enables the PRNU Correction feature.
PRNUSelector	Default, Space1-Space15	Selects a location to save PRNU data to or load PRNU data from.
PRNUTargetLevelAUTO	False	Select to set the PRNU Target Level manually.
	True	Select to set the PRNU Target Level automatically.
PRNUTargetLevel	0 - 255	Sets the PRNU Target Level (@ 8 bit pixel format).
PRNUDataGenerate	-	Generates the PRNU data.
PRNUDataSave	-	Saves the generated PRNU data in the non-volatile memory. The generated data by executing the PRNUDataGenerate parameter are saved in the volatile memory so that the data are lost if the camera is reset or if power is turned off. To use the data after the camera is powered on or reset, save them in the non-volatile memory.
PRNUDataLoad	-	Loads the PRNU data from the non-volatile memory into the volatile memory.

Table 9-15 XML Parameters related to PRNU

9.12.1 Generating and Saving User PRNU Correction Values

To generate and save user PRNU correction values, use the following procedure.



Note:

- We strongly recommend that you generate new PRNU correction values whenever you make a change to the optics or lighting or if you change the camera's line rate.
- For optimum PRNU correction results, we recommend that you generate DSNU correction values first before generating PRNU correction values.

1. The camera will use the entire sensor when generating PRNU correction values. The PRNU correction value refers to the current setting values of the **OffsetX** and the **Width** range, therefore, we recommend to check setting of these values in advance.
2. Place a uniform white target in the field of view of the camera. Adjust the optics, lighting and line rate as you would for normal operation. We recommend that you make adjustments to achieve the digital output level in a range from 100 to 200 (Gain: 1.00 at 8 bit).
3. Begin acquiring line images either by setting the camera for the Free-Run mode or by supplying external trigger signals to trigger line acquisition.
4. Set the Target Level.

To set the Target Level automatically, select the **Target Level AUTO** check box.

To set the Target Level manually, deselect the **Target Level AUTO** check box and input the target level in a range from 0 to 255.

5. Execute the **PRNU Generate** command to generate PRNU correction values.
6. The camera must acquire at least 1024 line images to create a set of PRNU correction values.
7. After completing 1024 line acquisitions, the generated PRNU correction values will be activated and saved in the camera's volatile memory.
8. To save the generated PRNU correction values in the camera's Flash (non-volatile) memory, specify a location to save by using the **PRNU Selector** parameter and execute the **PRNU Save** command. The existing values in the memory will be overwritten.

To ignore the generated PRNU correction values and load the existing values in the Flash memory, specify a location to load from by using the **PRNU Selector** parameter and execute the **PRNU Load** command.

9.13 FPN Coefficients Control

The FPN Coefficients Control feature provides function to correct Fixed Pattern Noise for acquired images. The VT-16K5X2 camera provides the feature to correct images after acquiring those, by adding Black Level to the value of the DSNU correction, or by multiplying Gain by the value of the PRNU correction.

The XML parameters related to FPN Coefficients Control are as follows.

XML Parameters		Value	Description
FPN Coefficients Control	DSNUCoefficient	-	Sets a value of Black Level to add to current value of the DSNU correction.
	DSNUCoefficientApply		Sets a value of Black Level to add to current value of the DSNU correction.
	PRNUCoefficient	-	Sets a Gain value to multiply by current value of the PRNU correction.
	PRNUCoefficientApply	-	Applies the value above to the value of the PRNU correction.

Table 9-16 XML Parameters related to FPN Coefficients Control

9.14 CXP Link Configuration

The VT-16K5X2 cameras must be connected to a CXP Frame Grabber installed in your computer via CoaXPress interface. CoaXPress interface allows you to connect a camera to a CXP Frame Grabber by using simple coax cabling and allows up to 12.5 Gbps data rate per cable. Four-channel VT-16K5X2 cameras support one master connection and three extension connections to configure a link. In compliance with the CoaXPress standard, the VT-16K5X2 cameras include an automatic link detection (Plug and Play) mechanism to correctly detect the camera to CXP Frame Grabber connections.

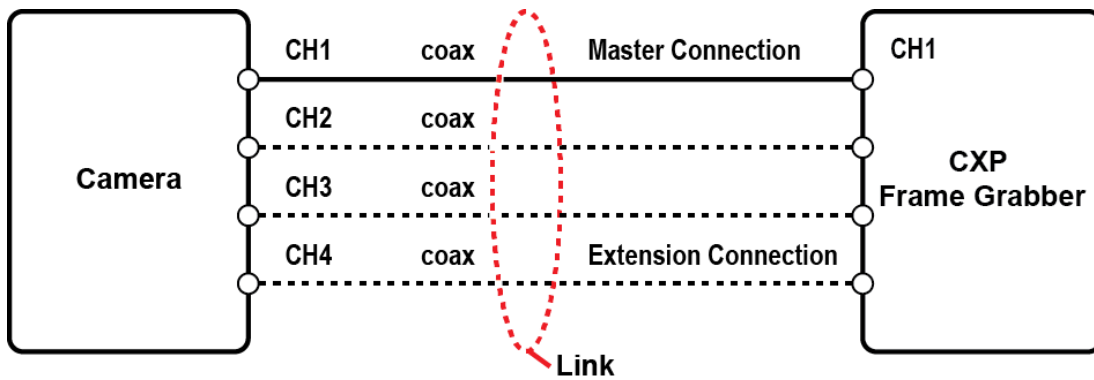

Figure 9-7 CXP Link Configuration

The XML parameters related to the link configuration between the camera and CXP Frame Grabber are located in the CoaXPress category under the Transport Layer Control as shown below.

XML Parameters		Value	Description
CoaXPress	CxpLinkConfiguration Preferred	Read Only	Displays bit rate and the number of connections to be set for the link configuration between the camera and Host (Frame Grabber) while discovering devices.
	CXPLinkConfiguration	CXP1_X1, X2, X4 CXP3_X1, X2, X4 CXP5_X1, X2, X4 CXP6_X1, X2, X4 CXP10_X1, X2, X4 CXP12_X1, X2, X4	Forcefully sets bit rate and the number of connections for the link configuration. e.g.) CXP12_X4: Four connections running at the maximum of CXP12 speed (12.5 Gbps)

Table 9-17 XML Parameters related to CXP Link Configuration

9.15 Digital I/O Control

The Control I/O receptacle of the camera can be operated in various modes.

The XML parameters related to Digital I/O Control are as follows.

XML Parameters	Value	Description	
DigitalIOControl	LineSelector	Line0	Sets the pin of No.1 among 6 pins of the Power Input and Control I/O receptacle to configure input signals for features related to counters, timers, or the others.
		Line1	Sets the pin of No.2 among 6 pins of the Power Input and Control I/O receptacle to configure input signals for Line1 in the Scan Direction parameters.
		Line2	Sets the pin of No.6 among 6 pins of the Power Input and Control I/O receptacle to configure about output signals.
LineMode	Input	Appears under either Line0 or Line1 is chosen.	
	Output	Appears under Line1 is chosen.	
LineInverter	FALSE	Disables inversion on the output signal of the line.	
	TRUE	Enables inversion on the output signal of the line.	
LineSource	Off	Disables the line output.	
	High	High output.	
	LinkTrigger	Outputs pulse signals set by LinkTrigger.	
	UserOutput0	Outputs pulse signals set by User Output Value.	
	Timer0Active	Outputs user-defined Timer signals as pulse signals.	
	Strobe 0	Outputs pulse signals set by Strobe0	
UserOutput Selector	User Output 0	Outputs pulse signals set by User Output Value.	
UserOutput Value	FALSE	Sets the bit state of the line to Low.	
	TRUE	Sets the bit state of the line to High.	
StrobeSelector	Strobe0	Sets Strobe Selector	
StrobeMode	Timed	Outputs pulse signals according to the Strobe Duration setting value.	
	TriggerWidth	Outputs pulse signals of which the pulse width is equal to the trigger signals applied to the camera.	
StrobeDelay	0~1000 μ s	Sets a delay to the current output signal in microseconds.	
StrobeDuration	1~1000 μ s	Sets a duration of pulse signal in microseconds when the Strobe Mode is set to Timed.	

Table 9-18 XML Parameters related to Digital I/O Control

Outputs pulse signals indicating the current exposure time.

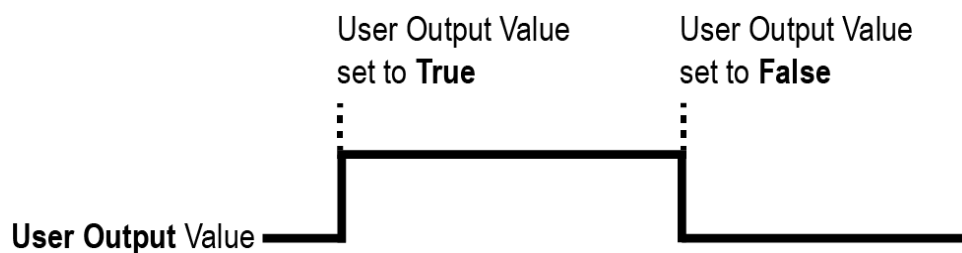

Figure 9-8 User Output

The camera can provide an Exposure Active output signal. The signal goes high when the exposure time for each frame acquisition begins and goes low when the exposure time ends as shown in the figure below. This signal can be used as a flash trigger and is also useful when you are operating a system where either the camera or the object being imaged is movable. Typically, you do not want the camera to move during exposure. You can monitor the Exposure Active signal to know when exposure is taking place and thus know when to avoid moving the camera.

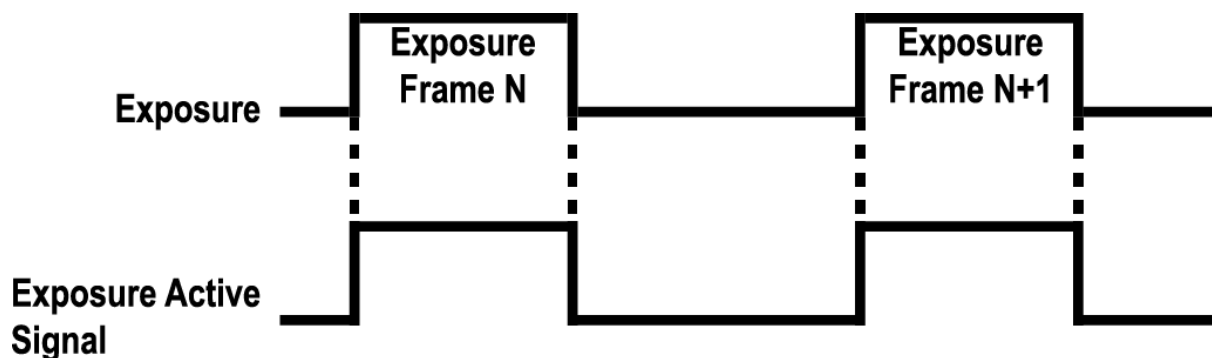

Figure 9-9 Exposure Active Signal

9.16 Debounce

The Debounce feature of the VT-16K5X2 cameras allows to supply only valid signals to the camera by discriminating between valid and invalid input signals. The Debounce Time parameter specifies the minimum time that an input signal must remain High or Low in order to be considered as a valid input signal. When you use the Debounce feature, be aware that there is a delay between the point where the valid input signal arrives and the point where the signal becomes effective. The duration of the delay is determined by the Debounce Time parameter setting value.

When you set the Debounce Time parameter, High and Low signals shorter than the setting value are considered invalid and ignored as shown in the figure below.

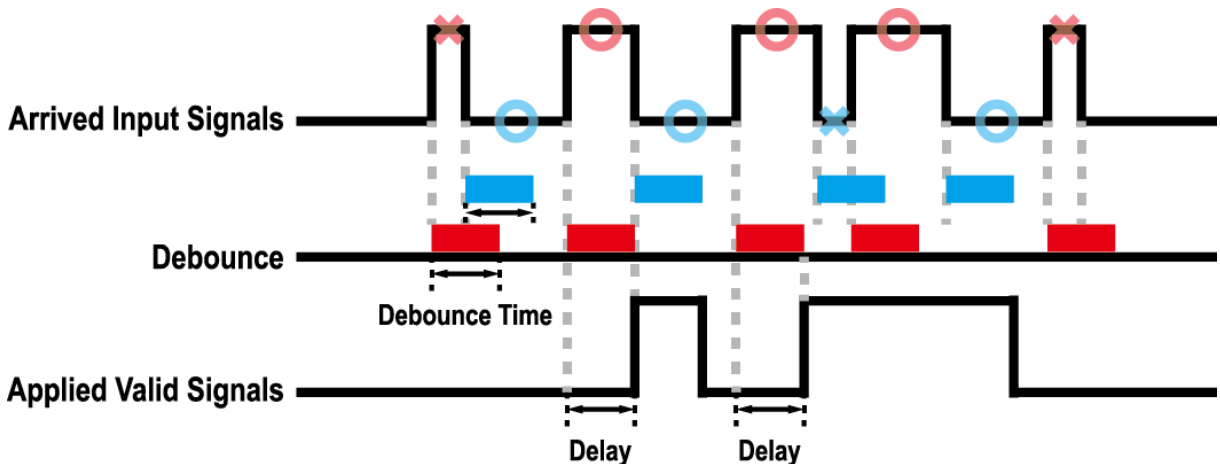

Figure 9-10 Debounce

9.17 Temperature Monitor

The camera has an embedded sensor chip to monitor the internal temperature.

The XML parameters related to Device Temperature are as follows.

XML Parameters	Value	Description
DeviceControl DeviceTemperature Selector	Mainboard	Sets a temperature measuring spot to the mainboard.
DeviceTemperature	-	Displays device temperature in Celsius.

Table 9-19 XML Parameters related to Device Temperature

9.18 Status LED

A LED is installed on the rear panel of the camera to inform the operation status of the camera.

LED status and corresponding camera status are as follows:

Status LED	Descriptions
Steady Red	Camera is not initialized.
Slow Flashing Red	A CXP link is not configured.
Fast Flashing Orange	Camera is checking a CXP link configuration.
Steady Green	A CXP link is configured.
Fast Flashing Green	Camera is acquiring images.

Table 9-20 Status LED

9.19 Test Pattern

To check whether the camera operates normally or not, it can be set to output test patterns generated in the camera, instead of image data from the image sensor. Four types of test patterns are available; images with different values in horizontal direction (Grey Horizontal Ramp), images with different values in diagonal direction (Grey Diagonal Ramp), moving images with different values in diagonal direction (Grey Diagonal Ramp Moving) and images with different values in horizontal direction output from the image sensor (Sensor Specific).

The XML parameter related to Test Pattern is as follows.

XML Parameter	Value	Description	
ImageFormatControl	TestPattern	Off	Disables the Test Pattern feature.
		GreyHorizontalRamp	Sets to Grey Horizontal Ramp.
		GreyDiagonalRamp	Sets to Grey Diagonal Ramp.
		GreyDiagonalRampMoving	Sets to Grey Diagonal Ramp Moving.
		SensorSpecific	Sets to the Test Pattern generated by the image sensor.

Table 9-21 XML Parameter related to Test Pattern

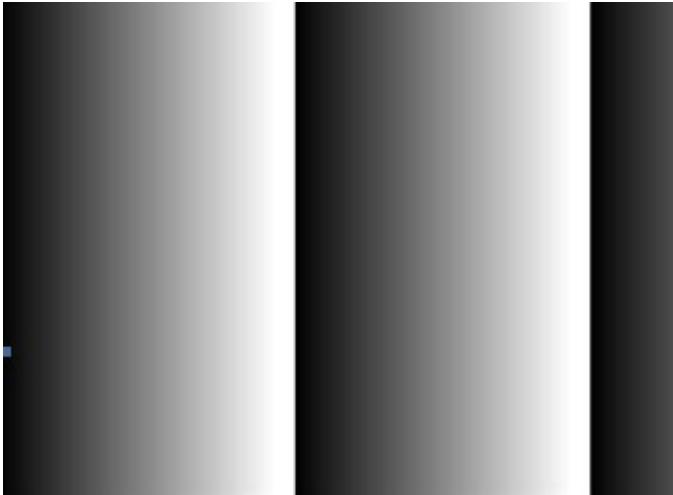

Figure 9-11 Grey Horizontal Ramp



Figure 9-12 Grey Diagonal Ramp

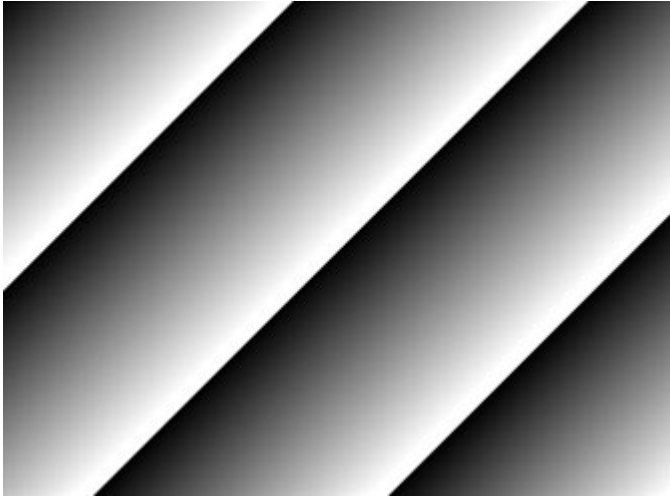

Figure 9-13 Grey Diagonal Ramp Moving

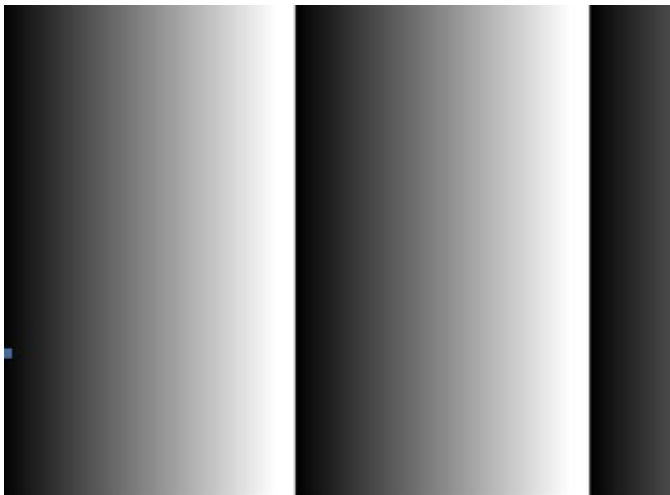

Figure 9-14 Sensor Specific

9.20 Reverse X

The Reverse X feature lets you flip images horizontally. This feature is available in almost all of operation modes of the camera, except for the Test Image mode.

XML Parameter	Value	Description
ImageFormatControl ReverseX	FALSE	Disables the Reverse X feature.
	TRUE	Flips images horizontally.

Table 9-22 XML Parameter related to Reverse X



Figure 9-15 Original Image



Figure 9-16 Reverse X Image

9.21 Counter Control

The VT-16K5X2 camera provides the Counter feature to count certain camera events. For example, you can verify the number of external trigger signals applied to the camera.

The XML parameters related to Counter Control are as follows.

XML Parameters		Value	Description
CounterAnd TimerControl	CounterSelector	Counter0	Selects a Counter to configure.
	CounterEvent Source	Off	Stops the Counter.
FrameActive		Counts the number of FrameActive signals.	
LineActive		Counts the number of Line Active signals.	
LinkTrigger		Counts the number of LinkTrigger signals.	
LinkTrigger0		Counts the number of LinkTrigger0 signals.	
Line0		Counter the number of external trigger signals.	
CounterEvent Activation	RisingEdge	Counts on the rising edge of the selected Event Source signal.	
	FallingEdge	Counts on the falling edge of the selected Event Source signal.	
CounterResetSource	Off	Disables the Counter Reset trigger.	
	Frame Active	Uses the Frame Active signal as Reset Source.	
	LinkTrigger	Uses the LinkTrigger signal as Reset Source.	
	Acquisition Active	Uses the Acquisition Active signal as Reset Source.	
	Line0	Uses the Line0 signal as Reset Source.	
CounterReset Activation	RisingEdge	Resets Counter on the rising edge of the selected Reset Source signal.	
	FallingEdge	Resets Counter on the falling edge of the selected Reset Source signal.	
	AnyEdge	Resets Counter on the rising/falling edge of the selected Reset Source signal.	
	LevelHigh	Resets the Counter if the level of the selected Reset Source signal is High.	
	LevelLow	Resets the Counter if the level of the selected Reset Source signal is Low.	
CounterReset	-	Resets the selected Counter and restarts.	
CounterValue	-	Displays the current value of the selected Counter.	
CounterValue AtReset	-	Displays the value of the Counter when it was reset by the Counter Reset command.	

Table 9-23 XML Parameters related to Counter Control (1)

XML Parameters	Value	Description	
CounterAnd TimerControl	CounterDuration	1 – 4294967295	Sets the duration or number of events to count before the Counter ends.
	CounterStatus	-	Displays the current status of the Counter.
	CounterTrigger Source	Off	Disables the Counter Trigger Source function.
		FrameActive	Uses the FrameActive signal as Trigger Source of Counter.
		LinkTrigger	Uses the LinkTrigger signal as Trigger Source of Counter.
		AcquisitionActive	Uses the AcquisitionActive signal as Trigger Source of Counter.
		Line0	Uses the Line0 signal as Trigger Source of Counter.
	CounterTrigger Activation	RisingEdge	Starts Counter on the rising edge of the selected Counter Trigger Source signal.
		FallingEdge	Starts Counter on the falling edge of the selected Counter Trigger Source signal.
		AnyEdge	Starts Counter on the rising/falling edge of the selected Counter Trigger Source signal.
		LevelHigh	Resets the Counter if the level of the selected Counter Trigger Source signal is High.
LevelLow		Resets the Counter if the level of the selected Counter Trigger Source signal is Counter.	

Table 9-24 XML Parameters related to Counter Control (2)

9.22 Timer Control

When the Sector parameter is set to Line1 and the Line Source parameter to Timer(Timer0Active), the camera can provide output signals by using the Timer. On the VT-16K5X2 camera, the Exposure Active, Frame Active, CC1, or external trigger signal is available as Timer source signal.

The XML parameters related to Timer Control are as follows.

XML Parameters	Value	Description
CounterAnd TimerControl	TimerSelector Timer0	Selects a Timer to configure.
	TimerDuration 1 - 60,000,000 μ s	Sets the duration of the Timer output signal to be used when Timer Trigger Activation is set to Rising / Falling Edge.
	TimerDelay 0 - 60,000,000 μ s	Sets the delay time to be applied before starting the Timer.
	TimerReset -	Resets the Timer and starts it again.
	TimerTrigger Source	Off LineTrigger FrameActive Line0
	TimerTrigger Activation	RisingEdge FallingEdge LevelHigh LevelLow

Table 9-25 XML Parameters related to Timer Control

For example, when the Timer Trigger Source is set to Exposure Active and the Timer Trigger Activation is set to Level High, the Timer will act as follows.

1. When the source signals set by the Timer Trigger Source parameter are applied, the Timer will start operations.
2. The delay set by the Timer Delay parameter begins to expire.
3. When the delay expires, the Timer signal goes high as long as the source signal is high.

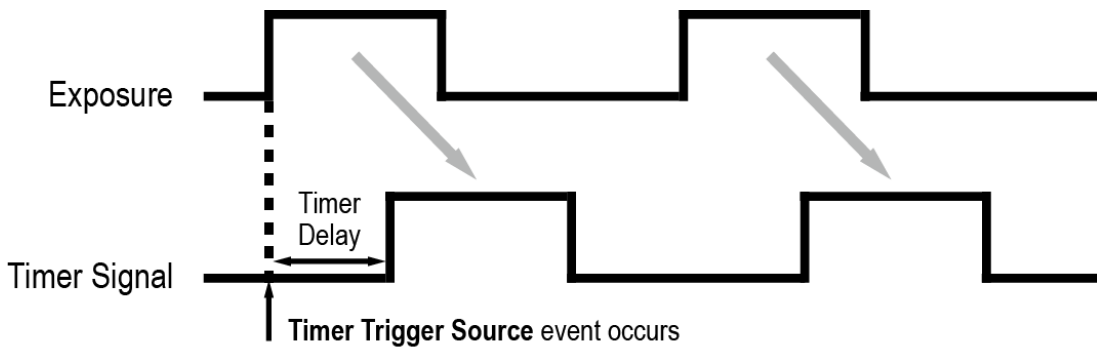

* **Timer Trigger Activation** is set to **Level High**.

Figure 9-17 Timer Signal

9.23 Device User ID

You can input user-defined information up to 32 bytes.

The XML parameter related to Device User ID is as follows.

XML Parameter	Description
DeviceControl DeviceUserID	Input user-defined information (32 bytes).

Table 9-26 XML Parameter related to Device User ID

9.24 Device Reset

Resets the camera physically to power off and on.

The XML parameter related to Device Reset is as follows.

XML Parameter	Description
DeviceControl Device Reset	Resets the camera physically.

Table 9-27 XML Parameter related to Device Reset

9.25 Field Upgrade

The camera provides a feature to upgrade the Firmware and FPGA logic through the Camera Link interface without disassembling the camera in the field. Refer to **Appendix A** for more details about how to upgrade.

9.26 User Set Control

You can save the current camera settings to the camera's internal Flash memory. You can also load the camera settings from the camera's internal Flash memory. The camera provides two setups to save and three setups to load settings.

The XML parameters related to User Set Control are as follows.

XML Parameters	Value	Description	
UserSetControl	UserSetSelector	Default	Selects the Factory Default settings.
		UserSet1	Selects the User Set1 settings.
		UserSet2	Selects the User Set2 settings.
UserSetLoad	-	Loads the User Set specified by User Set Selector to the camera.	
UserSetSave	-	Saves the current settings to the User Set specified by User Set Selector. The Default is a Factory Default settings and allowed to load only.	
UserSetDefault	Default	Applies the Factory Default settings when reset.	
	User Set1	Applies the User Set1 settings when reset.	
	User Set2	Applies the User Set2 settings when reset.	

Table 9-28 XML Parameters related to User Set Control

The camera settings stored in the Default can be loaded into the camera's workspace but cannot be changed. The settings set in the workspace will be lost if the camera is reset or powered off. To use the current setting values in the workspace after a reset, you must save the settings to one of the user spaces.

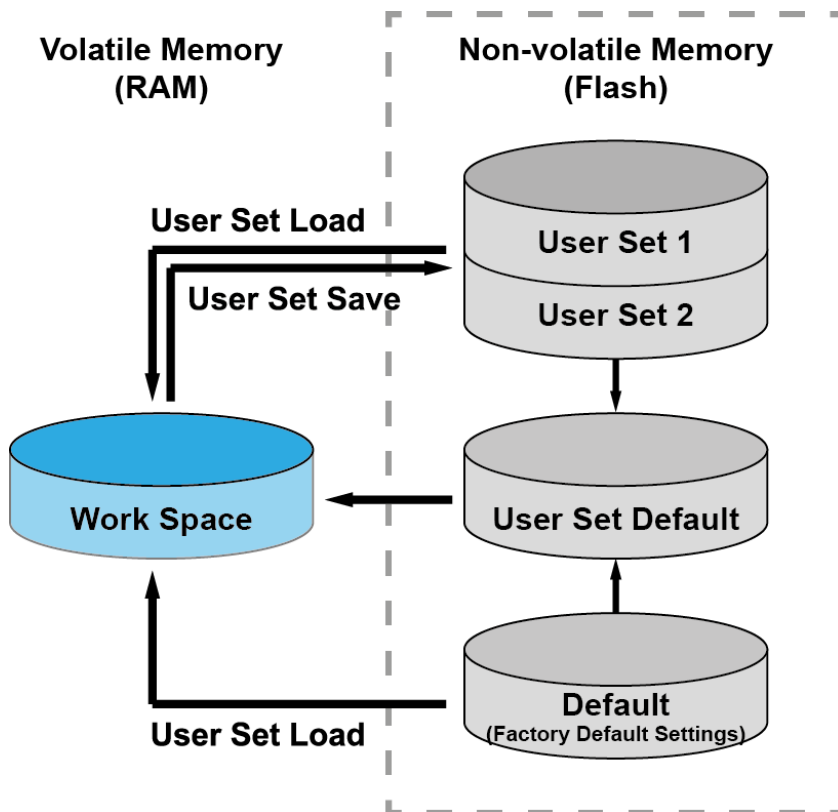

Figure 9-18 User Set Control

Chapter 10. Troubleshooting

When you have a problem with a Vieworks camera, please check the followings:

- If no image is displayed on your computer,
 - Ensure that all cable connections are secure.
 - Ensure that the power supply is properly connected.
 - Ensure that trigger signals are applied correctly when you operate the camera with trigger signals.

- If images are not clear,
 - Ensure the camera lens or glass is clean.
 - Check the lens aperture is adjusted properly.

- If images are dark,
 - Ensure the camera lens is not blocked.
 - Check the exposure time is set properly.

- If you identify abnormal operation or overheating sign,
 - Ensure the power supply is properly connected.
 - Stop using the camera when you notice smoke or abnormal overheating.

- If the Trigger Mode is not working correctly,
 - Ensure that the CC1 settings on the frame grabber are configured correctly when you use CC1 triggering.
 - Ensure that cable connections are secure when you use external triggering.

- If there is a communication failure between the camera and user's computer,
 - Ensure that the Camera Link cable connections are secure.
 - Ensure that you have configured a frame grabber in your computer and the camera is connected to the frame grabber correctly.

Appendix A. Field Upgrade

You can upgrade the MCU, FPGA and XML file of the camera by following the procedure below.

1. Run the Configurator and then click the **Configurator Plus** window > **Tools** > **Device Maintenance** to open the **Device Maintenance** window.
2. Select the **PKG** tab, click the **...** button of the **File Path** item's left, select the MCU, FPGA or XML upgrade file, and then click the **Download** button.

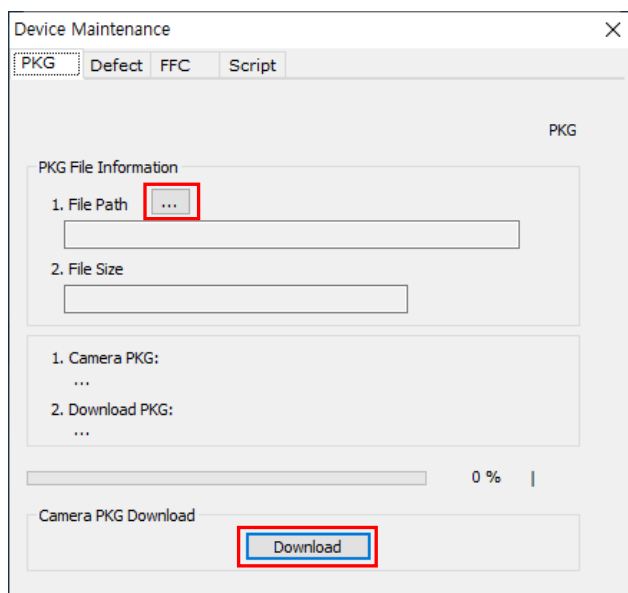

3. The camera begins downloading the upgrade file and the downloading status is displayed at the bottom of the window.
4. After completing the download, click the **OK** button to close the confirmation.

Appendix B. LUT Download

You can create LUT data in two different ways; by adjusting the gamma values on the gamma graph provided in the program and then downloading the data or by opening a CSV file (*.csv) and then downloading the data.

B.1 Gamma Graph Download

1. Run Vieworks Imaging Solution 7.X and click the **Configure** button to display the window as shown below. Select the **LUT** tab, and then select **Luminance** from the **Type** dropdown list.
2. Set a desired value in the **Gamma** input field and click the **Apply** button.

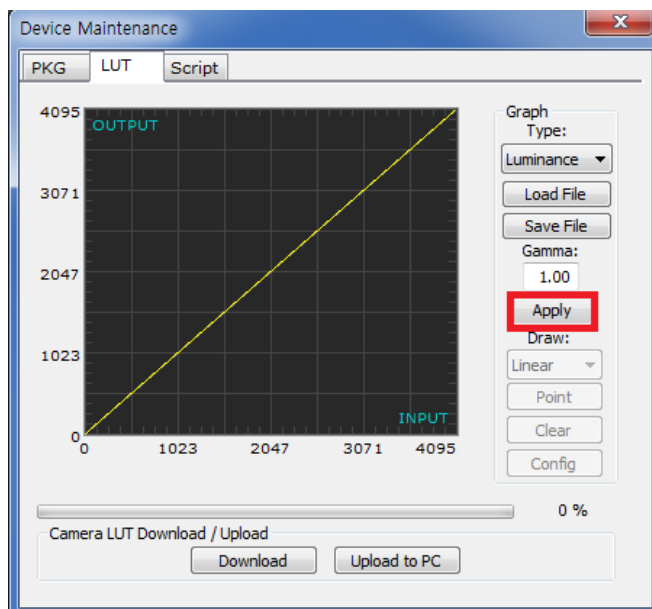

3. Click the **Download** button to download the gamma values to the camera.

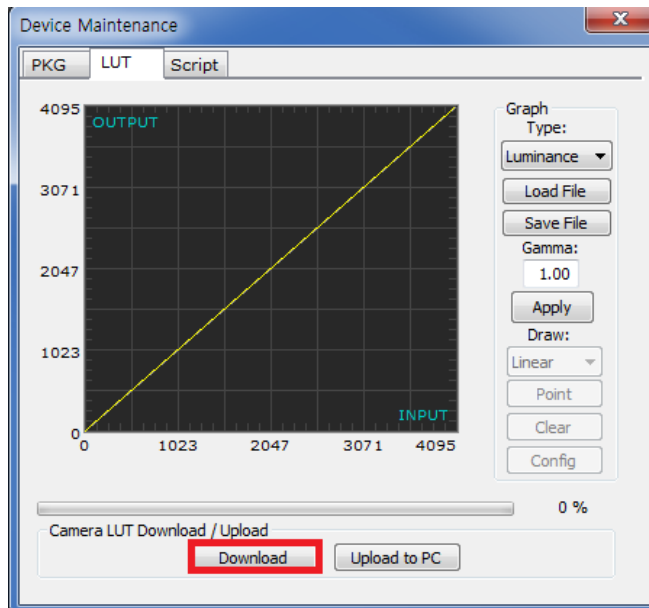

4. After completing the download, click the **OK** button to close the confirmation.

B.2 CSV File Download

1. Create the LUT table in Microsoft Excel format as shown in the left picture below and save as a CSV file (*.csv). The picture in the right shows the created file opened in Notepad. Once the file has been created completely, change the .csv file extension to .lut. Keep in mind the following rules when creating the file.

- Lines beginning with ':' or '--' are treated as notes.
- Based on the input values, make sure to record from 0 to 4095.

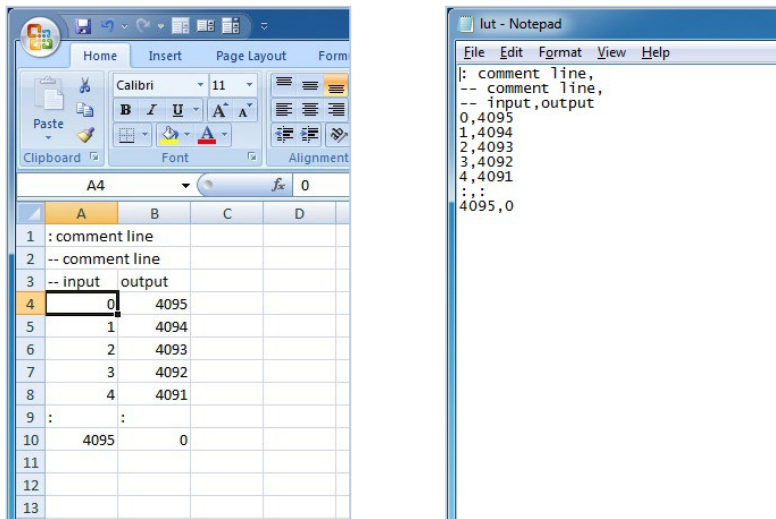

2. Run Vieworks Imaging Solution 7.X and click the Configure button to display the window as shown below. Select the LUT tab, select Luminance from the Type dropdown list, and then click the **Load File** button.

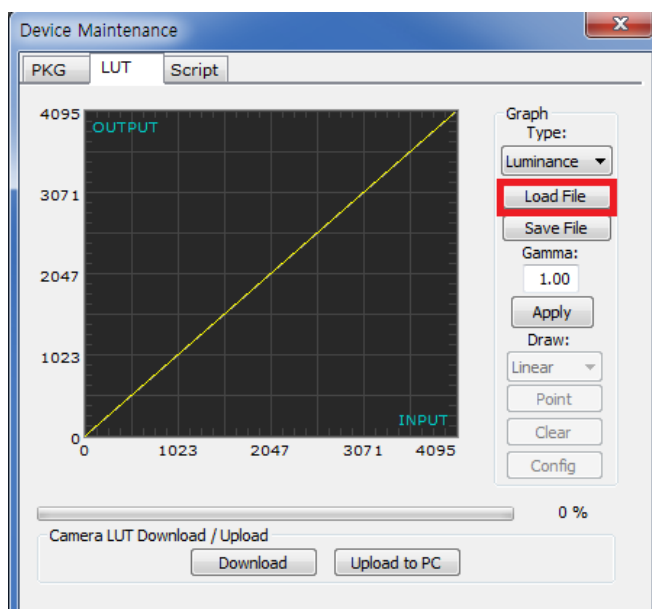

3. Search and select the created LUT file and click the **Open** button.

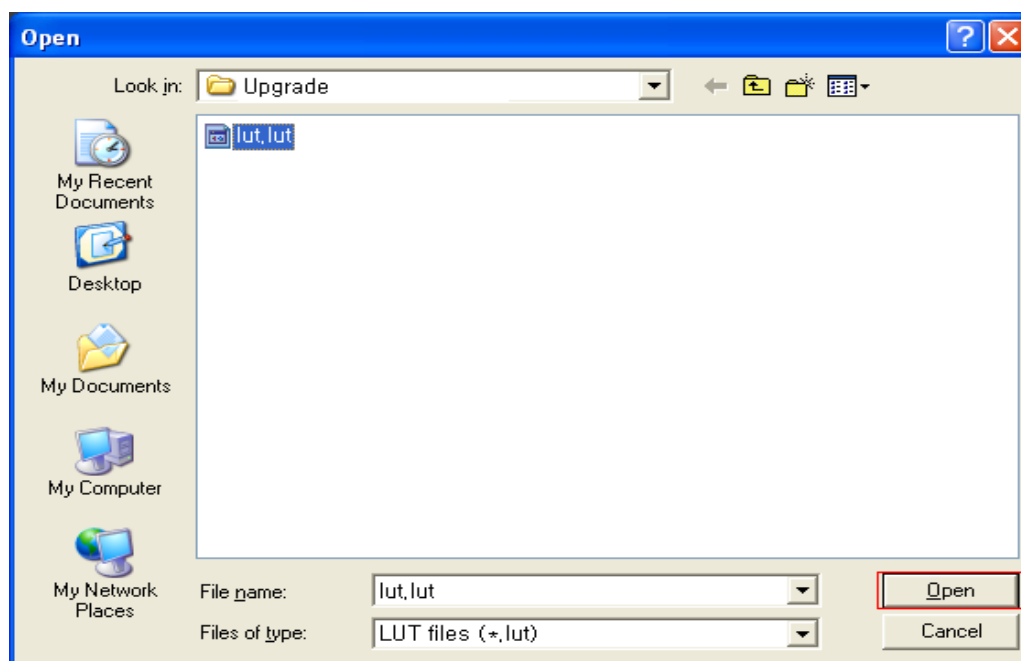

4. Click the **Download** button. After completing the download, click the **OK** button to close the confirmation.

Appendix C. Index

6

6-pin connector..... 30, 31

A

acquisition control.....33

Acquisition Mode parameter33

Acquisition Start command.....33

Acquisition Stop command.....33

any edge.....36

application.....6

Areascan mode41

B

back panel.....28

Backward parameter.....43

block diagram22

C

camera ON&OFF68

camera's temperature, parameters60

CC1 trigger signal 34

color camera's pixel formats47

Configurator 6

connecting a camera..... 26

CXP connector 28, 29

D

dimension 24

direction input.....32

downloading Vieworks Imaging Solution 27

downloading VIS..... 27

DSNU data, generation 52

E

Effective Data ROI, determination..... 48

external trigger signal..... 37

F

falling edge	36
Fixed Pattern Noise.....	56
Forward parameter	43
FPN	56
FPN coefficients	56
FPN correction.....	56
Free-Run.....	34

G

gain value, setting	49
generating line start trigger signals.....	34

H

heat dissipation	25
Hirose	30, 31
Hirose 6-pin connector	30, 31
housing.....	25

I

inputting information of user's choice.....	68
---	----

L

LED status	61
Line 1 parameter	43
line rate for each model	40
Line0 signal.....	34
Linescan mode.....	41, 42

M

monochrome camera's pixel formats	47
mounting	25

N

number of Integration Stage	42
number of TDI Stage	42

O

offset to pixel.....	49
offset value, setting	49

P

preface.....	3, 6
PRNU.....	54
product	6

Q

quantum efficiency.....	23
-------------------------	----

R

reset physically68

rising edge36

S

scan direction of an image sensor43

schematic diagram32

signal period of trigger38

specification21

strobe output32

T

Target Level AUTO55

TDI Stages parameter42

Trigger Activation parameter36

trigger input32

Trigger Mode parameter34

Trigger Selector parameter34

Trigger Source parameter36

V

Vieworks Imaging Solution download 27

VIS 27

VIS installation 27

VT-16K5X2-E300A-64 41

VT-16K5X2-E300A-64 specification 21

VT-16K5X2-H300A-256 41

VT-16K5X2-H300A-256 specification 21

X

XML parameter

BalanceWhiteAuto 49

BinningHorizontal 46

BinningHorizontalMode 46

BinningSelector 46

BinningVertical 46

BinningVerticalMode 46

CounterAndTimeControl 66, 67

CounterDuration 66

CounterEventActivation 66

CounterEventSource 66

CounterReset 66

CounterResetSource 66

CounterSelector 66

CounterStatus 66

CounterValue 66

CounterValueAtReset 66

DataRoiHeight 48

DataRoiOffsetX 48

DataRoiOffsetY 48

DataRoiSelector 48

DataRoiWidth 48

Device Reset 68

DeviceScanType 41

DeviceTemperature 60

DeviceTemperatureSelector 60

DeviceUserID 68

DigitalIOControl 58

DSNUCoefficient 56

DSNUCoefficientApply 56

DSNUDataGenerate 52

DSNUDataGenerateAll 52

DSNUDataLoad	52	PRNUDataSave	54
DSNUDataSave	52	PRNUTargetLevel.....	54
DSNUDataSelector	52	PRNUTargetLevelAUTO.....	54
FallingEdge	66	ReverseX.....	64
FixedPatternNoise	48	RisingEdge	66
FPNCoefficientsControl	56	ROI setting	44
FrameActive.....	58	Scan Direction	43
GreyDiagonalRamp	61	SensorSpecific.....	61
GreyDiagonalRampMoving.....	61	TDI Stages	42
GreyHorizontalRamp	61	TestPattern	61
Line 0	58	Timer0Active	58
Line 1	58	TimerDelay	67
LineActive.....	58	TimerDuration.....	67
LineActive, (CounterEventSource).....	66	TimerReset	67
LineInverter.....	58	TimerSelector	67
LineSelector.....	58	TimerTriggerActivation.....	67
LineSource	58	TimerTriggerSource.....	67
LineTrigger0.....	66	Trigger Ratio	39
Mainboard	60	TriggerRescalerFilter	39
OffsetX	44	UserDefault	69
OffsetY	44	UserOutput0.....	58
OpticalBlackClamp	49	UserOutputValue	58
PixelFormat	47	UserSet1	69
PRNU Selector.....	54	UserSet2	69
PRNUCoefficient	56	UserSetControl.....	69
PRNUCoefficientApply.....	56	UserSetLoad	69
PRNUCorrection	54	UserSetSave.....	69
PRNUDataGenerate.....	54	UserSetSelector.....	69
PRNUDataLoad	54		

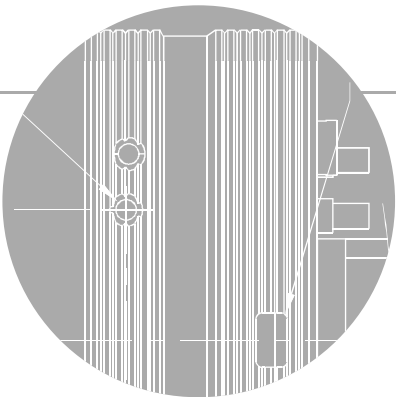
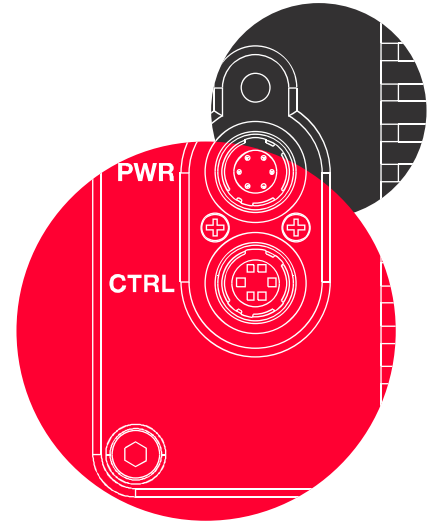
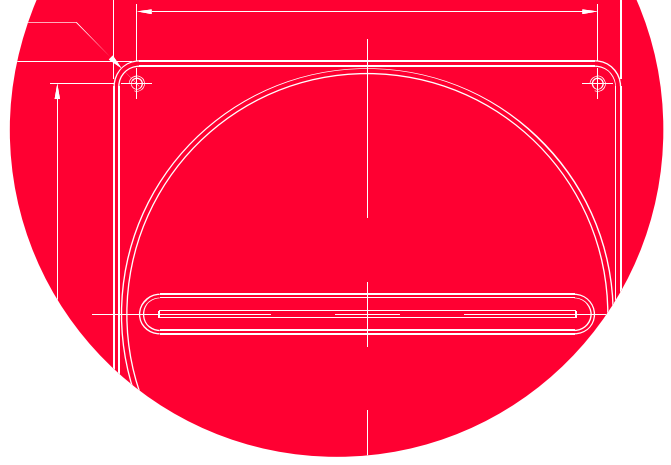

Vieworks Co., Ltd.

41-3, Burim-ro, 170beon-gil,
Dongan-gu, Anyang-si, Gyeonggi-do
14055 Republic of Korea

Tel: +82-70-7011-6161

Fax: +82-31-386-8631

<http://vision.vieworks.com>

vision@vieworks.com